

RADIOTRONICS

AMALGAMATED WIRELESS VALVE CO. PTY. LTD.

BOX No. 2516BB, G.P.O., SYDNEY

TECHNICAL BULLETIN No. 109

24th January, 1941

In this issue:—

	Page		Page
Radiotron Phototubes	1	Index for 1940	14
Radiotron News	14	Revised Phototube Characteristics	14
Radiotron Designer's Handbook	14	Receiving Type Manual	14

RADIOTRON PHOTOTUBES*

Radiotron phototubes are of two principal groups—gas types and vacuum types. Most of the gas types are designed primarily for sound reproduction, but their high sensitivity makes these types suitable for many relay applications. All of this group employ either the S1 or the S2 photoactive surface. These surfaces give high response to red and near infrared radiation. Included in this group are the 868, a tube long used for sound reproduction; the 918, a tube similar to the 868, but having improved sensitivity; the 923, a tube similar to the 918 in a short bulb; the 927, a small tube especially for 16-mm sound equipment; and the 920, a twin tube for use in push-pull sound reproduction from a double sound track. Other gas types more especially designed for relay applications are the 921, a compact cartridge-type tube; the 924, a small end-on type with cathode facing the end of the bulb; and the 928, a tube with a cathode arranged to respond to light from many directions.

The vacuum-phototube group is of primary interest to the designer of light-operated relays and light-measuring equipment. Tubes in this group are made with four different kinds of surfaces. Among these four surfaces, the S3 surface used in the 926 has the spectral response closest to that of the eye. This tube is, therefore, of particular interest for colorimetric work. The S4 surface of the 929 has an exceptionally high response to blue and blue-green radiation and a negligible response to red radiation. This feature is of importance in flame-control work where it is desired that the tube respond to the flame and not to heated objects in it.

All other Radiotron vacuum types have the same S1 or S2 surfaces utilized in gas types. These vacuum types differ chiefly in structural details. They include the 917 and the 919, two exceptionally low-leakage types which are alike except that the anode is brought out to a top cap in the 917, and the cathode to the top cap in the 919; the 922, a compact cartridge type; and the 925, a tube with short bulb.

Additional information on the choice of a phototube type for a specific relay or measurement circuit is given under APPLICATION. Inquiries regarding the use of any Radiotron phototube will be welcomed.



*Reprinted from R.C.A. Leaflet by courtesy of R.C.A. Manufacturing Co. Inc.



PHOTOTUBE CONSIDERATIONS

A phototube consists principally of two electrodes in an evacuated glass envelope. One electrode, the cathode, emits electrons when its sensitized surface is exposed to light or other radiant energy. These electrons are drawn to the second electrode, the anode, because this electrode is operated at a positive potential. The number of electrons emitted by the cathode depends on the wavelength and the amount of radiant energy falling on it. The phototube thus provides an electric current whose magnitude can be controlled by light or other radiant energy.



Sensitivity of Phototubes

The sensitivity of a phototube is basically defined as the quotient of the current through the tube by the radiant flux received by the cathode. When sensitivity is stated in accordance with this basic definition, it is usually given in terms of microamperes per microwatt of radiant flux. The term "radiant flux" includes both visible radiation, or light, and invisible infra-red and ultra-violet radiation. For convenience, sensitivity is frequently stated in terms of visible radiation only. When it is given in this way it is known as "luminous sensitivity" and is usually given in terms of microamperes per lumen of light flux.

The sensitivity of a phototube depends on the color of the light or the spectral distribution of the radiant flux used to excite the tube. For example, the 929 phototube has much higher sensitivity to blue-rich light, such as light from a mercury-vapor lamp, than to blue-deficient light, such as the light of an incandescent lamp. It follows that, when two phototube types are compared on the basis of their sensitivity ratings, the comparison will be valid only if the rated values have been measured with radiations of the same spectral distribution. Also, when two phototube types are being considered for use with a certain light source, if the two types have different color-response curves, a comparison of the sensitivity rating of one type with that of the other may be misleading unless both ratings are for light similar in color to that which is to be used. The sensitivity ratings of Radiotron phototubes are always accompanied by a description of the radiation used when the sensitivity was measured. For many types, sensitivity is measured with radiation provided by a tungsten lamp operated at a filament color temperature of 2870° Kelvin. Exciter lamps used in sound-on-film equipment are generally operated at approximately this temperature.

Gas and High-Vacuum Types

The presence of a small amount of inert gas in a phototube increases the tube's sensitivity, or in other words, the gas increases the amount of current passed by the phototube for a given amount of cathode illumination. Therefore, in the manufacture of several phototube types, a controlled amount of gas is introduced in the tube after evacuation. These gas types have higher sensitivity than the corresponding vacuum types and are generally preferred for some applications, principally those involving sound reproduction. High-vacuum types, on the other hand, have higher internal resistance, more constant sensitivity throughout life, and are less likely to be damaged by accidental operation at higher-than-rated voltage or current. The high-vacuum types are, therefore, preferable for many light-operated relay and light-measurement applications.

The action of gas in increasing the sensitivity of a phototube is briefly as follows: Electrons moving from cathode to anode collide with gas

atoms. In such a collision, the electron may disrupt the atom, knocking an electron out of the atom and leaving a positive ion. This disruption of the atom increases the current through the tube because the new electron is drawn to the anode and the positive ion is drawn to the cathode. The positive ion can further increase current, when it arrives at the cathode, by causing secondary emission from the cathode. Therefore, the presence of gas in the tube increases current in two ways, (1) by the production of ions, and (2) by the increase in cathode emission. The total current in a gas phototube can be several times that of a corresponding high-vacuum type operated with the same light input and anode voltage.

Static and Dynamic Sensitivities of Gas Types

When a phototube is used under steady illumination, its luminous sensitivity can be defined as the quotient of the direct anode current by the incident light flux of constant value. This sensitivity is called the static luminous sensitivity.

When a phototube is used for sound reproduction, the light input to the phototube varies at audio frequency. For this operating condition, the luminous sensitivity of the tube is conveniently defined as the quotient of the amplitude of variation in phototube current by the amplitude of variation in light input. In a gas phototube, this sensitivity, identified as the "dynamic sensitivity," is smaller for a light input varying at high audio frequency than for low frequencies. The reason can be understood from the preceding explanation of how gas increases sensitivity. Because gas ions are relatively large and move relatively slowly, there is a time lag between the disruption of a gas atom and the increase in cathode emission due to the resultant positive ion. Because of this time lag, fluctuations in the emission due to positive ions lag behind fluctuations in the primary photoemission. For high frequencies of light variation, the lag tends to smooth out the variations in the total phototube current and thus, by definition, reduces sensitivity.

The effect is illustrated by the curve below which shows how the sensitivity of Radiotron gas phototubes changes with the frequency of variation in light input. It can be seen that the decrease in sensitivity occurs only at high audio frequencies and that the decrease is small enough so that the tube can reproduce audio signals with good fidelity.

INSTALLATION

General

The socket required by phototubes having a 4-pin base, i.e., the 868, 917, 918, 919, 920, 923, and 928, is of the standard 4-contact type. The cartridge phototubes 921, 922, and 926 employ a clip type of mounting. The 924 employs a standard intermediate screw lamp socket. The 925 and 929 employ a standard octal socket. The 927 employs

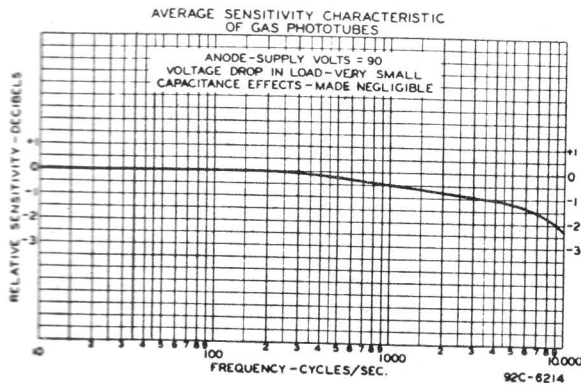

a peewee 3-pin socket. Sockets for all types except the 928 should be mounted so that light is intercepted by the concave surface of the phototube's cathode. The socket for the 928 may be mounted in any suitable position since the cathode of this tube responds to light striking it from any direction.

Shielding of the phototube and its leads to the amplifier or relay valve is recommended when amplifier gain is high or when the phototube load resistance is high. In a circuit employing the 928, when the tube is operated with low impedance between cathode and ground, the cathode shields the anode from stray electrostatic fields. Whenever frequency response is important in a phototube circuit, the leads from the phototube to the amplifier or relay valve should be made short so as to minimize capacitance shunting of the phototube load. Since a phototube is a high-resistance device, it is important that insulation of associated circuit parts and wiring be adequate.

The *maximum ambient-temperature rating* of a phototube should not be exceeded because too high a bulb temperature may cause the volatile cathode surface to evaporate with consequent decrease in the life and sensitivity of the tube.

In *relay or measurement circuits* where the phototube must respond to a very small amount of light, phototube leakage currents should be made small. A low-resistance leakage path between the phototube terminals reduces the effective load resistance and thus decreases the circuit's sensitivity. Also, leakage currents may vary erratically and may mask the effect of the photo-electric current when this current is small. These leakage currents can be reduced by removing dust and grease from insulating surfaces between the phototube terminals with a cloth dampened in alcohol.

In the top-cap types 917 and 919, and the cartridge types 921, 922, and 926, leakage across moisture films on the surface of the glass can be prevented by coating the glass with pure white ceresin wax, or other non-hygroscopic wax. The bulb should be first cleaned, then dipped in the molten wax and held there for a short time so that the heat of the wax will vaporize any moisture from the bulb surface. In the dipping operation the temperature of the wax should not exceed 100°C. It is not necessary to coat the whole bulb. A continuous band of wax, approximately a half-inch wide, around the top-cap or around the bulb is sufficient to interrupt all external leakage paths across the phototube surface.

When an amplifier valve is used in a circuit where extremely low leakage is important, the valve should preferably be a glass type having the grid brought out to a cap at the top of the valve; the bulb of such a valve can be waxed around the top-cap so as to minimize surface leakage. The type 38 is often used in phototube circuits because

it is a power amplifier with a top-cap grid connection.* In a circuit employing one of the cartridge phototubes (921, 922 or 926), when low leakage is important, the phototube terminal which is connected to the amplifier grid-cap should not be in contact with a support than can cause leakage to ground.

Gas Types

If the voltage or current ratings of a gas phototube are exceeded, a gas discharge may occur. This discharge is indicated by a faint blue glow within the tube. Once started, this discharge will continue independently of the illumination on the phototube. When a glow occurs, the anode supply voltage should be disconnected immediately in order to prevent permanent damage to the tube.

The minimum d-c load resistance ratings shown in the CHART are set up for gas phototubes to prevent a blue glow discharge. With the specified values of load resistance, supply voltage, and maximum current, the d-c voltage drop across the load is large enough to protect the tubes. In most relay circuits, the phototube current exceeds 2 microamperes; in usual sound-on-film equipment, the phototube current is less than 2 microamperes.

When the anode-supply voltage for a gas phototube is obtained from an a-c line without rectification, a voltage divider should be connected across the line so that the peak voltage supplied to the tube will never exceed 90 volts. For line voltages of 110 to 125 volts, the voltage divider should provide a phototube supply voltage of not more than half the line voltage. In addition, a series protective resistor, as recommended above, should be included in the phototube circuit.

Gas phototubes 918, 921, and 923 give sensitive operation in relay circuits. However, these three types are primarily designed for applications where the illumination on the phototube is low. These types can be used with large values of illumination but may lose sensitivity in such use. Most of the loss takes place in the first few hours of high illumination with little loss thereafter. The loss can be made small by including in the circuit a large voltage-dropping resistance between the phototube and voltage supply. When a change in sensitivity of the 918, 921, or 923 is not desirable, the light flux on the cathode should not exceed approximately 0.02 lumen.

Exposure to intense illumination, such as direct sunlight, may cause a temporary decrease in the sensitivity of a gas phototube even though no voltage is applied to the tube. The magnitude and duration of this decrease depend on the length of exposure.

In *sound-on-film equipment* employing gas phototubes, the amount of light passing through the slit and film to the phototube is usually so small that there is no danger of a rapid loss of phototube sensitivity so long as the tube is operated within ratings. When film is removed from the camera, the exciter lamp should be switched off so as to prevent excessive illumination of the phototube.

Vacuum Types

For *constant calibration* of high-precision devices using a vacuum phototube, it is essential that the phototube be operated at an anode voltage of not more than about 20 volts. Higher anode voltages may cause ionization of minute traces of residual gas within the tube. The gas current resulting from this ionization may produce slow changes in the tube's characteristics which would change calibration. When a phototube is operated at low anode-supply voltage, the combination of large light input and high phototube load resistance is to be avoided. With this combination, the voltage drop across the load resistance may be so large that the voltage

* Type 6J7-G is an excellent substitute in the Australian range, and has a higher transconductance.—(Editor's Note.)

across the phototube is inadequate. In general, when the anode supply voltage is 20 volts, the d-c voltage drop across the load resistance should not exceed 10 volts.

A further consideration for the maintenance of constant calibration is that the light incident on the phototube should be spread over as large a portion of the cathode surface as possible. This procedure will minimize variations in sensitivity that might be caused by a shift in the position of the light spot on the cathode.

APPLICATION

Circuits for Sound Reproduction

A typical phototube circuit for use in sound reproduction is shown in Fig. 1. The value of phototube load resistance for this circuit depends on the desired signal-output voltage and the permissible distortion. Increasing the phototube load resistance increases signal output but also increases distortion.

A typical circuit for the 920* twin phototube is shown in Fig. 2. In this circuit, the contact on resistor R_2 should be set so as to balance out any difference which may exist between the sensitivities of the two units of the 920. Since the two units of the 920 are mounted in the same gas atmosphere, the ratio of sensitivities of the two units remains approximately constant throughout the life of the tube. Hence, once the circuit is balanced, the 920 tends to maintain balance.

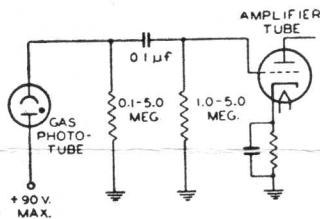
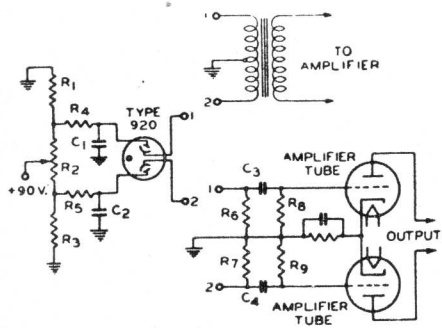

Fig. 1 - Typical circuit for sound reproduction.



$R_1, R_2, R_3, R_4, R_5 = 0.5$ MEGOHM
 $R_6, R_7 = 0.1$ TO 5 MEGOHMS
 $R_8, R_9 = 1$ TO 5 MEGOHMS
 $C_1, C_2, C_3, C_4 = 0.1$ μ f

Fig. 2 - Typical circuit for twin phototube type 920 with either transformer or resistance coupling for sound reproduction.

Circuits for Light-Operated Relays and Light Measurements

Choice of Phototube Type

Circuits for light-operated relays and for light measurements are shown in Figs. 3 to 13. The choice of a phototube type for one of these circuits depends on several factors including the important one of the color of the light source. With respect to color sensitivity, Radiotron phototube types can be divided into three classes. In the first class are types having an S1 or S2 photosurface. These types have high sensitivity in the red and infra-red region of the spectrum. Hence, circuits designed for high red

sensitivity or for operation with infra-red radiation generally employ a phototube of this first class.

In the second class is the type 926 having an S3 photosurface. The spectral sensitivity of this type extends throughout the visible spectrum and peaks in the blue. The relative response of this type to the light reflected from colored objects approximates that of the eye. Hence, circuits used for colorimetry often employ the 926.

In the third class is the type 929 having an S4 photosurface. The sensitivity of this type is very high in the blue-violet and low in the red. For blue-rich light, such as daylight or light from a carbon arc or mercury-vapor lamp, a 929 gives much higher sensitivity than other vacuum types. Although the 929 has low red sensitivity, this type gives better sensitivity than other vacuum types to light from an incandescent lamp operated at a filament color temperature of 2870°K . When the filament of an incandescent lamp is operated at lower temperature, its reduced blue radiation will decrease the sensitivity of the 929.

When a phototube having either an S1 or an S2 surface is preferable, a choice can be made between gas and vacuum types. The presence of gas in a phototube increases the tube's sensitivity but decreases its internal resistance. As a result, in a circuit where it is impracticable to use a phototube load resistance higher than 10 megohms, a gas phototube may give more sensitive operation than a vacuum type; in a circuit where the phototube load resistance can be made larger than 10 megohms, a vacuum phototube may give more sensitive operation.

The sensitivity of a vacuum phototube is more nearly constant throughout tube life than that of a gas type. Also, a vacuum type is less likely to be damaged by accidental application of higher-than-rated anode voltage. Hence, in a circuit where the phototube load resistance can be made high, or where constant calibration or electrical ruggedness is important, a vacuum phototube should be used.

Radiotron 2051 Gas Tetrode in Phototube Circuits

Radiotron 2051 is a gas tetrode especially well suited for use in phototube circuits. The 2051 is a relay tube; a small change in its grid potential can cause its plate current to change from zero to a comparatively large value. The value of grid potential at which plate current starts is called the critical value. Once plate current has started, its magnitude is determined by the anode supply voltage and the impedance in the anode circuit, and is practically independent of control-grid bias for all normal values of bias. In the conducting condition, the tube voltage drop is quite low and is substantially independent of the value of both anode current and control-grid bias.

Phototube relay circuits employing the 2051 are shown in Figs. 3 and 4. In circuits like these, where the 2051 is operated with an a-c anode supply voltage, anode current in the 2051 is zero during negative half-cycles of the a-c voltage on the anode because, during these half-cycles, the anode is negative with respect to cathode. As long as the grid bias is less negative than the critical value, the tube will break down and conduct on positive half-cycles. However, if the grid is made more negative than the critical value, it will prevent conduction on positive half-cycles. In other words, in a-c operation, a change in grid potential can cause a 2051 not only to close a

* For description of push-pull system of sound reproduction for which 920 is designed, see "An Improved System for Noiseless Recording", G. L. Dimmick and H. Belar, Journal of the Society of Motion Picture Engineers, July, 1934.

relay but also to open it. This action is different from that obtained in d-c operation where a change in grid potential can cause the 2051 to close a relay, but normal changes in grid bias cannot cause the relay to open. In d-c operation, the only satisfactory methods for opening the relay, once closed, are to open the anode circuit, or to reduce the 2051 anode supply voltage to a very low value.

One of the advantages of the 2051 for use as a relay tube is its low anode-to-grid capacitance. This capacitance has been made low by inclusion of a shield-grid within the tube. Because this capacitance is low, the tube is insensitive to line-voltage surges. In order that this advantage can be utilized, circuit wiring should be laid out so as to introduce as little external capacitance as possible between the grid and anode.

The RCA-2050 is a gas tetrode similar to the 2051 but having higher voltage and current ratings. Although the 2051 can provide enough current to operate most relays, special magnetic devices handling large power may require one or more 2050's. The 2050 has longer life and more constant characteristics throughout tube life than the 2051. The 2050 is recommended for use in circuits where extremely long tube life and constant calibration are of primary importance. A 2050 can be substituted for the 2051 in the circuits of Figs. 3 and 4 with no change in circuit constants.

Amplifier Tubes in Relay and Measurement Circuits

In many relay and measurement circuits, it is desirable to use a phototube load resistance much higher than 10 megohms. When this resistance is connected between the grid and cathode of an amplifier valve designed for radio use, precautions are necessary because these valves, in general, are rated for operation with not more than 10 megohms d-c resistance between grid and cathode. For power amplifier types, the maximum rated resistance generally is 0.5 megohm.

The reason amplifier valves have a maximum d-c grid-circuit resistance rating is that gas current and grid emission can cause trouble if this resistance is too high. The diagram below illustrates how this trouble arises.

ARROWS INDICATE DIRECTION OF FLOW OF GRID-EMISSION CURRENT AND GAS CURRENT TO GRID

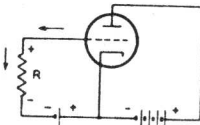

Gas current occurs because there is always a minute amount of residual gas in an amplifier valve. Atoms of this gas are ionized by collision with electrons flowing from cathode to anode. The resultant positive ions are drawn to the negative grid and flow to the source of negative bias voltage through the grid resistor R. The flow of these ions through R builds up a voltage drop across R which makes the grid less negative with respect to cathode. This decrease in negative grid bias increases plate current and thus causes an increase in gas ionization and in gas current to the grid. If the grid-circuit resistance is large enough, the action becomes cumulative and plate current may rise to a large value. Another effect that may contribute to the rise in plate current is emission of electrons from the grid. Positive gas ions bombarding the grid raise its temperature and may cause it to emit electrons. The flow of these electrons through R builds up a voltage drop

across R which reduces the negative grid bias. Thus, when the grid-circuit resistance is very large, gas current and grid emission may cause the plate current to vary erratically over a wide range or to rise to such a large value that the valve is damaged.

In phototube circuits where it is desired to operate an amplifier valve with a very large grid-circuit resistance, gas current can be reduced by operating the valve at low plate and screen voltages and low plate and screen currents. When the voltages across the valve and the currents through the valve are small, there is little gas ionization, and therefore little gas current. Grid emission can be reduced to a very low value by operating the heater at less than rated voltage so that the grid is at a reduced temperature.

From this discussion it can be understood why many relay and measuring circuits use two amplifier valves. The first valve employs a high grid-circuit resistance and is, therefore, operated at low plate current. The second valve usually has to supply enough current to operate a relay and, therefore, must have a comparatively small grid-circuit resistance. The first valve may, or may not, provide voltage amplification of the signal from the phototube. Its primary purpose usually is to act, not necessarily as a voltage amplifier, but as a "buffer" or "resistance transformer." That is, it must transfer the signal from the high-resistance load of the phototube to the comparatively low resistance in the grid circuit of the output valve.

In the circuits of Figs. 5, 6, 7, 9, 10, and 12, the heater of the amplifier valve following the phototube is operated at approximately 4 volts instead of the normal value of 6.3 volts. Because of this large voltage reduction, it may be found that some individual amplifier valves do not give satisfactory operation in these circuits. Hence, these circuits are not well suited for use in equipment which is commercially manufactured and sold in large numbers of units.* The relay circuits of Figs. 3 and 4 are well suited for use in such equipment.

In relay and measurement circuits where the output valve is a pentode or beam power valve, adjustments should be made prior to operation so that the plate current of the output valve will never become large enough to damage the valve or associated relay or meter. In general, the procedure is to set the screen voltage and grid bias of the output valve at zero volts and then increase the screen voltage until the plate current is at the maximum permissible value. The screen voltage is left at this value during use of the circuit. In most circuits, the grid can never become appreciably more positive than zero bias during normal operation; hence, the adjustment insures that, during normal operation, the plate current will not exceed the permissible value. When the adjustment is made, consideration should be given to the fact that, during use of the circuit, line voltage may swing higher than its value at the time the adjustment is made. Until the adjustment of screen voltage has been made, the screen voltage should be kept at a low value.

Circuit Precaution

In the circuits of Figs. 3, 4, 5, 9, 10, and 12, circuits which are connected directly to the a-c

* All Australian-made Radiotron valves other than power valves may be used with a d-c grid circuit resistance up to 10 megohms with normal heater voltage, provided that the plate current does not exceed 1 mA. The Australian-made Radiotron 6J7-G or 6C6 may be used with high grid circuit resistances provided that the heater voltage is reduced. Reduction down to a heater voltage of 4.5 volts may be generally made without any difficulty, but for lower voltages it may be necessary to select individual valves. In the case of other types it is generally necessary to select individual valves for any reduction of heater voltage.—(Editor's Note.)

line, a double-pole on-off switch is shown. This switch makes it simple to disconnect the circuit from both sides of the line when repairs or adjustments are to be made, and thus reduces the danger of shock.

Relay Circuit, Fig. 3

A relay circuit in which the relay is energized by an increase in light is shown in Fig. 3. In this circuit, positive voltage is supplied to the 2051 anode and the phototube anode during every other half-cycle of line voltage, when the upper side of the a-c line is positive. During these half-cycles, negative bias voltage is supplied to the 2051 grid from R_3 . The potential of the grid is made less negative by the 1R drop across R_4 resulting from the flow of phototube current through R_4 . In the use of this circuit, the contact on R_3 is adjusted so that, as long as the illumination on the phototube is less than a certain value, the 2051 grid potential is sufficiently negative to prevent conduction of plate current. When the illumination rises above this value, the 1R drop across R_4 reduces the negative grid potential, the 2051 conducts, and the relay closes. The resistance of R_3 is high enough to keep the current through the 2051 within the tube's maximum rating.

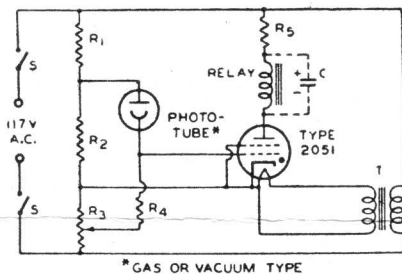

$C = 2-8 \mu\text{f}$, 250 V. USED IF NEEDED TO PREVENT RELAY CHATTER
 R_1, R_2 FOR VACUUM-TYPE PHOTOTUBE: $R_1 = 0$ OHMS
 $R_2 = 20000$ OHMS, 1 WATT
 FOR GAS-TYPE PHOTOTUBE: $R_1 = 10000$ OHMS, 1/2 WATT
 $R_2 = 9000$ OHMS, 1/2 WATT
 $R_3 = 1000$ OHMS, 1 WATT
 $R_4 = 1-10$ MEGOHMS
 $R_5 =$ CURRENT-LIMITING RESISTOR, SEE TEXT
 $S =$ DOUBLE-POLE ON-OFF SWITCH
 $T =$ HEATER TRANSFORMER, 6.3 V., 0.6 AMP.
 RELAY SHOULD OPERATE ON 25 MA. OR LESS

Fig. 3 - Relay circuit employing type 2051. Relay energized by increase in light.

The function of R_5 in this circuit is to keep the relay current within the relay's maximum rating. To determine the proper value of this resistance, set the contact on R_3 so that the relay stays closed, and adjust R_5 to a value such that the relay current is within the relay's maximum rating. In many relays, the resistance of the relay itself is sufficient to hold the current to a safe value. With such a relay, R_5 can be omitted.

Relay Circuit, Fig. 4

A relay circuit in which the relay is energized by a decrease in light is shown in Fig. 4. The operation of this circuit is similar to that of Fig. 3, the difference being that in Fig. 4, a decrease in phototube current makes the 2051 grid less negative. The relay closes, therefore, whenever illumination drops below a certain value. This value can be controlled by adjustment of the contact on R_2 .

When a gas-type phototube is used in this circuit, the current through the 2051 should be limited to a value such that the 1R drop across R_4 cannot cause the peak voltage on the phototube

to exceed 90 volts. Sufficient limitation is provided by making the total resistance of R_5 and the relay not less than 1500 ohms. When the phototube is a vacuum type, the function of R_5 is the same as that of R_5 in Fig. 3.

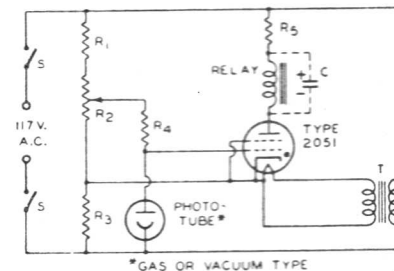

$C = 2-8 \mu\text{f}$, 250 V. USED IF NEEDED TO PREVENT RELAY CHATTER
 R_1, R_2 FOR VACUUM-TYPE PHOTOTUBE: $R_1 = 0$ OHMS
 $R_2 = 5000$ OHMS, 4 WATTS
 FOR GAS-TYPE PHOTOTUBE: $R_1 = 3000$ OHMS, 2 WATTS
 $R_2 = 2000$ OHMS, 1 WATT
 $R_3 = 1000$ OHMS, 1 WATT
 $R_4 = 1-10$ MEGOHMS
 $R_5 =$ CURRENT-LIMITING RESISTOR, SEE TEXT
 $S =$ DOUBLE-POLE ON-OFF SWITCH
 $T =$ HEATER TRANSFORMER 6.3 V., 0.6 AMP.
 RELAY SHOULD OPERATE ON 25 MA. OR LESS

Fig. 4 - Relay circuit employing type 2051. Relay energized by decrease in light.

Relay and Measurement Circuit,

Fig. 5

A circuit which can provide faster response than the circuits of Figs. 3 and 4 is shown in Fig. 5. Because the circuits of Figs. 3 and 4 operate on a.c. without rectification, the relay in these circuits must be sluggish enough so that the 60-cycle variations in line voltage will not make the relay chatter. Also, the phototube in Figs. 3 and 4 is in operation only during alternate half-cycles of line voltage when the upper side of the a-c line is positive. As a result, the circuits of Figs. 3 and 4 do not give good response to a change in light whose duration is on the order of one-sixtieth of a second or less. The circuit of Fig. 5, which includes a rectified d-c power supply, can respond to changes shorter than a sixtieth of a second.

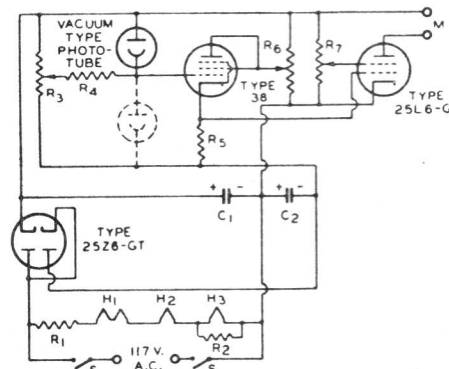

$C_1, C_2 = 8 \mu\text{f}$, 250 V.
 $H_1 = 2526$ -GT HEATER
 $H_2 = 25L6$ -GT HEATER
 $H_3 = 38$ HEATER
 $M_3 =$ D-C MILLIAMMETER OR RELAY (0-25 MA.)
 $R_1 = 2000$ OHMS, 20 WATTS
 $R_2 = 50$ OHMS, 1-WATT
 $R_3 = 1$ MEGOHM
 $R_4 = 100$ MEGOHMS
 $R_5 = 0.5$ MEGOHM
 $R_6, R_7 = 0.1$ MEGOHM
 $S =$ DOUBLE-POLE ON-OFF SWITCH

Fig. 5 - Fast-acting circuit for relay or measurement operations.

A further difference between the 2051 circuits and the circuit of Fig. 5 is that the 2051 plate current changes abruptly from one value to another when phototube illumination rises above a certain value. In Fig. 5, the 25L6-GT plate current changes continuously with change in phototube illumination. The circuit of Fig. 5 is, therefore, suitable for use not only as a relay circuit but also for illumination measurements.

When the phototube is connected as shown in solid lines in Fig. 5, an increase in phototube illumination causes an increase in the plate current of the 25L6-GT. When the connections are as shown in dotted lines, an increase in illumination causes a decrease in output current.

When the circuit is to be connected as shown in solid lines, the procedure for adjusting it to give best operation is as follows: Set the contacts on R_3 and R_4 at the positive end of their ranges, and adjust the 25L6-GT screen voltage by means of R_1 so that the plate current of the 25L6-GT has the desired value of maximum output current. If the circuit is to operate a relay, this current should be slightly larger than the value which closes the relay. Next, move the contact on R_3 toward the negative end of R_3 until the 1R drop across R_3 has the value such that the grid of the 25L6-GT is slightly negative with respect to the 25L6-GT cathode. The correct setting of R_3 can be determined by measurement of the 25L6-GT plate current. When the movement of the contact on R_3 starts to affect this plate current, the 25L6-GT grid has a small negative bias, and R_4 is correctly adjusted. Next, set the phototube illumination at the value at which the relay is to close, or at the largest value to be measured, and move the contact on R_3 toward the negative end of R_3 until the movement of the contact starts to affect the plate current of the 25L6-GT. The circuit is then ready for operation. A small decrease in phototube illumination will produce a comparatively large decrease in output current.

When the phototube is to be connected as shown in dotted lines, the adjustment procedure is the same except that during the adjustment of R_3 and R_4 , the phototube illumination should have the value at which the relay is to open or the smallest value to be measured. After the adjustments have been made, a small increase in illumination will produce a comparatively large decrease in output current.

In adjustment of the circuit with solid-line connections, if the phototube illumination during adjustment of R_3 is large, it may be found that moving the contact on R_3 all the way to the negative end of R_3 does not affect the 25L6-GT plate current. This finding indicates that the sensitivity of the circuit is too high for the amount of light being used. The light on the phototube cathode should be reduced, or else the circuit sensitivity should be reduced by reducing the resistance of R_4 . Similarly, in adjustment of the circuit with dotted-line connections, if the phototube illumination used during adjustment of R_3 and R_4 is so large that the 25L6-GT plate current is much smaller than 25 milliamperes, the phototube illumination or the circuit sensitivity should be reduced.

Battery-Operated Relay and Measurement Circuit, Fig. 6

A battery-operated circuit for relay and measurement purposes is shown in Fig. 6. Because the current drawn from the 45-volt and 22½-volt batteries is low, the use of small batteries of the C-battery type for B_2 and B_3 will give long life. The 6K6-GT* requires a comparatively large plate current in order to operate a relay and is, there-

fore, supplied from a storage battery and vibrator-transformer. The vibrator and transformer can be of the type used in automobile radio receivers. Heater voltages can, of course, be obtained from the storage battery.

When the phototube is connected as shown in solid lines, the plate current of the 6K6-GT increases when phototube illumination increases. In the dotted-line connection, output current increases when illumination decreases.

A simple procedure for adjusting this circuit is as follows: Set the contact on R_3 at the lower end of R_3 and set the grid bias of the 6K6-GT at zero by short-circuiting R_4 . Move the contact on R_3 until the 6K6-GT plate current has the desired maximum value. The contact should never be moved so high that plate current exceeds 30 milliamperes; a plate current higher than 30 milliamperes may cause the maximum plate-dissipation rating of the 6K6-GT to be exceeded. After R_3 is adjusted, the short-circuit connection across R_4 should be removed and R_4 should be adjusted so that the circuit gives best operation over the range of illumination values to be encountered in use of the circuit.

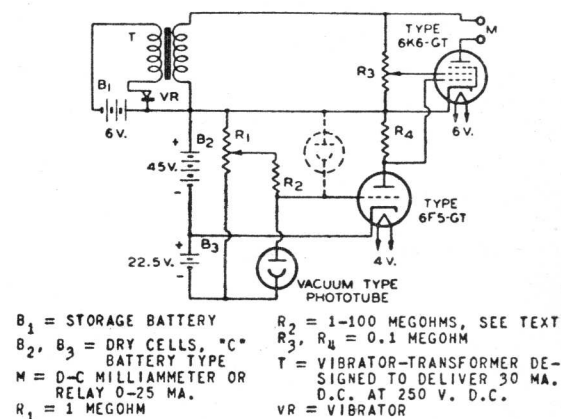

Fig. 6 - Battery-operated circuit for relay or measurement operations.

If the maximum illumination of interest is very low, highest sensitivity will be obtained by use of a high value of resistance for R_2 . However, if the circuit is to respond to changes in a large value of illumination, it may be advisable to use a lower value for R_2 between 1 and 10 megohms. The reason is that the supply voltage for the phototube is low. If illumination is large and if R_2 is large, the voltage drop across R_2 may be so large that the voltage across the phototube is inadequate.

Matching Circuit, Fig. 7

Matching measurements of photometric qualities such as candlepower, color, and turbidity can be made with high precision by means of the circuit shown in Fig. 7. This circuit can be used, for example, to determine whether the candlepower of a lamp is precisely equal to that of a standard lamp. For this use, the circuit is first adjusted so that the microammeter reads mid-scale when one phototube is exposed to light from the standard lamp and the other phototube is exposed to light from a comparison lamp. The standard lamp is then replaced by the unknown lamp. If the unknown lamp supplies exactly the same amount of light to the first phototube that the standard lamp did, the meter reading will be the same as for

*The Australian-made 6F6-G or 6V6-G may be used without any circuit change.—(Editor's Note.)

the standard lamp. However, if there is a difference, even though very small, between the amounts of light supplied by the standard lamp and the unknown lamp, the bias applied to the 38 will be different and the meter reading, therefore, will change. Thus, the circuit can be used to detect a very small mismatch between the lamps. By exposing the phototubes to light reflected from materials or transmitted by liquids, the circuit can also be used to match or measure color, turbidity, and other photometric qualities.

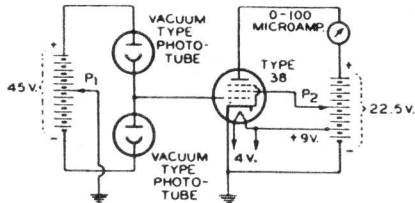

Fig. 7 - Sensitive circuit for matching measurements.

The action of this circuit can be best understood by considering one phototube as the load for the other. In Fig. 8, Curve I is the current-voltage characteristic of one phototube; Curve II is the current-voltage characteristic of the other tube drawn as a load line on Curve I. The intersection of the two curves gives the distribution of voltage across the phototubes because the phototubes, being in series, must pass the same current. When the circuit is so adjusted that the intersection is on the flat portion of the curves, a small change in the illumination on one phototube produces a large shift of the point of intersection. This is shown by the dashed-line curve which represents the current-voltage characteristic for one phototube under slightly decreased illumination. The wide shift in the intersection means a large change in the bias on the grid of the 38. Consequently, the circuit has high sensitivity.

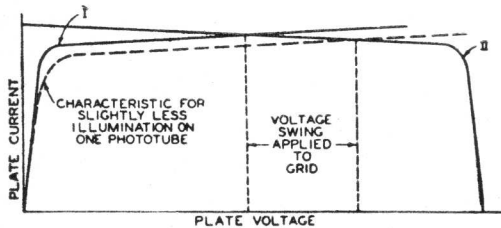

Fig. 8

The circuit can be adjusted for operation as follows: Short circuit the grid to the cathode of the 38 and adjust contact P₂ so that the microammeter deflection is slightly less than full scale. This adjustment assures that, during the operation of the circuit, the plate current of the 38 will not exceed the meter's full-scale value. Then remove the shorting connection from the grid and, with zero illumination on the phototubes, adjust P₁ so that the microammeter deflection is approximately mid-scale. Next set the illumination on one phototube at a convenient value and adjust the illumination on the other phototube so that the meter deflection is again mid-scale. The circuit is then ready for operation. This adjustment procedure compensates for differences in the insulation resistance and sensitivity of individual phototubes.

For high sensitivity, it is important that grid current in the 38 be small. Emission current from the heater to the grid can be minimized by

a positive bias of 9 volts applied to the heater, as indicated in Fig. 7. Leakage current to the grid can be made small by means of the precautions described in the fourth, fifth, and sixth paragraphs under INSTALLATION. The response of the meter to a change in illumination may be slow, especially at low light levels. The reason is that the dynamic resistance between the grid and the cathode of the 38 may be so large that this resistance, when multiplied by the input capacitance of the 38, gives a large time constant.

A-C Operated Circuit for Matching Measurements, Fig. 9

An a-c operated circuit for matching measurements is shown in Fig. 9. This circuit employs two phototubes and a 38 connected in the high-sensitivity arrangement of Fig. 7, but requires no battery or microammeter. Anode voltage is supplied to the phototubes by the 6H6 connected as a voltage-doubler rectifier. Positive plate and screen voltages are supplied to the 38 and 6E5 on every other half-cycle of the a-c line voltage.

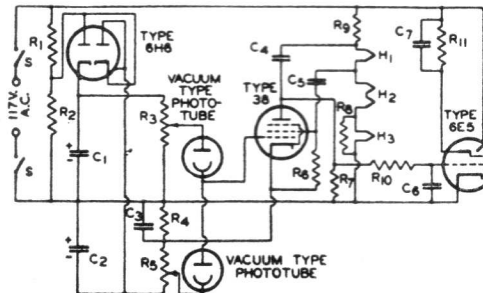

H ₁ = 6E5 HEATER	R ₈ = 50,000 OHMS, 1/2 WATT
H ₂ = 6H6 HEATER	R ₆ , R ₇ , R ₁₁ = 2 MEGOHMS, 1/2 WATT
H ₃ = 38 HEATER	R ₈ = 50 OHMS, 1/2 WATT
C ₁ , C ₂ , C ₃ = 4 μf, 250 V.	C ₄ , C ₅ , C ₆ , C ₇ = 0.1 μf, 200 V.
R ₁ = 15,000 OHMS, 1/2 WATT	R ₉ = 320 OHMS, 30 WATTS
R ₂ = 100,000 OHMS, 1/2 WATT	R ₁₀ = 0.5 MEGOHM, 1/2 WATT
R ₃ , R ₅ = 1 MEGOHM, 1/2 WATT	S = DOUBLE-POLE ON-OFF SWITCH

Fig. 9 - A-C operated sensitive circuit for matching measurements.

The magnitude of the plate current of the 38 is indicated by the 6E5. The applications for this circuit are the same as those for the circuit of Fig. 7. The procedure for adjusting the circuit is similar to that for the circuit of Fig. 7. First, with zero illumination on the phototubes, set potentiometer R₃ at about the middle of its range and adjust R₄ so that the shadow angle of the 6E5 is half closed. Then apply a convenient value of illumination to one phototube and adjust the illumination on the other phototube so that the 6E5 shadow angle is again half closed. The circuit is then ready for operation. For illumination levels as low as 0.0001 lumen, an unbalance of 1/4 of 1 per cent. in the light on the phototubes will cause the 6E5 shadow angle to open to 90° or close to 0°. This sensitive response is obtained only when leakage currents are made small as described in the fourth, fifth, and sixth paragraphs under INSTALLATION. At higher illumination levels, the 6E5 shadow angle gives full response to an even smaller percentage unbalance because the ratio of photo-electric current to leakage currents is larger.

Circuit for Measurement of Light-Intensity Ratios, Fig. 10

Ratios of light intensities can be measured by means of the circuit of Fig. 10. Within the

operating range of this circuit, the reading it provides is not affected by variation in the absolute magnitudes of the light inputs to the two phototubes as long as the ratio between the light inputs remains constant. The applications of this circuit are similar to those of the circuit of Fig. 9. The circuit of Fig. 9 has the advantage that it can detect an extremely small inequality between two light sources. The circuit of Fig. 10 has the advantage that it can measure directly the ratio between the intensities of two sources.

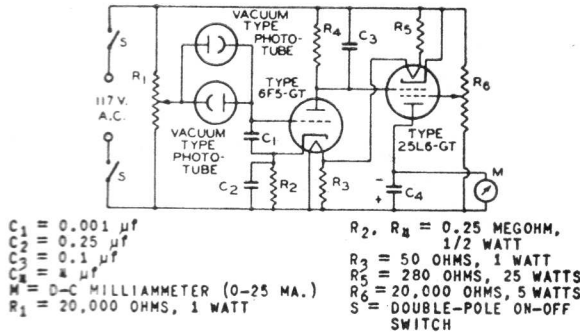

Fig. 10 - Circuit for measurement of light-intensity ratios.

The operation of this circuit is illustrated by the curves of Fig. 11. Condenser C_1 is charged by the a-c line through the two phototubes. On one half-cycle of line voltage, the line charges C_1 through one phototube; on the next half-cycle, the line charges the condenser in the opposite direction through the other phototube. If the two phototubes have equal sensitivities and equal illuminations, the opposite charging effects of the two phototubes are equal, as indicated in Figs. 11a and 11b. Under this condition, the 6F5-GT* grid is at the same d-c potential as the lower side of the a-c line. If the light on phototube No. 1 is suddenly doubled, the d-c voltage across condenser C_1 changes because C_1 receives more charge from phototube No. 1 than from No. 2. The d-c voltage built up across C_1 reduces the time during which phototube No. 1 conducts current because the tube conducts only, of course, when its anode is positive with respect to its cathode. The condenser will finally charge up to an equilibrium voltage at which the conducting time of No. 1 is reduced enough so that the charge supplied to C_1 by No. 1 is equal to that supplied by No. 2, as indicated in Figs. 11d and 11e. This equilibrium voltage is determined by the ratio of the illuminations on the phototubes. For example, with twice as much illumination on No. 1 as on No. 2, the equilibrium voltage must be such that No. 2 conducts during approximately twice as much time as No. 1. The voltage across C_1 is amplified by the 6F5-GT and controls the plate current of the 25L6-GT. The meter in the plate circuit of the 25L6-GT can be calibrated to show directly the illumination on one phototube as a multiple or fraction of that on the other.

The adjustment procedure for this circuit is as follows: Set the contact on R_6 at the upper end of R_6 , so that the screen of the 25L6-GT is at zero volts with respect to its cathode, and set the grid bias of the 25L6-GT at zero by short-circuiting R_4 . Increase the screen voltage of the 25L6-GT by means of R_6 until the plate current brings the meter M to full scale. Remove the shorting connection from R_4 and adjust R_1 so that the circuit

* The Australian-made Radiotron 6B6-G may be used as a substitute, the diodes being connected to the cathode.—(Editor's Note.)

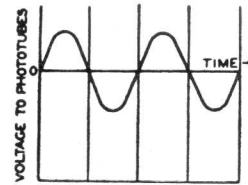

Fig. 11a - Equal illuminations on phototubes.

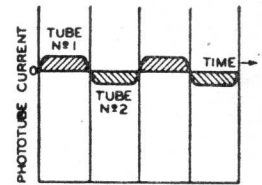

Fig. 11b - Equal illuminations on phototubes. Shaded areas = current \times time = charge. Algebraic sum of areas = zero.

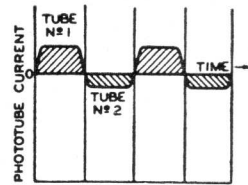

Fig. 11c - Light on No. 1 doubled. Shaded areas no longer add to zero.

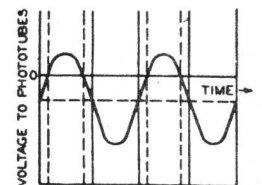

Fig. 11d - Light on No. 1 twice that on No. 2. C_1 charges up, shifting zero line, and reducing conduction time of No. 1.

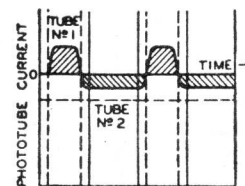

Fig. 11e - Equilibrium condition attained by circuit with twice as much light on No. 1 as on No. 2. Conduction time of No. 1 is reduced sufficiently so that shaded areas add to zero.

operates best over the range of illumination ratios to be encountered in use of the circuit. The value shown for C_1 in Fig. 10 is for use with small values of light input. For larger values of light input, this capacitance should be made larger. The only undesirable effect of increasing this capacitance is that the circuit is made more sluggish in its response to changes in the ratio of light inputs.

Exposure-Control Circuit, Fig. 12

A circuit for automatically controlling photographic exposure time is shown in Fig. 12. This circuit is used in making photographic enlargements, photostats, microphotographs, etc. In use of the circuit, the phototube receives light reflected or transmitted from the film being exposed. The circuit measures the product of the intensity and duration of the illumination on the phototube and thus measures the exposure of the film. When the exposure has reached the desired value, the circuit automatically opens a relay which removes light from the film.

The circuit measures exposure by measuring the change in voltage across a condenser in series with the phototube. This voltage change is proportional to the charge supplied by the phototube. The charge is equal to the time integral of the current flowing into the condenser through the phototube. Since the phototube current is proportional to the light coming to the phototube from the film, the change in voltage across the condenser is proportional to the exposure of the film.

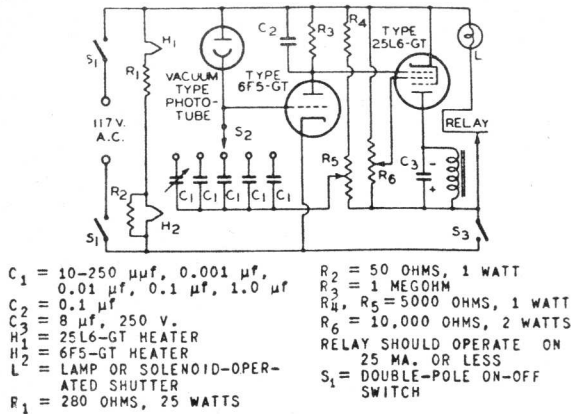

Fig. 12 - Photographic-exposure control circuit.

In operation of the circuit, switch S_3 is first opened. Opening this switch applies full line voltage to the 6F5-GT grid through R_4 , R_6 , C_1 and S_2 . Current flows from the grid to the cathode on positive half-cycles of the a-c voltage until condenser C_1 is charged to a voltage approximately equal to the peak line voltage. This charging process takes only a fraction of a second. Switch S_3 is then closed. Closing the switch returns the positive side of C_1 to the 6F5-GT cathode and thus applies the d-c voltage across C_1 as negative bias to the 6F5-GT grid. This negative bias cuts off plate current in the 6F5-GT and reduces the voltage drop across R_3 , the bias voltage for the 25L6-GT grid, to zero. Closing switch S_3 also applies plate and screen voltage to the 25L6-GT. With plate and screen voltage on the 25L6-GT and with zero bias on its grid, the relay closes and exposure of the film and phototube starts. The phototube feeds positive charge into condenser C_1 and thus reduces the negative charge built up in the condenser during the time S_3 was open. As C_1 is discharged by the phototube, the 6F5-GT grid becomes less negative and plate current starts to flow in the 6F5-GT. The flow of this current through R_3 produces a voltage drop across R_3 which makes the grid of the 25L6-GT negative with respect to its cathode and reduces the plate current through the relay. When C_1 is discharged by the phototube sufficiently, the relay current is reduced to the value at which the relay opens. In this way, the circuit cuts off the light on the film when exposure has reached the desired value.

The procedure for adjusting this circuit is to set the contact on R_6 at the upper end of R_6 , so that the voltage on the screen of the 25L6-GT is zero with respect to its cathode, and to connect the grid of the 25L6-GT to its cathode instead of to the 6F5-GT plate. Increase the 25L6-GT screen voltage by means of R_6 until the relay current is a little larger than the value required to close the relay. Re-connect the 25L6-GT grid to the 6F5-GT plate and the circuit is ready for operation. For control of exposure time, switch S_2 can be used as a coarse control and R_6 , as a fine control.

Circuit for Measurement of Very Small Values of Illumination, Fig. 13

A circuit for measurement of very small values of illumination is shown in Fig. 13. This circuit can measure illuminations corresponding to a phototube current of only 10^{-10} ampere. The bridge arrangement of the circuit makes the zero setting practically independent of supply-voltage variations. The use of a voltage-regulated screen supply makes the

sensitivity of the circuit very little affected by supply-voltage variations. Because the drain on the 22½-volt battery is only a fraction of a microampere, a small C battery will give good life.

The procedure for adjusting the circuit is to switch the microammeter to its 0-1000 microamperes scale, reduce the phototube illumination to zero, and bring the meter reading to zero by adjustment of R_7 , as a coarse control and R_1 , as a fine control. The circuit is then ready for operation. Because the variation of meter current with illumination is practically linear, the circuit can be calibrated at comparatively large values of illumination and the calibration can be extended to small illumination values. It is, of course, especially important in this circuit that phototube leakage currents be made small as described under INSTALLATION.

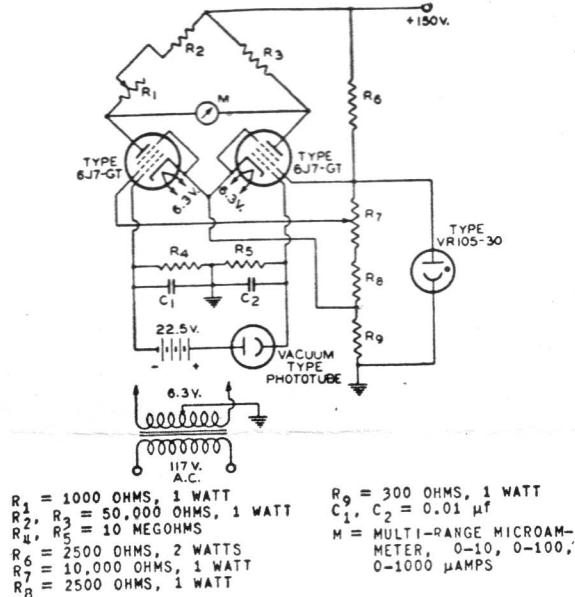

Fig. 13 - Circuit for measurement of very small values of illumination.

The license extended to the purchaser of tubes appears in the License Notice accompanying them. Information contained herein is furnished without assuming any obligations.

EDITOR'S NOTE.

Advice regarding the applications of Radiotron phototubes will gladly be given on request by the Unified Sales-Engineering Service, Box 2516 BB, G.P.O., Sydney. It is hoped that from time to time, as circumstances permit, further circuits illustrating the applications of phototubes will appear in *Radiotronics*. Circuit diagrams for particular requirements will be supplied on request.

PHOTOTUBE REFERENCES

- Campbell and Ritchie. *Photoelectric Cells*. Sir Isaac Pitman and Sons, Ltd. Gulliksen and Vedder. *Industrial Electronics*. John Wiley and Sons, Inc. Henney, Keith. *Electron Tubes in Industry*. McGraw-Hill Book Co., Inc. Hughes and DuBridge. *Photoelectric Phenomena*. McGraw-Hill Book Co., Inc. Shepard, F. H. Jr. *Application of Conventional Vacuum Tubes in Unconventional Circuits*. Proc. I.R.E., Dec., 1936. Shepard, F. H. Jr. *Some Unconventional Vacuum Tube Applications*. RCA Review, Oct., 1937. Zworykin and Wilson. *Photocells and Their Applications*. John Wiley and Sons, Inc.

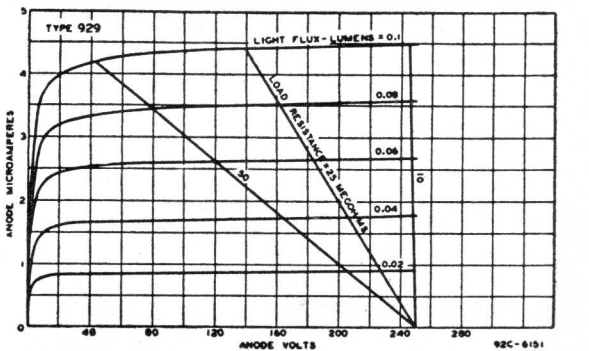
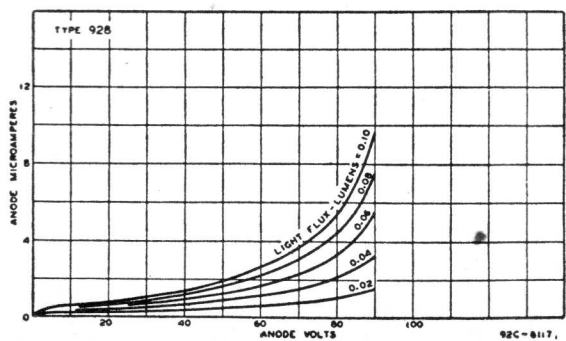
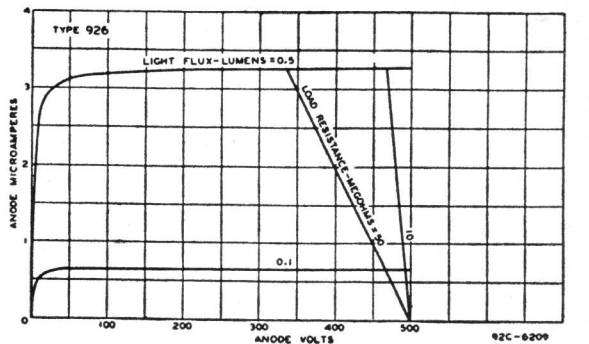
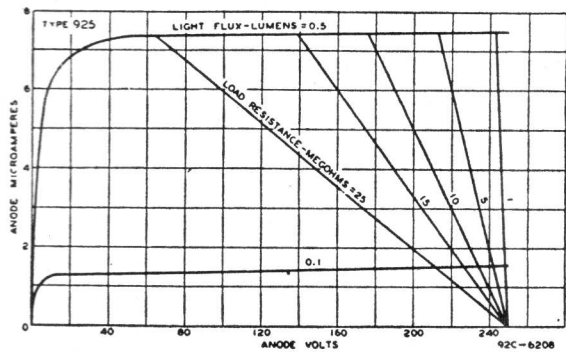
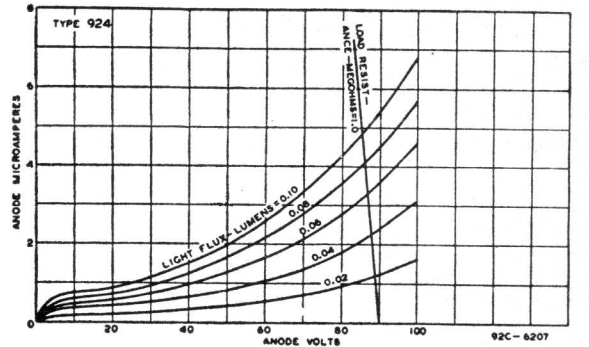
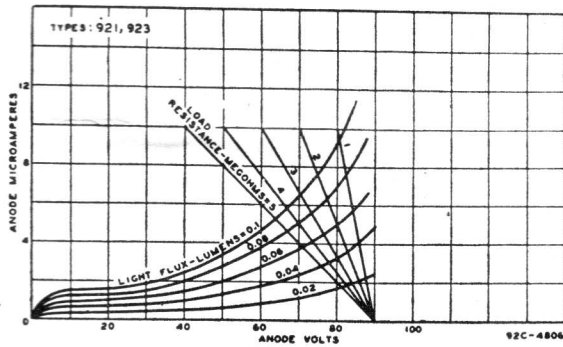
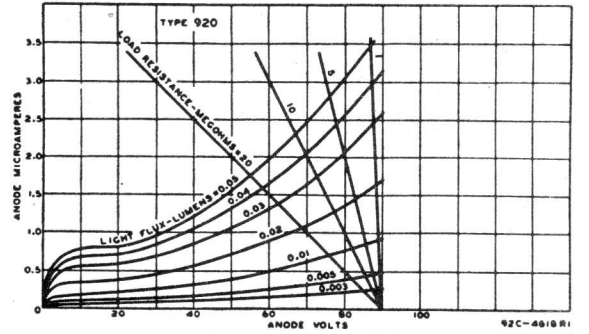
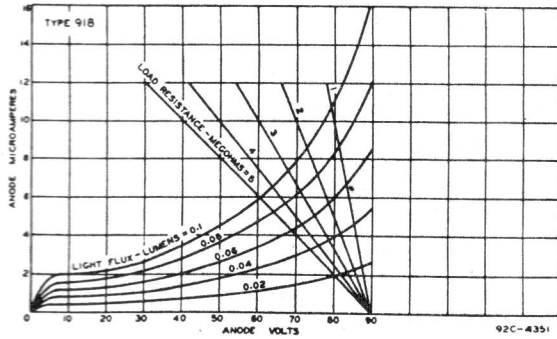
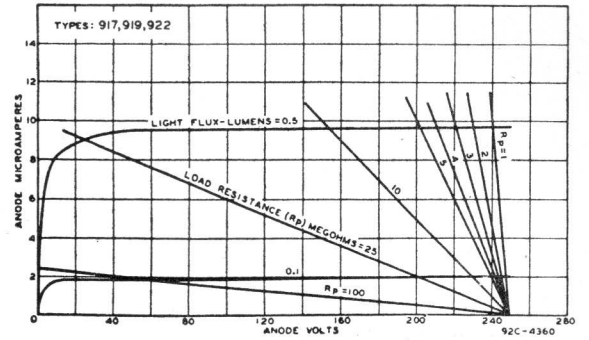
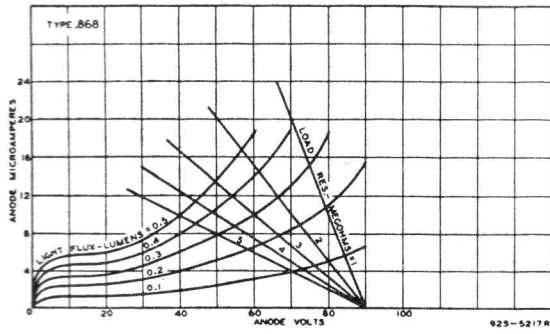

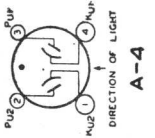

A-4

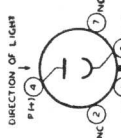

A-5

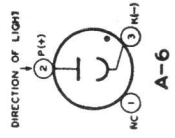

A-6

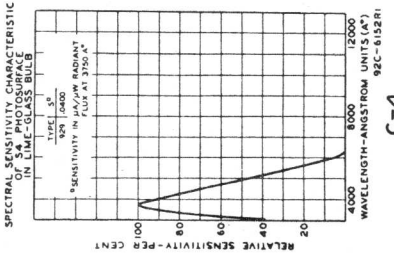

C-4

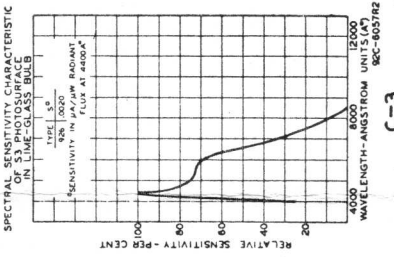

C-3

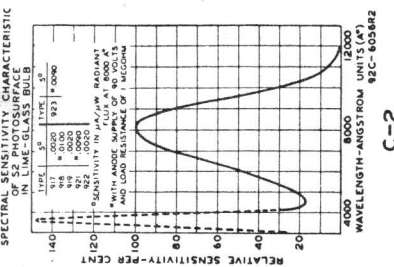

C-2

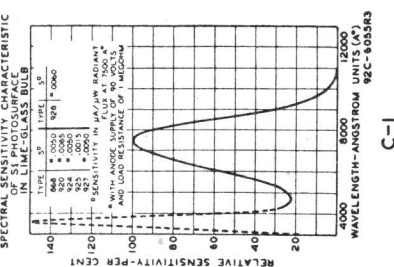

C-1

K = CATHODE
 NC = NO CONNECTION
 P = ANODE
 ● = GAS TYPE

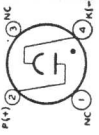

A-7

BOTTOM VIEWS OF SOCKET CONNECTIONS ARE SHOWN

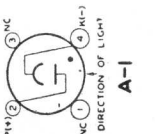

A-1

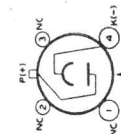

A-2

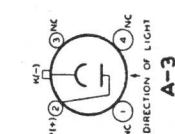

A-3

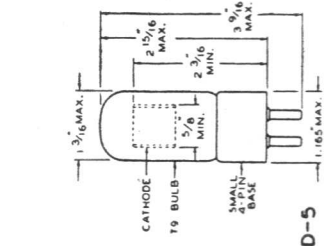

D-5

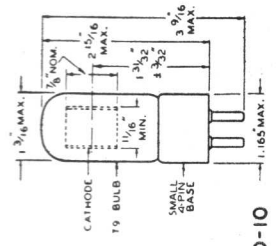

D-10

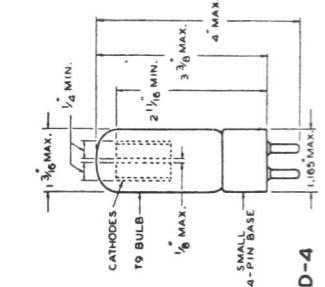

D-4

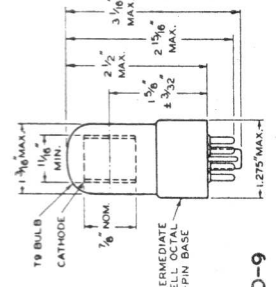

D-9

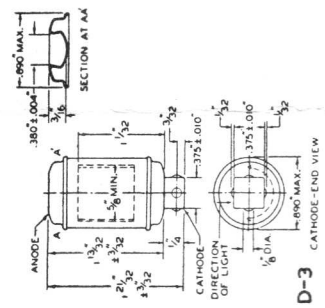

D-3

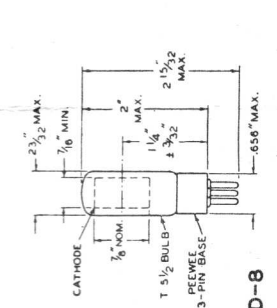

D-8

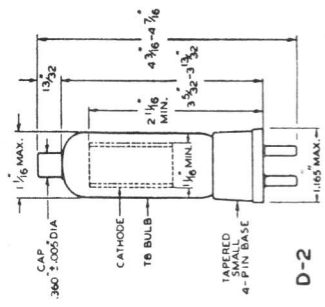

D-2

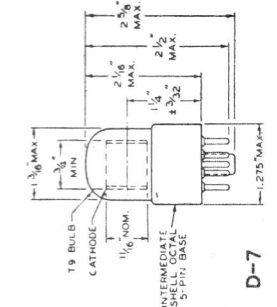

D-7

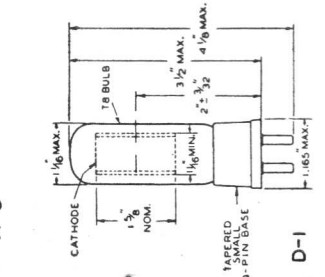

D-1

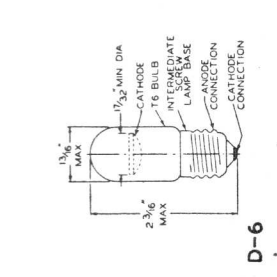

D-6

TYPE	NAME	PRINCIPAL USE	DIMENSIONS & SOCKET CONNECTIONS		CATHODE		LUMINOUS SENSITIVITY			SPEC-TRAL SENSITIVITY CURVE	GAS AMPLIFICATION FACTOR ^a	DIRECT INTER-ELECTRODE CAPACITANCE μf	MAX. AMBIENT TEMPERATURE $^{\circ}\text{C}$	MAX. ANODE SUPPLY D-C OR PEAK A-C VOLTS	MAX. ANODE CUR-RENT * $\mu\text{AMP.}$	MIN. D-C LOAD RESISTANCE (MEGOHMS) FOR				TYPE		
			DIMEN. S.C.	SOCKET	PHOTO-SURFACE	WINDOW AREA	CYCLES	CYCLES	CYCLES							CYCLES	UP TO 75-V SUPPLY	90-V SUPPLY			500-V SUPPLY	
																		BELOW 3.5 $\mu\text{AMP.}$	ABOVE 3.5 $\mu\text{AMP.}$			BELOW 2 $\mu\text{AMP.}$
868	GAS PHOTOTUBE	Sound Reproduction	D-1	A-1	S1	1.0	65	61	57	C-1	Not over 7	2.4	100	90	20	0	0.1	0.1	2.5	-	-	868
917	VACUUM PHOTOTUBE with Anode Cap	Relays and Measurements	D-2	A-2	S2	0.9	20	20	20	C-2	-	2.0	100	500	30	-	-	-	-	1	10	917
918	GAS PHOTOTUBE	Sound Reproduction	D-1	A-1	S2	1.0	110	104	96	C-2	Not over 10	2.4	100	90	20	0	0.1	1	4	-	-	918
919	VACUUM PHOTOTUBE with Cathode Cap	Relays and Measurements	D-2	A-3	S2	0.9	20	20	20	C-2	-	2.0	100	500	30	-	-	-	-	1	10	919
920	TWIN PHOTOTUBE (Gas Type)	Sound Reproduction	D-4	A-4	S1	0.3	75	70	65	C-1	Not over 10	1.5#	100	90	10	0	0.1	1	4	-	-	920
921	GAS PHOTOTUBE (Cartridge Type)	Sound Reproduction	D-3	-	S2	0.4	100	94	87	C-2	Not over 10	1.1	100	90	20	0	0.1	1	4	-	-	921
922	VACUUM PHOTOTUBE (Cartridge Type)	Relays and Measurements	D-3	-	S2	0.4	20	20	20	C-2	-	0.6	100	500	30	-	-	-	-	1	10	922
923	GAS PHOTOTUBE	Sound Reproduction	D-5	A-1	S2	0.4	100	94	87	C-2	Not over 10	2.1	100	90	20	0	0.1	1	4	-	-	923
924	GAS PHOTOTUBE (End Type)	Relays	D-6	-	S1	0.2	55	Less than 55	Less than 55	C-1	Not over 8.5	2.6	100	90	15	0	0.1	0.1	2.5	-	-	924
925	VACUUM PHOTOTUBE	Relays	D-7	A-5	S1	0.4	15	15	15	C-1	-	1.0	100	250	20	-	-	-	-	1	-	925
926	VACUUM PHOTOTUBE (Cartridge Type)	Colorimetry	D-3	-	S3	0.4	6.5	6.5	6.5	C-3	-	0.6	100	500	20	-	-	-	-	1	10	926
927	GAS PHOTOTUBE	Sound Reproduction	D-8	A-6	S1	0.4	75	70	65	C-1	Not over 7	2.0	100	90	2	0	-	0.1	-	-	-	927
928	PHOTOTUBE (Non-Directional Type)	Relays	D-10	A-7	S1	0.7	65	Less than 65	Less than 65	C-1	Not over 10	2.8	100	90	15	0	0.1	1	4	-	-	928
929	VACUUM PHOTOTUBE	Relays and Measurements	D-9	A-5	S4	0.6	45	45	45	C-4	-	2.5	50	250	20	-	-	-	-	1	-	929

^a These sensitivity values are measured with a light input varied sinusoidally about a mean value from zero to a maximum of twice the mean. The sensitivity values shown are the ratio of the amplitude of variation in the current output to the amplitude of variation in the light input as measured by a photometer operating at a filament color temperature of 2870°K. Sensitivity of the vacuum phototubes is measured with a 1-megohm load, and a mean light input of 0.015 lumen. Sensitivity of the vacuum phototubes was measured with a 250-volt supply, a 1-megohm load, and a mean light input of 0.1 lumen.

* Ratio of sensitivity at maximum anode voltage to sensitivity at a voltage sufficiently low (approximately 35 volts) to eliminate gas ionization effects.

• On basis of the use of a sensitive cathode area 1/2" in diameter.

□ Values are for each unit.

Between cathode and anode of each unit. Capacitance between cathodes = 1.6 μf ; between anodes = 0.35 μf .

RADIOTRON NEWS

Radiotron 8S4 is a 1.4-2.8 volt power pentode of the miniature type which has essentially the same characteristics as the miniature type 1S4, but with a filament having a centre tap to permit of either a series-filament or a parallel-filament operating arrangement. The filament current is only 50 mA. with the two filaments in series. This type is not at present available from stock.

Radiotron 815 is a new push-pull beam power amplifier for use as a transmitting valve at ultra-high frequencies. A single 815 is capable of handling a power input of 75 watts with less than one-quarter watt driving power at frequencies as high as 150 Mc/s. The maximum plate dissipation is 25 watts total. The heaters of the 815 are arranged for either 12.6 or 6.3 volt operation.

Radiotron 826 is a transmitting triode having a plate dissipation of 60 watts, and has been designed especially for use at ultra-high frequencies. It may be used at maximum ratings at frequencies as high as 250 Mc/s. and at reduced ratings at frequencies as high as 300 Mc/s. The 826 features a double helical filament centre-tapped within the valve so that effects of filament inductance can be minimised. In addition, two short heavy leads are brought out from the grid and from the plate to individual terminals in order to reduce the inductance of these internal connections. All terminals are placed at one end of the bulb so that short leads can be used for neutralising circuits.

Radiotron 866A/866 is a new half-wave mercury vapour rectifier intended to supersede the well-known types 866A and 866. This new valve combines the ability of the 866A to withstand high peak inverse voltage and the ability of the 866 to conduct at relatively low applied voltage. It employs a ceramic cap insulator and is constructed in a dome-shaped bulb. This construction minimises the danger of bulb cracks caused by corona discharge.

Types 866 and 866A of Australian manufacture will continue to be available for a limited time.

Radiotron 1603 is now available from stock at a nett price of 20/-. As previously announced, this type is now Australian-made.

Radiotron 1625 is a transmitting beam power amplifier similar to type 807 but with a 12.6 volt heater and a 7-pin base.

Radiotron 1626 is a transmitting triode of the indirectly heated type having a maximum plate dissipation of 5 watts and a 12.6 volt heater. It is designed especially as an R.F. oscillator in applications requiring unusual stability of characteristics. It may be operated at maximum ratings at frequencies as high as 30 Mc/s. and at reduced ratings at frequencies as high as 90 Mc/s.

Radiotron D63/6H6-G. This is a new valve type, of English manufacture, which is a close equivalent of types 6H6 and 6H6-G and may, in most cases be used as a replacement for these latter types. Type D63/6H6-G has a metallised bulb which avoids the necessity for a shield can. This type is now available from stock.

Radiotron KT32/25L6-G. Further quantities of this type have been landed and are now available.

Radiotron L63/6J5-G. This is a new valve type, of English manufacture, which is a close equivalent of type 6J5-G and may, in most cases, be used as a direct replacement for the latter type. Type L63/6J5-G is now available from stock.

Radiotron N14/1C5-G. This is a new valve type, of English manufacture, which is a close equivalent of type 1C5-G and may, in most cases, be used as a direct replacement for the latter type. Type N14/1C5-G is now available from stock.

Radiotron U52/5U4-G. Further quantities of this type have been landed and are now available.

Radiotron X64/6L7-G. This is a new valve type, of English manufacture, which is a close equivalent of type 6L7-G and may, in most cases, be used as a direct replacement for the latter. Type X64/6L7-G is now available from stock.

RADIOTRON DESIGNER'S HANDBOOK

The third edition of the Radiotron Designer's Handbook has met with a very enthusiastic response not only in Australia but also overseas. Information has been received from England that it has been favourably received there and a further large order has been placed which should have been despatched by the date that this issue is in print.

A total of 15,000 copies of the third edition has now been printed and of this total, 14,000 have already been sold. The latest impression incorporates some corrections of printing errors and is also being made available with a sewn binding, so that it may be opened flat on the table. An improved cover has also been used so as to make it a more permanent book of reference.

RADIOTRON DESIGNER'S HANDBOOK Correction

On page 211 of the third edition of the Radiotron Designer's Handbook (first impression) the square root sign was inadvertently omitted from the formula for relative amplification under the heading "Primary (or Choke) Inductance". The formula should read

$$\text{Relative Amplification} = \frac{1}{\sqrt{1 + (r_p/\omega L)^2}}$$

RADIOTRON RECEIVING TYPE MANUAL RC-14

The previous shipment of RC-14 Manuals met with a demand in excess of the number available, and the supply was quickly exhausted. A fresh shipment has now arrived and copies of this Manual are available at a price of 2/- posted. In order to be sure of obtaining a copy you are urged to make early application.

REVISED PHOTOTUBE CHARACTERISTICS

Certain revisions have been made in the published characteristics for phototubes, particularly in respect of ambient temperature and the luminous sensitivity of gas-filled types at frequencies of 1,000 and 5,000 c/s. These changes, together with one or two other minor changes, have been incorporated in the tabulated characteristics in this issue. Corrections to other published data will be made at the earliest opportunity and in the meantime it may be taken that these modified characteristics supersede all those previously published.

INDEX FOR 1940

A comprehensive index for Radiotronics for 1940 has been prepared and is supplied as a supplement with this issue. Every effort has been made to provide an index of an unusually comprehensive nature so as to be of the greatest assistance in referring to past articles.



PHOTOTUBE RE

With the recent introduction of new units, RCA rounds out the most complete and diversified line of phototubes for all purposes. Small in size, inexpensive, each has been designed to meet the most exacting requirements of size, spectral response, sensitivity, stability and long life. Although

NO.	NAME OR DESCRIPTION	PRINCIPAL USE		CATHODE		SENSITIVITY μ AMP./LUMEN			SPECTRAL SENSITIVITY CURVE
				SURFACE	WINDOW AREA SQ. IN.	0 CYCLES	1000* CYCLES	5000* CYCLES	
868	GAS	Sound Reproduction	D-1	S1	0.9	55	50	48	C-1
917	VACUUM with Anode Cap	Relays and Measurements	D-2	S2	0.9	20	20	20	C-2
918	GAS	Sound Reproduction	D-1	S2	0.9	110	102	93	C-2
919	VACUUM with Cathode Cap	Relays and Measurements	D-2	S2	0.9	20	20	20	C-2
920	TWIN (Gas Type)	Sound Reproduction	D-3	S1	0.3	75	70	63	C-1
921	GAS (Cartridge Type)	Sound Reproduction	D-4	S2	0.4	100	97	90	C-2
922	VACUUM (Cartridge Type)	Relays and Measurements	D-4	S2	0.4	20	20	20	C-2
923	GAS	Sound Reproduction	D-5	S2	0.4	100	93	84	C-2
924	GAS (End Type)	Relays	D-6	S1	0.2	55	Less than 55	Less than 55	C-1
925	VACUUM	Relays	D-7	S1	0.4	15	15	15	C-1
926	VACUUM (Cartridge Type)	Colorimetry	D-4	S3	0.4	6.5	6.5	6.5	C-3
927	GAS	Sound Reproduction	D-8	S1	0.4	75	Less than 75	Less than 75	C-1
928	GAS (Non-Directional Type)	Relays	D-9	S1	0.7	65	Less than 65	Less than 65	C-1
929	VACUUM	Relays and Measurements	D-10	S4	0.6	45	45	45	C-4

* These sensitivity values are measured with a light input varied sinusoidally about a mean from zero to a maximum of twice the mean. The sensitivity values shown are the ratio amplitude of variation in the current output to the amplitude of variation in the light input. Sensitivity of the gas phototubes was measured with a 90-volt supply, a 1-megohm load, mean light input of 0.015 lumen. Sensitivity of the vacuum phototubes was measured with a 250-volt supply, a 1-megohm load, and a mean light input of 0.1 lumen.

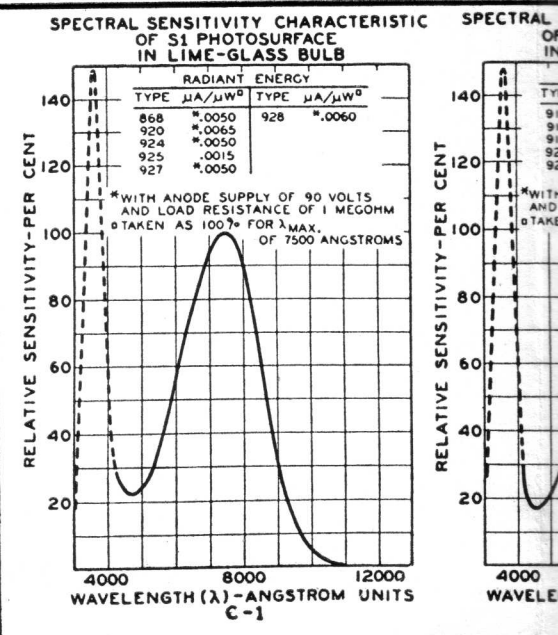
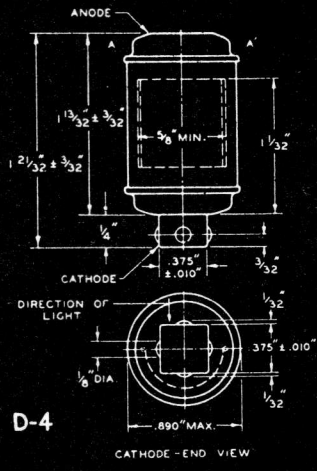
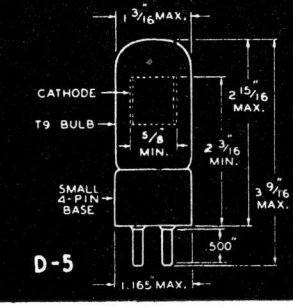
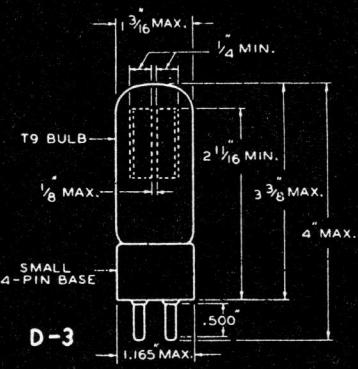
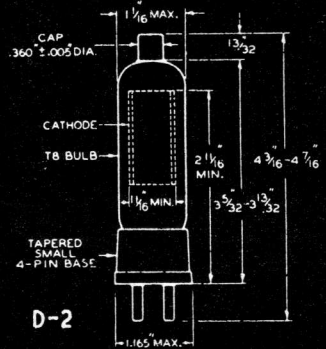
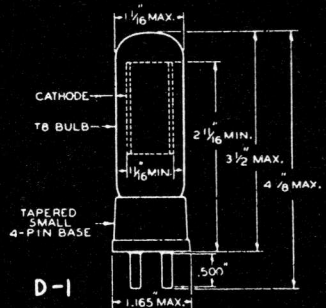

REFERENCE CHART

the most complete, small in size and meeting requirements. Although the

following chart gives essential characteristics of each type, more detailed data and general technical information may be had upon request to the Unified Sales Engineering Service, Amalgamated Wireless Valve Co. Pty. Ltd., Box 2516 BB, G.P.O., Sydney. (Telephone BO 522, Extensions 364, 365.)

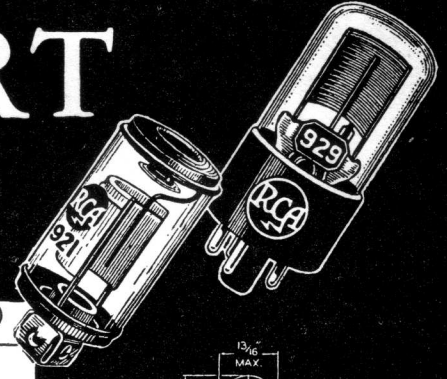

SPECTRAL SENSITIVITY CURVE	GAS AMPLIFICATION FACTOR Δ	DIRECT INTER-ELECTRODE CAPACITANCE μf	MAX. AMBIENT TEMPERATURE $^{\circ}\text{C}$	MAX. ANODE SUPPLY D-C OR PEAK-A-C VOLTS	MAX. ANODE CURRENT $\mu\text{AMP.}$	MIN. D-C LOAD RESISTANCE (MEG OHMS) FOR					
						UPTO 75-V SUPPLY		90-V SUPPLY		250-V SUPPLY	500-V SUPPLY
						BELOW 3.5 $\mu\text{AMP.}$	BELOW 2 $\mu\text{AMP.}$	ABOVE 2 $\mu\text{AMP.}$			
C-1	Not over 7	2.4	50	90	20	0	0.1	2.5	—	—	
C-2	—	2.0	50	500	30	0	0	0	1	10	
C-2	Not over 10	2.4	50	90	20	0	1	4	—	—	
C-2	—	2.0	50	500	30	0	0	0	1	10	
C-1	Not over 10	1.5 $\#$	50	90	10	0	1.0	4	—	—	
C-2	Not over 10	1.1	50	90	20	0	1	4	—	—	
C-2	—	0.6	50	500	30	0	0	0	1	10	
C-2	Not over 10	2.1	50	90	20	0	1	4	—	—	
C-1	Not over 8.5	2.6	50	90	15	0	0.1	2.5	—	—	
C-1	—	1.0	50	250	20	0	0	0	1	—	
C-3	—	0.6	50	500	20	0	0	0	1	10	
C-1	Not over 7	2.0	50	90	10	0	0.1	2.5	—	—	
C-1	Not over 10	2.8	100	90	15	0	1	4	—	—	
C-4	—	2.5	100	250	20	0	0	0	1	—	

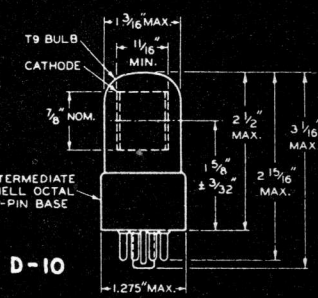
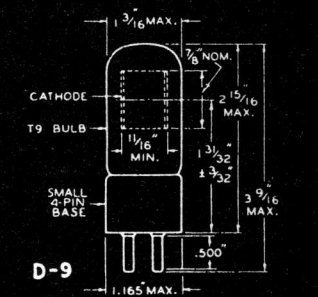
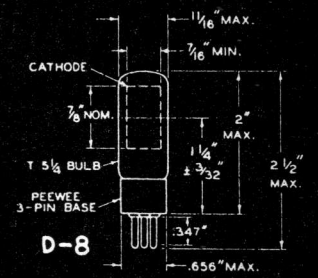
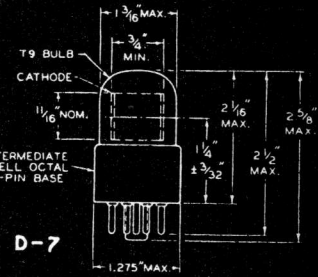
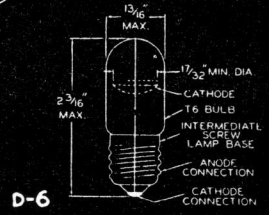

about a mean value are the ratio of the light input. The temperature of 2870°K. megohm load, and as measured with a

- Δ Ratio of sensitivity at maximum anode voltage to sensitivity at a voltage sufficiently low (approximately 25 volts) to eliminate gas ionization effects.
- On basis of the use of a sensitive cathode area $1/2$ " in diameter.
- Values are for each unit.
- $\#$ Between cathode and anode of each unit. Capacitance between cathodes = 1.6 μf , between anodes = 0.4 μf .

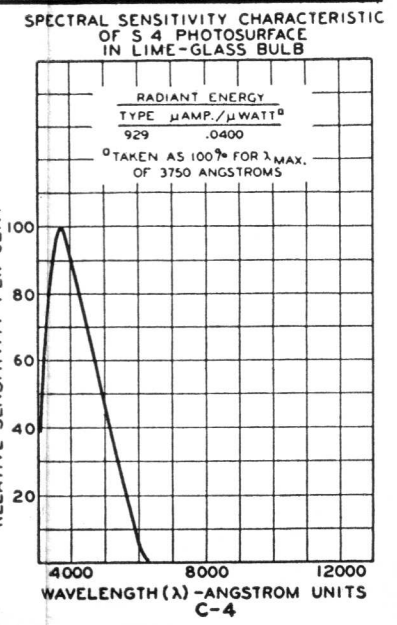
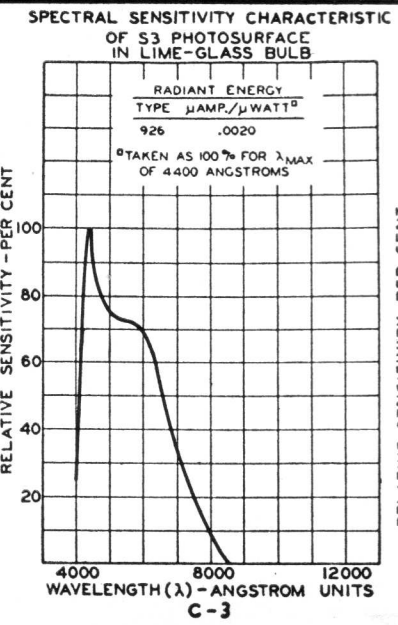
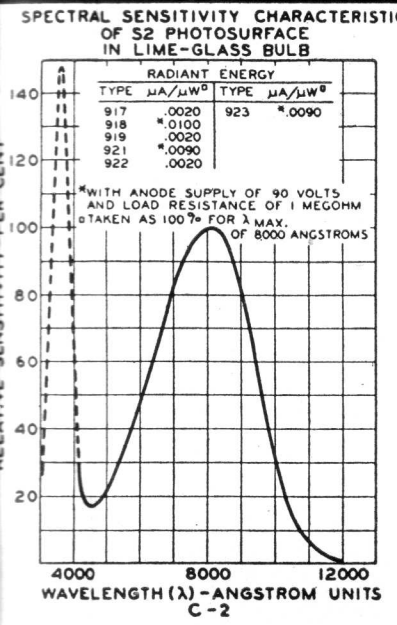

SEE BACK OF CHART FOR SOCKET CONNECTIONS.
DECEMBER, 1940.

PHOTOTUBE SOCKET CONNECTIONS

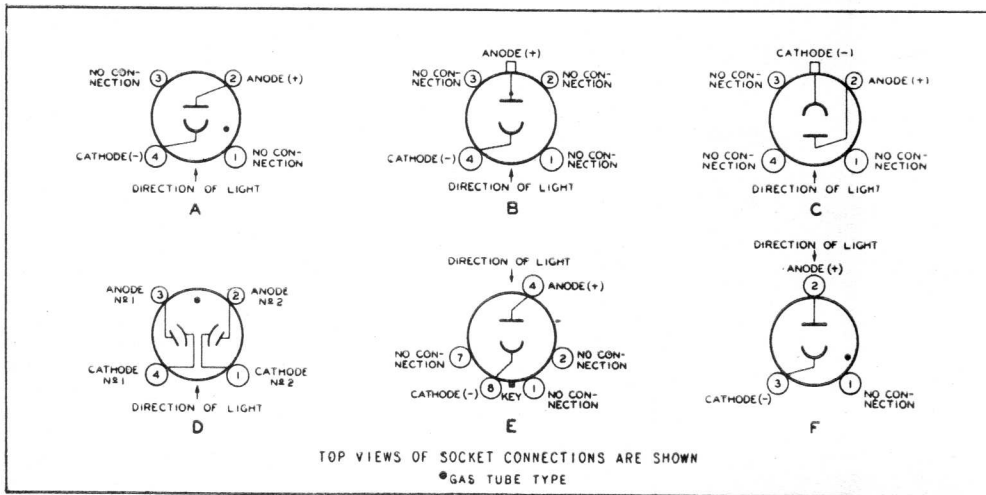

Phototube Type	Socket Connection	Phototube Type	Socket Connection
868	A	923	A
917	B	924	—
918	A	925	E
919	C	926	—
920	D	927	F
921	—	928	A
922	—	929	E