

**Mullard
Valve Data Book
1951**

CONTENTS

	<i>Page</i>
1. Index to Valve Types	4
2. Valve Type Nomenclature	7
3. General Operational Recommendations	10
4. Valve Data—Preferred Types	15
(A) Voltage Amplifying Pentodes	15
(B) Frequency Changers	43
(C) Diodes and Double Diodes	61
(D) Voltage Amplifying Triodes	65
(E) Output Pentodes	79
(F) Rectifiers	111
(G) Electron Beam Indicators	123
(H) Transmitting Valves and Mercury Vapour Rectifiers	125
(I) Neon Stabilising Tubes	153
(J) Oscilloscope and Picture Tubes	157
(K) Gas-filled Triodes and Tetrodes	167
(L) Photographic Flash Tubes	171
(M) Photocells	173
5. Valve Data—Current Maintenance Types	175
6. Valve Data—Obsolescent Types	181
7. Valve Data—Valve Bases	185
8. Valve Data	191
(A) Direct Equivalents	191
(B) Near Equivalents	201
9. Valve Data—Substitutions for Obsolete Type Valves	209
10. General Technical Data	215
(A) Resistor and Capacitor Colour Codes	215
(B) Standard Resistor Values	216
(C) Inductive and Capacitative Reactances	217
(D) ABAC—Ohm's Law	218
(E) Decibel Conversion Chart	220
(F) B.B.C. Television Frequency Allocation	221
(G) Wavelength—Frequency Chart	222
(H) Photocells	223
(I) Useful Formulae	225
General Technical Data—Circuits	227
4-Valve Miniature Battery-operated Receiver	228
4+1 Valve A.C. Mains-operated Superheterodyne Receiver	230
3+1 Valve D.C./A.C. Mains-operated Superheterodyne Receiver	232
3-Valve Battery-operated Gramophone Amplifier	235
3-Watt A.C. Mains-operated A.F. Amplifier with Selective Feedback	236
10-Watt D.C./A.C. Mains-operated Push-pull A.F. Amplifier	238
10-Watt or 30-watt A.C. Mains-operated Push-pull A.F. Amplifier	240
Amplifier, Time-base and Power Supply Unit for Oscilloscope..	243
Voltage-regulated Power Supply Unit	246
Portable Battery-operated Photographic Flash Equipment	247

List of Symbols



INDEX TO VALVE TYPES

GENERAL INDEX TO VALVE TYPES

In this section every valve included in this Manual is listed in alpha-numerical order.

	Page		Page		Page
A		DG7—5	159	EC31	69
ACO42	178	DG7—6	160	EC52	127
ACO44	178	DK1	210	EC53	127
ACO54	210	DK32	44	EC91	128
ACO64	210	DK91	45	ECC31	70
ACO84	210	DL2	210	ECC32	211
ACO84N	210	DL33	83	ECC33	72
AC104	210	DL35	83	ECC34	73
AL60	182, 210	DL66	84	ECC35	74
AZ1	177	DL71	85	ECC40	75, 130
AZ2	210	DL72	86	ECH2	211
AZ3	182, 210	DL92	87	ECH3	179
AZ31	112	DL93	88, 126	ECH21	46
AZ32	210	DL94	89	ECH33	211
AZ33	210	DO25	210	ECH35	48
		DO26	183	ECH42	49
		DO30	178	ECL80	92
		DR4—2	158	ECR30	161
		DR7—5	159	ECR35	161
C		DR7—6	160	ECR35P	161
CBL1	180	DT3	210	ECR60	162
CBL31	81	DT30	210	EE50	179
CCH35	44	DW2	177	EF2	211
CL4	180	DW3	182, 210	EF5	211
CL6	183, 210	DW4	182, 210	EF6	184, 211
CL33	82	DW4—350	177	EF8	184, 211
CY1	180	DW4—500	177	EF9	179
CY2	183, 210			EF22	24
CY31	112, 180			EF36	25, 179
CY32	210			EF37	25
				EF37A	25
		E		EF38	211
		EA50	62	EF39	27
		EAB1	184, 209, 211	EF40	27
		EAC91	45	EF41	27
D		EAFA1	211	EF42	30
DAC1	210	EAFA2	22	EF50	31
DAC32	66	EB4	184, 211	EF54	31
DAF91	17	EB34	62	EF55	32
DB4—2	158	EB41	62	EF80	33
DB7—5	159	EB91	63	EF91	34
DB7—6	160	EBC3	179	EF92	36
DF1	210	EBC33	66	EFM1	209, 211
DF33	18	EBC41	67	EH2	211
DF66	19	EBF80	23	EK2	179
DF70	20	EBL1	179	EK3	184, 211
DF91	20	EBL21	90		
DF92	21	EBL31	91		
DG4—2	158				



INDEX TO VALVE TYPES

	Page		Page		Page
S		U		2D2	181, 209, 213
S4V	212	UAF41	213	2D4	213
S4VA	182, 212	UAF42	37	2D4A	176
S4VB	182, 212	UB41	63	2D13	213
SD4	182, 209, 212	UBC41	77	2D13A	183, 213
SP2	175	UBF80	38	2D13C	183, 214
SP4	176	UBL21	107	2D21	169
SP4B	176	UCH21	54	20AV	173
SP4C	182, 212	UCH42	55	20CG	173
SP13	180	UF41	39	20CV	177
SP13C	180	UF42	41	52CG	173
		UL41	108	55CG	173
		UM34	124	85AI	155
		UR1	213	90AV	173
		UR1C	180	90CG	173
		UR2	213	90CV	173
		UR3	213	054V	213
		UR3C	180	104V	182
		UY21	120	164V	182, 214
		UY31	183, 213	244V	182, 214
		UY41	121	354V	176
				484V	182, 214
				994V	182
				1267	168
				4687	154
				4687A	154
				7475	154
T		V			
TDD2	181, 213	VM4V	182, 213		
TDD2A	175	VP2	175		
TDD4	176	VP2B	175		
TDD13	183, 213	VP4	176		
TDD13C	180	VP4A	176		
TH4	182, 213	VP4B	176		
TH4A	182, 213	VP13A	180		
TH4B	176	VP13B	180		
TH21C	180				
TH22C	213				
TH30C	180				
TH62	213				
TT4	176				
TV6	213				
TY2—125	131				



VALVE TYPE NOMENCLATURE

I. RECEIVING VALVES

The type nomenclature for Mullard Receiving Valves generally consists of two or three letters followed by two figures. These symbols provide information concerning the principal uses of the valves, the heater or filament rating, and the type of base, according to the following code :—

The first letter indicates the filament or heater voltage or current :

A—4.0 V filament	G—5.0 V heater
C—200 mA heater	K—2.0 V filament
D—0.5 V to 1.5 V filament	P—300 mA heater
E—6.3 V heater	U—100 mA heater

The second and subsequent letters indicate the general class of valve :

A—single diode	H—hexode	Q —nonode
B—double diode	K—heptode or octode	
C—triode	L—output pentode	X —full-wave gas-filled rectifier
D—output triode	M—electron beam indicator	Y—half-wave rectifier
E—tetrode	N—gas triode	Z—full-wave rectifier
F—voltage amplifying pentode	*P—secondary emission valve	

*Used as a third letter only.

Note : Two of the above letters may be combined, e.g., BC—double diode triode.

The first figure indicates the type of base :

2—B8G (Loctal) base	6 & 7 Sub-miniature construction
3—Octal base	8—B9A (Noval) base
4—B8A base	9—B7G base
5—B9G and other special bases	

The second figure indicates the order of development, and serves to distinguish between two or more valves of the same type but of different performance ratings.

Example : ECH35 E C H 3 5
 6.3 V heater triode hexode octal base fifth development



2 VALVE TYPE NOMENCLATURE

VALVE TYPE NOMENCLATURE

2. TRANSMITTING VALVES

The type nomenclature for valves included in the Transmitting and Industrial range consists of two or more letters followed by two sets of figures. These symbols provide information concerning the principal uses and power ratings of the valves, according to the following code. It is pointed out, however, that in a very few instances, it has not been possible to adhere strictly to this code

The first letter indicates the general class of valve :

- M—Triode suitable for use as a low frequency power valve in amplifiers, or as a modulator in transmitting equipment.
- P—R.F. power pentode
- Q—R.F. power tetrode
- T—R.F. power triode
- R—Rectifier

Note : For valves having dual systems, the code letters for both systems are used—e.g., "QQ" denotes a double tetrode.

The second letter indicates the type of cathode :

- X—Directly heated. Tungsten filament.
- Y—Directly heated. Thoriated Tungsten filament.
- *Z—Directly heated. Oxide-coated filament.
- V—Indirectly heated. Oxide-coated cathode.

* For mercury-vapour rectifiers, all of which have oxide-coated filaments, the letter "G" is used in place of "Z", to avoid confusion with high vacuum rectifiers.

The third letter. Valves having silica envelopes are distinguished by the letter "S" following the second letter of the type nomenclature.

The first group of numbers, immediately following the letters shows the approximate anode voltage in kilovolts :

- Thus, 05 represents 0.5 KV = 500 V.
- 1 represents 1 KV = 1,000 V.
- 2 represents 2 KV = 2,000 V.



The second group of figures varies in significance according to the type and size of the valve :

- (a) For L.F. and R.F. power valves up to 5 KW dissipation, the figures indicate the maximum permissible anode dissipation in watts ;
- (b) For larger water-cooled valves the figures indicate the output in kilowatts—the anode dissipation of such valves is not usually an important limiting factor ;
- (c) For all types of rectifiers the figures indicate the maximum rectified output current in milli-amperes per valve.

Examples

- QY2-100 —R.F. power tetrode with thoriated tungsten filament. Rated to work at 2,000 V and to dissipate 100 watts continuously.
- QQV07-40 —Twin beam-tetrode with indirectly-heated oxide-coated cathode. Rated to work at 750 V and to dissipate 40 watts continuously (20 watts at each anode).
- TX12-20W —R.F. power triode, water-cooled, with tungsten filament. Rated to work at 12,000 V and for an output of 20 KW.
- RG3-250 —Mercury-vapour rectifier rated to work at 3,000 V and to give a maximum rectified output of 250 mA.



GENERAL OPERATIONAL RECOMMENDATIONS

I. VACUUM VALVES

Interpretation of Data

The principal characteristics quoted for each valve in this book are normally those corresponding to a value of anode current representing typical operating conditions. The control grid voltage given for this anode current is approximate only, the anode current being taken as the standard.

The values given are the mean values of measurements made on a large number of valves.

Where the "equivalent noise resistance" (R_{eq}) is quoted, this is the value of a resistance which, if introduced into the grid circuit of a perfectly noiseless valve, would produce noise of the same level as that of the shot and partition noise occurring in the actual valve.

The values of input damping resistance represent the extent to which a parallel tuned circuit would be damped by the valve at the stated frequency.

Limiting Values

The operating maxima quoted on individual data sheets should on no account be exceeded. The following general limitations should also be observed, and should be interpreted in conjunction with British Standard Specification No. 1106, "Code of Practice on the Use of Radio Valves in Equipment", upon which these notes have, in part, been based.

Where reference is made to a particular electrode, it should also be considered as referring to an electrode performing a similar function in a more complex valve.

Filament

(a) Valves with 2-volt Filaments

The filament voltage should be maintained between ± 7 per cent. of the rated value. If, however, some variation of the valve characteristics is acceptable, the filament voltage limits may be extended to ± 10 per cent.

(b) Valves with 1.4-volt Filaments

- (i) *Dry-battery Operation.* Valves with 1.4-volt filaments are designed to be operated from a dry-cell battery with a rated terminal voltage of 1.5 V. In no circumstances should the voltage across any 1.4-volt section of filament exceed 1.6 V. If these valves are operated with their filaments in series from dry batteries with a higher terminal voltage, shunting resistors may be required to ensure the correct voltage across individual 1.4-volt filaments.
- (ii) *Accumulator or Mains Operation.* When valves with 1.4-volt filaments are operated from an accumulator or from a mains supply unit, the voltage drop across each 1.4-volt section of filament of valves with rated filament current should have a nominal value of 1.3 V and should be maintained between 1.25 V and 1.4 V at normal line voltage, that is to say at voltages equivalent to 2 volts per cell for accumulators or to nominal line voltage for supply mains. If the filaments are operated in series, shunting resistors may be required to ensure the correct voltage across individual 1.4-volt filaments.



(c) Thoriated Tungsten Filaments

With thoriated tungsten and oxide-coated filaments, temporary variations of filament voltage due to mains fluctuations and so forth are permissible provided they do not exceed ± 5 per cent. ; but any permanent deviation from the published figures will definitely reduce the life of the valve. With this type of filament under-running may result in more serious damage than over-running.

Heater (indirectly-heated valves)

Heater voltages should be maintained within ± 7 per cent. of the rated values. Under-running the heater may cause as much damage to a valve as over-running. Where it is permissible to operate heaters in series, this is clearly stated in the data. When heaters are so operated the heater current should be maintained within ± 5 per cent. of the rated value.

Cathode

Cathode voltages, with respect to earth, should be kept as low as possible. Maximum values for specific valves are indicated in the data.

In order to avoid hum and instability, the heater-cathode path should not be included either in the A.F. or the R.F. circuit. This precaution is particularly important where the signal level is low.

Disintegration of the cathode coating may occur in both indirectly-heated and directly-heated rectifiers if the total resistance in series with the anode is less than that specified in the data for the particular valve. The value of the resistance depends upon the effective resistance, R_t , due to the transformer.

$$R_t = R_s + n^2R_p$$

where :

R_s = Resistance of the transformer secondary in anode circuit.

R_p = Resistance of the transformer primary.

n = Primary to secondary ratio in half-wave circuits or primary to half secondary ratio in full-wave circuits.

If the resistance R_t is less than the minimum specified value for the series resistance, an additional series resistance must be included.

Unless otherwise stated the maximum cathode-to-heater voltage specified for a particular valve is intended to be the D.C. value or the R.M.S. value provided that the peak value does not exceed 1.4 times this figure. This point should receive particular attention in inverse feed-back circuits in which the cathode bias resistor is not decoupled.

Control Grid

The resistance in series with the control grid must be kept as low as possible, and should in no circumstances exceed the maximum value quoted in the data. Care should be taken when selecting valves for use as oscillators or for other circuit conditions where appreciable grid current is drawn, to ensure that the maximum grid ratings are not exceeded.

If grid bias is provided by grid rectification, precautions should be taken to ensure that the valve ratings will not be exceeded in the event of loss of drive. Normally this risk is avoided by providing a certain amount of cathode bias.



3 GENERAL OPERATIONAL RECOMMENDATIONS

Screen Grid

In circuits where large anode voltage swing occurs, care should be taken that the maximum screen-grid dissipation is not exceeded.

The method of feeding the screen grid will have a considerable effect on the cross-modulation characteristics of valves designed for operation over a large A.V.C. range. Recommendations in this connection are given in the data for individual valves.

Suppressor Grid

Suppressor grids should be maintained at cathode potential, except in applications for which conditions involving the application of voltage to the suppressor grid are quoted in data.

For applications where it is desired to employ the secondary emission characteristic of a valve, it should be noted that this characteristic may vary considerably between valve and valve, and the circuit design should not be critical in this respect. On account of this variability, the use of this characteristic is in general not recommended.

Mounting

Care should be taken when mounting in a horizontal position indirectly-heated valves having high mutual conductance and directly-heated valves having long filaments to ensure that the major axis of the first grid or the plane of the filament is vertical.

Valves not falling within this category may be mounted in any position.

Ventilation

Adequate ventilation for the dissipation of heat must be provided, particularly for power valves and rectifiers.

General

Valves should not be operated without a D.C. connection between each electrode and the cathode. Any apparent advantage to be gained by so doing may be neutralised by secondary emission from the electrode concerned.

2. MERCURY VAPOUR RECTIFIERS

Filament Supply

(a) When a mercury vapour rectifier is first installed, and before it is put into service, the valve should be run for at least half an hour at its normal filament voltage but without H.T., in order to vaporise any mercury which may have been deposited on the anode or cathode during transit. This precaution should also be taken before putting into service a mercury vapour rectifier which has been out of use or in store for any considerable period.

(b) When starting up the equipment at any time, the filament must be allowed to attain full working temperature and the condensed mercury temperature



must be within the prescribed limits, before the anode supply is switched on. Unless otherwise stated, this requires a delay of at least one minute and considerably longer if the ambient temperature is appreciably less than the prescribed condensed mercury temperature. The delay is preferably obtained by an automatic switch.

Neglect of either precautions (a) or (b) may result in immediate and irreparable damage to the valve.

(c) It is very important that the filament voltage is accurately adjusted to the correct value. A permanent deviation greater than 2 per cent. may result in a considerable reduction in the life of the valve. Temporary fluctuations, not exceeding 5 per cent., will not appreciably affect the life of the valve.

(d) To ensure maximum life from a directly heated valve, it is advisable that the filament supply should be $90^\circ \pm 30^\circ$ out of phase with the anode supply.

Mounting and Cooling

Mercury vapour rectifiers must always be mounted vertically with the cathode connections at the lower end.

Any increase of temperature above the specified value reduces the safe peak inverse voltage of the valve.

Free circulation of air must be provided and if any form of screening box is employed it must have suitable openings at top and bottom for ventilation. It is preferable, however, to use expanded metal or close wire mesh for the screen.

The figures for the condensed mercury temperatures specified in the data should be taken as the limiting conditions, since this is the factor which determines both the safe peak inverse voltage and the life of the cathode. The ambient temperature is given only for guidance in equipment not using forced air cooling.

Screening and R.F. Filter Circuits

(a) In order to prevent ionisation of the mercury vapour (and consequent flash-over) due to strong R.F. fields, it may be necessary to enclose the rectifiers in a separate earthed screening box. For the same reason R.F. filters should be employed to prevent high-frequency current being passed back to the rectifiers, by way of the H.T. supply leads or other wiring.

(b) High-frequency disturbances, usually due to oscillation in the transformer windings, are often produced by mercury vapour rectifiers, and may cause interference in receiving apparatus situated near the rectifier unit. Small R.F. chokes or resistors in the anode leads will generally reduce the interference, and screening as recommended in paragraph (a) above may also be adopted, with R.F. filters in all leads emerging from the screen.

Short Circuit Protection

To prevent damage to the rectifier in the event of a short circuit on the D.C. side it is advisable to include a fuse of suitable rating in the anode circuit of each rectifier.



3 GENERAL OPERATIONAL RECOMMENDATIONS

Smoothing Circuits

In order to limit the peak anode current in a rectifier it is necessary that a choke, having the specified minimum inductance, should precede the first smoothing capacitor.

To ensure good voltage regulation on fluctuating loads, the value of C should be suitable for the maximum current to be taken and the value of L should be large enough to give uninterrupted current at minimum load.

The output voltages quoted in the data refer to ideal conditions and in practice allowance must be made for voltage losses in the choke and transformer. When rectifier circuits are designed to provide maximum output voltage at a specified load, the permissible peak inverse voltage will be exceeded if the load current is decreased.



VOLTAGE AMPLIFYING PENTODES A**VOLTAGE AMPLIFYING PENTODES****BATTERY**

Type	Description	V_f	Base	Page
DAF91	Miniature single diode A.F. pentode	1.4	B7G	17
DF33	Variable- μ H.F. pentode	1.4	Octal	18
DF66	Sub-miniature A.F. pentode ...	0.625	B5A	19
DF70	Sub-miniature A.F. pentode ...	0.625	B8D	20
DF91	Miniature variable- μ H.F. pentode	1.4	B7G	20
DF92	Miniature H.F. pentode with sharp cut-off characteristics	1.4	B7G	21
KF35	Variable- μ H.F. pentode	2.0	Octal	36

A.C. MAINS

Type	Description	V_h	Base	Page
*EAF42	Single diode variable- μ H.F. or A.F. pentode	6.3	B8A	22
†EBF80	Double diode variable- μ H.F. or A.F. pentode	6.3	Noval (B9A)	23
*EF22	Variable- μ H.F. pentode ...	6.3	Loctal (B8G)	24
*EF36	A.F. pentode	6.3	Octal	25
*EF37	Low microphony A.F. pentode ...	6.3	Octal	25
*EF37A	Low microphony, low hum A.F. pentode	6.3	Octal	25
*EF39	Variable- μ H.F. pentode ...	6.3	Octal	27
*EF40	Low microphony A.F. pentode ...	6.3	B8A	27
*EF41	Variable- μ H.F. pentode ...	6.3	B8A	29
EF42	H.F. pentode with sharp cut-off characteristics	6.3	B8A	30
†EF50	Short wave H.F. pentode with sharp cut-off characteristics	6.3	B9G	31
†EF54	V.H.F. pentode with sharp cut-off characteristics	6.3	B9G	31
EF55	V.H.F. pentode with sharp cut-off characteristics	6.3	B9G	32



4 VALVE DATA PREFERRED TYPES

A VOLTAGE AMPLIFYING PENTODES

A.C. MAINS (contd.)

Type	Description	V_h	Base	Page
†EF80	Television H.F. pentode for use as R.F. or I.F. amplifier, video amplifier or as frequency changer ...	6.3	Noval (B9A)	33
†EF91	Miniature H.F. pentode suitable for use as amplifier or as frequency changer	6.3	B7G	34
*EF92	Miniature H.F. pentode with variable- μ characteristics ...	6.3	B7G	34

*These valves have heaters rated at 0.2 A and suitable for either parallel or series operation.

†These valves have heaters rated at 0.3 A and suitable for either parallel or series operation.

D.C./A.C. MAINS

Type	Description	I_h	Base	Page
UAF42	Single diode variable- μ H.F. or A.F. pentode	0.1	B8A	37
UBF80	Double diode variable- μ H.F. or A.F. pentode	0.1	Noval (B9A)	38
UF41	Variable- μ H.F. pentode ...	0.1	B8A	39
UF42	H.F. pentode with sharp cut-off characteristics	0.1	B8A	41

VALVE DATA
PREFERRED TYPES **4**

VOLTAGE AMPLIFYING PENTODES **A**

Miniature single diode pentode with sharp cut-off characteristics, primarily intended for use as A.F. voltage amplifier. The diode section, which is located at the negative end of the filament is available as demodulator or as A.V.C. rectifier

DAF 91

FILAMENT

V_f 1.4 V I_f 0.05 A Suitable for D.C. operation only

CAPACITANCES

C_{a-g_1}	0.2	$\mu\mu\text{F}$
C_{in}	2.2	$\mu\mu\text{F}$
C_{out}	2.4	$\mu\mu\text{F}$

CHARACTERISTICS

V_a	67.5	90	V
V_{g_2}	67.5	90	V
V_{g_1}	0	0	V
I_a	1.6	2.7	mA
I_{g_2}	0.4	0.5	mA
g_m	625	720	$\mu\text{A}/\text{V}$
r_a (approx.)	0.6	0.5	$\text{M}\Omega$

OPERATING CONDITIONS

As R.C. coupled A.F. amplifier ($V_{g_1} = 0$)

V_b	45	45	45	45	45	45	45	45	45	V
R_a	0.27	0.27	0.27	0.47	0.47	0.47	1.0	1.0	1.0	$\text{M}\Omega$
I_a	80	80	80	50	50	50	25	25	25	μA
R_{g_2}	1.0	1.0	1.0	1.8	1.8	1.8	3.9	3.9	3.9	$\text{M}\Omega$
I_{g_2}	23.2	23.2	23.2	14.6	14.6	14.6	7.7	7.7	7.7	μA
$R_{g_1}^*$	0.47	1.0	4.7	1.0	4.7	10	2.2	4.7	10	$\text{M}\Omega$
$V_{out(r.m.s.)}$	1.55	1.94	2.25	2.15	2.75	2.85	2.8	3.25	3.5	V
V_{out}/V_{in}	31	38.8	45	43	55	57	56	65	70	
D_{tot}	2.1	1.9	1.2	2.0	1.7	1.6	2.9	2.4	2.0	%
$V_{out(r.m.s.)}$ ($D_{tot}=5\%$)	3.95	6.0	7.55	5.0	7.4	7.6	5.6	6.5	6.9	V
V_{out}/V_{in} ($D_{tot}=5\%$)	30.4	35.3	39.7	41.6	49.3	50.6	56	59	62.7	
V_b	67.5	67.5	67.5	67.5	67.5	67.5	67.5	67.5	67.5	V
R_a	0.27	0.27	0.27	0.47	0.47	0.47	1.0	1.0	1.0	$\text{M}\Omega$
I_a	145	145	145	87	87	87	45	45	45	μA
R_{g_2}	1.0	1.0	1.0	1.8	1.8	1.8	3.9	3.9	3.9	$\text{M}\Omega$
I_{g_2}	41	41	41	25	25	25	13	13	13	μA
$R_{g_1}^*$	0.47	1.0	4.7	1.0	4.7	10	2.2	4.7	10	$\text{M}\Omega$
$V_{out(r.m.s.)}$	4.1	5.0	5.7	5.5	6.8	7.0	7.1	8.2	8.65	V
V_{out}/V_{in}	41	50	57	55	68	70	71	82	86.5	
D_{tot}	1.8	1.3	1.6	1.7	2.0	2.1	2.3	2.5	2.7	%
$V_{out(r.m.s.)}$ ($D_{tot}=5\%$)	9.85	12.6	15.2	10.4	13.9	14.8	10.0	12.8	13.4	V
V_{out}/V_{in} ($D_{tot}=5\%$)	37.9	45	50.6	49.6	60.3	61.8	66.8	75.3	78.8	

* Grid resistance of following valve



4 VALVE DATA PREFERRED TYPES

A VOLTAGE AMPLIFYING PENTODES

DAF 91

(contd.)

OPERATING CONDITIONS (contd.)

As R.C. coupled A.F. amplifier ($V_{g1}=0$)

V_b	90	90	90	90	90	90	90	90	90	V
R_a	0.27	0.27	0.27	0.47	0.47	0.47	1.0	1.0	1.0	M Ω
I_a	220	220	220	130	130	130	65	65	65	μ A
R_{g2}	1.0	1.0	1.0	1.8	1.8	1.8	3.9	3.9	3.9	M Ω
I_{g2}	61	61	61	36	36	36	18.7	18.7	18.7	μ A
R_{g1}^*	0.47	1.0	4.7	1.0	4.7	10	2.2	4.7	10	M Ω
$V_{out(r.m.s.)}$	4.9	6.0	6.9	6.65	8.35	8.7	9.0	10.4	11.0	V
V_{out}/V_{in}	49	60	69	66.5	83.5	87	90	104	110	
D_{tot}	0.8	1.4	2.0	1.7	3.1	3.5	3.0	3.3	3.6	°
$V_{out(r.m.s.)}$ ($D_{tot}=5\%$)	14.4	17.5	20	16.5	20.3	21.0	15.1	17.4	17.6	V
V_{out}/V_{in} ($D_{tot}=5\%$)	42.4	51.5	58.9	59	72.5	75	84	96.8	103.5	

*Grid resistance of following valve

LIMITING VALUES

V_b max.	90	V
V_{g2} max.	90	V
V_{g1} max.	0	V
I_k max.	4.5	mA
I_{ad} max.	0.25	mA



BASE :

B7G

DIMENSIONS :

L=54 mm

D=19mm

40

DF 33

H.F. pentode with variable-mu characteristics

FILAMENT

V_f 1.4 V I_f 0.05 A Suitable for D.C. operation only

CAPACITANCES

C_{a-g1}	<0.007	μ F
C_{in}	3.8	μ F
C_{out}	9.5	μ F

OPERATING CONDITIONS

V_b	90	V
V_{g2}	90	V
V_{g1}	0	V
I_a	1.2	mA
I_{g2}	0.3	mA
g_m	750	μ A/V
r_a	1.5	M Ω
V_{g1} ($g_m=5\mu$ A/V)	-4.0	V



VOLTAGE AMPLIFYING PENTODES A

LIMITING VALUES

V_a max.	110	V	DF 33 (contd.)
V_{g2} max.	110	V	

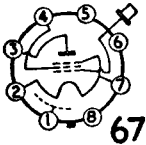

BASE :
Octal

DIMENSIONS :
L=102 mm
D=30 mm

Subminiature A.F. voltage amplifying pentode for use in hearing aids. **DF 66**

FILAMENT

V_f 0.625 V I_f 15mA Suitable for D.C. operation only

MOUNTING POSITION Any

Direct soldered connections to the leads must be at least 5 mm from the seal and any bending of the leads at least 1.5 mm from the seal

CAPACITANCES (measured without external screen)

C_{a-g1}	<0.15	$\mu\mu\text{F}$
C_{in}	1.6	$\mu\mu\text{F}$
C_{out}	2.2	$\mu\mu\text{F}$

CHARACTERISTICS

V_a	22.5	V
V_{g2}	22.5	V
I_a	50	μA
I_{g2}	15	μA
V_{g1}	-1.05	V
g_m	100	$\mu\text{A/V}$
r_a	>2	M Ω
μ_{g1-g2}	11.5	

OPERATING CONDITIONS As R.C. coupled A.F. amplifier

	With fixed bias	With grid current bias	
V_b	22.5	22.5	V
R_a	1.0	1.0	M Ω
R_{g2}	2.0	2.7	M Ω
V_{g1}	-0.625	—	V
R_{g1}	—	10	M Ω
I_k	16	16	μA
V_{out}/V_{in}	33	35	
* R_{g1}	5	5	M Ω

* Grid resistance of following valve

LIMITING VALUES

V_a max.	45	V
V_{g2} max.	45	V
I_k max.	100	μA

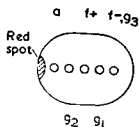

BASE
B5A

DIMENSIONS
L=28 mm (plus 32 mm leads)
D=6.1 mm x 8.4 mm



4 VALVE DATA PREFERRED TYPES

A VOLTAGE AMPLIFYING PENTODES

DF 70

Subminiature A.F. voltage amplifying pentode for use in hearing aids

FILAMENT

V_f 0.625 V I_f 25 mA Suitable for D.C. operation only

Direct soldered connections to the leads of this valve must be at least 5 mm from the seal and any bending of the valve leads must be at least 1.5 mm from the seal

CAPACITANCES (Measured without external screen)

C_{a-g1}	<0.5	$\mu\mu\text{F}$
C_{in}	1.6	$\mu\mu\text{F}$
C_{out}	2.4	$\mu\mu\text{F}$

CHARACTERISTICS

V_a	30	V
V_{g2}	30	V
V_{g1}	0	V
I_a	0.375	μA
I_{g2}	0.125	μA
g_m	0.22	mA/V
r_a	0.5	$\text{M}\Omega$

OPERATING CONDITIONS AS RC COUPLED A.F. AMPLIFIER

V_b	30	30	30	45	V
V_{g1}	-0.625	-0.625	-0.625	-0.625	V
R_{g2}	1.5	3.3	1.5	3.3	$\text{M}\Omega$
I_k	48	24	81	40	μA
R_a	0.47	1.0	0.47	1.0	$\text{M}\Omega$
V_{out}/V_{in}	37	44	43	57	
* R_{g1}	3.3	3.3	3.3	3.3	$\text{M}\Omega$

*Grid resistance of following valve

LIMITING VALUES

V_a max.	45	V
V_{g2} max.	45	V
I_k max.	500	μA



BASE :
B8D

DIMENSIONS :
L = 29.5 mm plus 32 mm lead
D = 10.1 mm

DF 91

Miniature H.F. pentode with variable-mu characteristics

FILAMENT

V_f 1.4 V I_f 0.05 A Suitable for D.C. operation only

CAPACITANCES

C_{a-g1}	<0.01	$\mu\mu\text{F}$
C_{in}	3.6	$\mu\mu\text{F}$
C_{out}	7.5	$\mu\mu\text{F}$



VALVE DATA
PREFERRED TYPES 4

VOLTAGE AMPLIFYING PENTODES A

OPERATING CONDITIONS

V_a	45	67.5	90	90	V
V_{g2}	45	67.5	45	67.5	V
V_{g1}	0	0	0	0	V
I_a	1.7	3.4	1.8	3.5	mA
I_{g2}	0.7	1.5	0.65	1.4	mA
g_m	700	875	750	900	$\mu A/V$
V_{g1} ($g_m = 10 \mu A/V$)	-10	-16	-10	-16	V
r_a	0.35	0.25	0.8	0.5	M Ω
R_{g2}	—	—	68	15	K Ω

DF 91
(contd.)

LIMITING VALUES

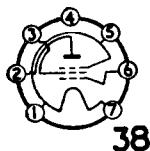

38

V_a max.	90	V
V_{g2} (b) max.	90	V
V_{g2} max.	67.5	V
V_{g1} max.	0	V
I_k max.	5.5	mA

BASE
B7G

DIMENSIONS
L=54 mm
D=19 mm

Miniature H.F. pentode with sharp cut-off characteristics

DF 92

FILAMENT

V_f 1.4 V I_f 0.05 A Suitable for D.C. operation only

MOUNTING POSITION Any

CAPACITANCES (Measured without external screening)

C_{a-g1}	<0.01	$\mu\mu F$
C_{in}	3.6	$\mu\mu F$
C_{out}	7.5	$\mu\mu F$

CHARACTERISTICS

V_a	90	90	V
V_{g2}	45	67.5	V
V_{g1}	0	0	V
I_a	1.9	3.7	mA
I_{g2}	0.7	1.4	mA
g_m	0.85	1.0	mA/V
r_a	0.9	0.5	M Ω
μ_{g1-g2}	11	11	

LIMITING VALUES

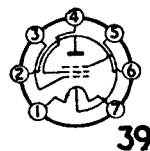

39

V_a max.	90	V
V_{g2} (b) max.	90	V
V_{g2} max.	70	V
V_{g1} max.	0	V
I_k max.	6.0	mA

BASE
B7G

DIMENSIONS
L=54 mm
D=19 mm



EAJ 42 Single diode H.F. pentode with variable- μ characteristics

HEATER

V_h 6.3 V I_h 0.2 A Suitable for series or parallel operation

CAPACITANCES

Pentode Section			Diode Section		
C_{a-g1}	<0.002	$\mu\mu F$	C_{ad-k}	3.8	$\mu\mu F$
C_{out}	5	$\mu\mu F$	C_{ad-g1}	<0.0015	$\mu\mu F$
C_{in}	4.5	$\mu\mu F$	C_{ad-a}	<0.15	$\mu\mu F$

OPERATING CONDITIONS AS R.F. OR I.F. AMPLIFIER

$V_b = V_o$	250	V
R_{g2}	110	K Ω
V_{g2}	85	V
R_k	310	Ω
V_{g1}	-2.0	V
I_a	5.0	mA
I_{g2}	1.5	mA
g_m	2.0	mA/V
r_a	1.4	M Ω
μ_{g1-g2}	18	
* V_{g1}	-43	V
R_{eq}	7.5	K Ω

*For 100:1 reduction in mutual conductance

LIMITING VALUES

Pentode Section

$V_{a(b)}$ max.	550	V
V_a max.	300	V
p_a max.	2	W
$V_{g2(b)}$ max.	550	V
V_{g2} ($I_a = 2.5$ mA) max.	300	V
V_{g2} ($I_a = 5.0$ mA) max.	125	V
p_{g2} max.	0.3	W
I_k max.	10	mA
R_{g1-k} max.	3	M Ω
V_{h-k} max.	100	

Diode Section

V_{ad} (pk.) max.	200	V
I_{ad} max.	0.8	mA
V_{ad} max. ($I_{ad} = +0.3$ μA)	-1.3	V
V_{h-k} max.	100	V



BASE:
B8A

DIMENSIONS:
L=60 mm
D=22 mm

VOLTAGE AMPLIFYING PENTODES A

Double diode variable- μ H.F. or A.F. pentode

EBF 80

HEATER

V_h 6.3 V I_h 0.3 A Suitable for series or parallel operation

Preliminary data

CAPACITANCES

	$C_{a'd-g1}$	<0.0008	$\mu\mu F$
	$C_{a''d-g1}$	<0.001	$\mu\mu F$
	$C_{a'd-a}$	<0.2	$\mu\mu F$
	$C_{a''d-a}$	<0.05	$\mu\mu F$
Pentode Section	C_{a-g1}	<0.0025	$\mu\mu F$
	C_{out}	4.6	$\mu\mu F$
	C_{in}	4.0	$\mu\mu F$
Diode Section	C_{g1-h}	<0.07	$\mu\mu F$
	$C_{a'd-k}$	2.15	$\mu\mu F$
	$C_{a''d-k}$	2.35	$\mu\mu F$
	$C_{a'd-a''d}$	<0.35	$\mu\mu F$

OPERATING CONDITIONS

As R.F. or I.F. amplifier

$V_a = V_b$	250	V
R_{g2}	95	K Ω
V_{g2}	85	V
V_{g3}	0	
I_a	5.0	mA
I_{g2}	1.75	mA
V_{g1}	-2.0	V
R_k	300	Ω
g_m	2.2	mA/V
r_a	1.5	M Ω
μ_{g1-g2}	18	
R_{eq}	6,800	Ω
V_{g1} for 100:1 reduction in g_m	-41.5	V

OPERATING CONDITIONS

μ s R.C. coupled A.F. amplifier

V_b	250	250	250	250	V
R_a	0.22	0.1	0.22	0.1	M Ω
I_a	0.75	1.5	0.75	1.5	mA
R_{g2}	0.82	0.39	0.1	0.47	M Ω
I_{g2}	0.30	0.53	0.25	0.50	mA
R_k	1,800	1,000	0	0	Ω
R_{g1}	1	1	10	10	M Ω
V_{out}/V_{in}	110	80	160	110	
* $V_{out} = (r, m, a,)$	19	18	19	19	V
** R_{g1}	0.68	0.33	0.68	0.33	M Ω

* $D_{tot} = 5\%$

**Grid resistor of following valve



4 VALVE DATA PREFERRED TYPES

A VOLTAGE AMPLIFYING PENTODES

EBF 80 (contd.)

LIMITING VALUES

Pentode Section

$V_{a(b)}$ max.	550	V
V_a max.	300	V
p_a max.	1.5	W
$V_{g2(b)}$ max.	550	V
V_{g2} max. ($I_a < 2.5$ mA)	300	V
V_{g2} max. ($I_a = 5$ mA)	125	V
p_{g2} max.	0.3	W
I_k max.	10	mA
* R_{g1-k} max.	3	M Ω
V_{h-k} max.	100	V
$V_{ad(pk)}$ max.	200	V
I_{ad} max.	0.8	m/
* R_{g1-k} max. = 22M Ω if grid current bias is employed.		

Diode Section



103

BASE:

B9A
(Noval)

DIMENSIONS:

L=67 mm
D=22.2 mm

EF 22

H.F. pentode with variable-mu characteristics

HEATER

V_h 6.3 V I_h 0.2 A Suitable for series or parallel operation

CAPACITANCES

C_{a-g1}	<0.002	$\mu\mu\text{F}$
C_{in}	5.5	$\mu\mu\text{F}$
C_{out}	6.4	$\mu\mu\text{F}$

OPERATING CONDITIONS

V_a	250	250	250	V
V_{g2}	0	0	0	V
R_{g2}	82	82	82	K Ω
R_k	330	330	330	Ω
V_{g1}	-2.5	-46	-58	V
V_{g2}	100	—	250	V
I_a	6	—	—	mA
I_{g2}	1.7	—	—	mA
g_m	2,200	22	4.5	$\mu\text{A/V}$
r_a	1.2	>10	>10	M Ω
μ_{g1-g2}	17	—	—	—
R_{eq}	6.2	—	—	K Ω

LIMITING VALUES

$V_{a(b)}$ max.	550	V
V_a max.	300	V
p_a max.	2	W
$V_{g2(b)}$ max.	550	V
V_{g2} ($I_a < 3.0$ mA) max.	300	V
V_{g2} ($I_a = 6.0$ mA) max.	125	V
p_{g2} max.	0.3	W
I_k max.	10	mA

BASE:
B8G

DIMENSIONS:

L=91 mm
D=29 mm



86



EF36 General purpose A.F. pentode

EF 36

EF37 General purpose low-microphony A.F. pentode

EF 37

HEATER

V_h 6.3V I_h 0.2A Suitable for D.C./A.C. operation

For ratings, characteristics and operating conditions see EF37A below

High gain low microphony, low hum A.F. pentode, primarily intended for use in pre-amplifier stages

EF 37A

HEATER

V_h 6.3 V I_h 0.2 A Suitable for D.C./A.C. operation

CAPACITANCES

C_{a-g1}	< 0.02	$\mu\mu F$
C_{in}	5.5	$\mu\mu F$
C_{out}	8.5	$\mu\mu F$

CHARACTERISTICS

V_a	250	V
V_{g2}	100	V
V_{g3}	0	
I_a	3	mA
V_{g1}	-2	V
I_{g2}	0.8	mA
g_m	1.8	mA/V
r_a	2.5	M Ω
μ_{g1-g2}	28	

OPERATING CONDITIONS

As R.C. coupled A.F. amplifier connected as pentode

V_b (V)	R_a (K Ω)	I_k (mA)	R_{g2} (K Ω)	R_k (K Ω)	V_{out} $\overline{V_{in}}$	** V_{out} ($V_{r.m.s.}$)	* R_{g1} (K Ω)
400	100	3.4	330	1.2	115	80	330
350	100	2.9	330	1.2	112	69	330
300	100	2.5	330	1.2	108	59	330
250	100	2.1	330	1.2	103	49	330
200	100	1.7	330	1.2	98	39	330
400	220	1.8	680	2.2	180	81	680
350	220	1.6	680	2.2	176	69	680
300	220	1.3	680	2.2	170	58	680
250	220	1.1	680	2.2	163	48	680
200	220	0.9	680	2.2	152	37	680

* R_{g1} is the grid resistance of the following valve

** $D_{tot} = 5\%$



A VOLTAGE AMPLIFYING PENTODES

EF 37A OPERATING CONDITIONS

(contd.)

As R.C. coupled A.F. amplifier connected as triode with g_2 connected to a and g_3 connected to k

V_b (V)	R_a (K Ω)	I_a (mA)	R_k (K Ω)	$\frac{V_{out}}{V_{in}}$	V_{out}^\dagger ($V_{r.m.s.}$) (%)	D_{tot}^\dagger	R_{g1}^* (K Ω)
400	47	4.6	1.2	18.4	67	4.5	150
350	47	4.0	1.2	18.2	57	4.4	150
300	47	3.4	1.2	18.0	48	4.3	150
250	47	2.8	1.2	17.7	38	4.2	150
200	47	2.3	1.2	17.5	29	4.0	150
400	100	2.4	2.2	20.1	66	3.9	330
350	100	2.1	2.2	20.0	57	3.9	330
300	100	1.8	2.2	19.9	48	3.8	330
250	100	1.5	2.2	19.7	38	3.7	330
200	100	1.2	2.2	19.5	28	3.5	330
400	220	1.2	3.9	20.6	61	3.4	680
350	220	1.0	3.9	20.4	52	3.3	680
300	220	0.9	3.9	20.3	44	3.3	680
250	220	0.8	3.9	20.2	35	3.2	680
200	220	0.6	3.9	20.0	26	3.0	680

\dagger Output voltage and distortion at start of positive grid current. At lower output voltage the distortion is approximately proportional to the voltage.

* R_{g1} is the grid resistance of the following valve.

LIMITING VALUES

$V_{a(b)}$ max.	550	V
V_a max.	300	V
p_a max.	1	W
$V_{g2(b)}$ max.	550	V
V_{g2} max.	150	v
p_{g2} max.	0.3	W
I_k max.	6	mA
I_{g2} max.	1.4	mA
R_{g1-k} max. (self bias)	3	M Ω
R_{g1-k} max. (fixed bias)	1	M Ω
V_{h-k} max.	100	V



72

BASE:
Octal

DIMENSIONS:
L=100 mm
D=32 mm

VALVE DATA
PREFERRED TYPES **4**
VOLTAGE AMPLIFYING PENTODES **A**

H.F. pentode with variable-mu characteristics

EF 39

HEATER

V_h 6.3 V I_h 0.2 A Suitable for series or parallel operation

CAPACITANCES

C_{a-g1}	<0.003	$\mu\mu\text{F}$
C_{in}	5.5	$\mu\mu\text{F}$
C_{out}	7.2	$\mu\mu\text{F}$

OPERATING CONDITIONS

V_a	200	200	250	250	V
R_{g2}	68	68	82	82	K Ω
V_{g2}	100	100	100	100	V
V_{g3}	0	0	0	0	V
V_{g1}	-2.5	-39	-2.5	-49	V
I_a	6.0	—	6.0	—	mA
I_{g2}	1.7	—	1.7	—	mA
g_m	2.2	0.0055	2.2	0.0045	mA/V
r_a	0.9	>10	1.25	>10	M Ω
R_k	330	330	330	330	Ω

LIMITING VALUES

$V_{a(b)}$ max.	550	V
V_a max.	300	V
p_a max.	2	W
$V_{g2(b)}$ max.	550	V
V_{g2} max. ($I_a=6$ mA)	125	V
V_{g2} max. ($I_a=3$ mA)	300	V
p_{g2} max.	0.3	W
I_k max.	10	mA

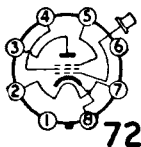

72

BASE:
Octal

DIMENSIONS:
L=100 mm
D=32 mm

Low microphony A.F. pentode

EF 40

HEATER

V_h 6.3 V I_h 0.2 A Suitable for series or parallel operation

CAPACITANCES

C_{in}	4.0	$\mu\mu\text{F}$
C_{out}	5.5	$\mu\mu\text{F}$
C_{a-g1}	0.025	$\mu\mu\text{F}$



4 VALVE DATA PREFERRED TYPES

A VOLTAGE AMPLIFYING PENTODES

EF 40
(contd.)

CHARACTERISTICS

V_a	250	V
V_{g2}	140	V
V_{g3}	0	V
V_{g1}	-2.0	V
I_a	3.0	mA
I_{g2}	0.55	mA
μ_{g1-g2}	38	
g_m	1.85	mA/V
r_a	2.5	M Ω

OPERATING CONDITIONS AS R.C. COUPLED A.F. AMPLIFIER

V_b	250	250	V
R_a	†0.1	†0.22	M Ω
R_{g2}	†0.39	†1.0	M Ω
R_k	†1,000	†2,200	Ω
* R_{g1}	330	680	K Ω
I_k	2.05	0.95	mA
$\frac{V_{out}}{V_{in}}$	112	180	

* Grid resistor of following valve.
† Values $\pm 10\%$

OPERATING CONDITIONS AS TRIODE CONNECTED R.C. COUPLED A.F. AMPLIFIER

V_b (V)	R_a (K Ω)	I_a (mA)	R_k (Ω)	$\frac{V_{out}}{V_{in}}$ (V)	$V_{out}\dagger$ (V)	$D_{tot}\dagger$ (%)	R_{g1} * (K Ω)
400	47	3.7	1,200	24.5	64	4.5	150
350	47	3.2	1,200	24.5	53	4.0	150
300	47	2.7	1,200	24.0	43	3.8	150
250	47	2.3	1,200	23.5	32	3.5	150
200	47	1.85	1,200	23.5	22	3.1	150
400	100	2.0	2,200	28.5	73	4.0	330
350	100	1.7	2,200	28.5	62	4.0	330
300	100	1.5	2,200	28.5	50	3.8	330
250	100	1.25	2,200	28.0	39	3.7	330
200	100	1.0	2,200	27.5	27.5	3.3	330
400	220	1.05	3,900	32.0	74	3.8	680
350	220	0.9	3,900	31.5	62	3.7	680
300	220	0.8	3,900	31.0	51	3.7	680
250	220	0.65	3,900	30.5	39	3.5	680
200	220	0.5	3,900	30.5	28	3.1	680

† Output voltage and distortion at the start of positive grid current. At lower output voltages the distortion is approximately proportional to the voltage.

* Grid resistor of the following valve.



LIMITING VALUES

$V_{a(b)}$ max.	550	V
V_a max.	300	V
p_a max.	1	W
$V_{g2(b)}$ max.	550	V
V_{g2} max.	200	V
p_{g2} max.	0.2	W
I_k max.	6	mA
R_{g1-k} max. ($p_a > 0.2$ W)	3	M Ω
R_{g1-k} max. ($p_a < 0.2$ W)	10	M Ω
V_{h-k} max.	50	V

EF 40
(contd.)



BASE:
B8A

DIMENSIONS:
L=60 mm
D=22 mm

H.F. pentode with variable-mu characteristics

EF 41

HEATER

V_h 6.3 V I_h 0.2 A Suitable for series or parallel operation

CAPACITANCES

C_{a-g1}	<0.002	$\mu\mu\text{F}$
C_{ta}	5	$\mu\mu\text{F}$
C_{out}	8	$\mu\mu\text{F}$

OPERATING CONDITIONS

As R.F. or I.F. amplifier

$V_a = V_b$	250	V
R_{g2}	82	K Ω
R_k	330	Ω
V_{g1}	-2.5	-39 V
I_a	6.0	mA
I_{g2}	1.7	mA
g_m	2,200	22 $\mu\text{A/V}$
r_a	1	>10 M Ω
μ_{g1-g2}	18	—
R_{eq}	6.5	K Ω

LIMITING VALUES

$V_{a(b)}$ max.	550	V
V_a max.	300	V
p_a max.	2	W
$V_{g2(b)}$ max.	550	V
V_{g2} max. ($I_a < 3$ mA)	300	V
V_{g2} max. ($I_a = 6$ mA)	125	V



4 VALVE DATA PREFERRED TYPES

A VOLTAGE AMPLIFYING PENTODES

EF 41 (contd.) LIMITING VALUES (contd.)



P_{g2} max.	0.3	W
I_k max.	10	mA
R_{g1-k} max.	3	M Ω
V_{h-k} max.	50	V

BASE:
B8A

DIMENSIONS:
L=60 mm
D=22 mm

EF 42 High slope H.F. pentode with sharp cut-off characteristics

HEATER

V_h 6.3 V I_h 0.33 A Suitable for A.C. mains operation

CAPACITANCES

C_{a-g1}	<0.005	$\mu\mu\text{F}$
C_{in}	9.5	$\mu\mu\text{F}$
C_{out}	4.5	$\mu\mu\text{F}$

OPERATING CONDITIONS

V_a	250	V
V_{g2}	250	V
V_{g1}	-2	V
I_a	10	mA
I_{g2}	2.3	mA
g_m	9.5	mA/V
r_a	0.44	M Ω
V_{g2} (for I_a cut-off)	-60	V
R_{eq}	750	Ω
Input Damping (at 50 Mc/s)	5	K Ω

LIMITING VALUES

$V_{a(b)}$ max.	550	V
V_a max.	300	V
P_a max.	2.5	W
$V_{g2(b)}$ max.	550	V
V_{g2} max.	300	V
P_{g2} max.	0.7	W
I_k max.	13	mA



BASE:
B8A

DIMENSIONS:
L=60 mm
D=22 mm

VALVE DATA
PREFERRED TYPES **4**

VOLTAGE AMPLIFYING PENTODES **A**

Short-wave R.F. pentode with sharp cut-off characteristics

EF 50

HEATER

V_h 6.3 V I_h 0.3 A Suitable for series or parallel operation

CAPACITANCES

Valve cold

C_{a-g1}	<0.007	$\mu\mu\text{F}$
C_{g1-g2}	2.4	$\mu\mu\text{F}$
C_{in}	8.3	$\mu\mu\text{F}$
C_{out}	5.2	$\mu\mu\text{F}$

OPERATING CONDITIONS

V_a	250	V
V_{g2}	250	V
V_{g1}	-2	V
V_{g3}	0	V
R_k	150	Ω
I_a	10	mA
I_{g2}	3	mA
g_m	6.5	mA/V
r_a	1	M Ω
μ_{g1-g2}	75	
R_{eq}	1,400	Ω
Input damping at 50 Mc/s	4	K Ω
V_{g3} ($I_m=0.45$ mA/V)	-54	V

LIMITING VALUES

$V_{a(b)}$ max.	550	V
V_a max.	300	V
p_a max.	3	W
I_k max.	15	mA
$V_{g2(b)}$ max.	550	V
V_{g2} max.	300	V
p_{g2} max.	1.7	W
R_{g1-k} max.	3	M Ω
V_{h-k} max.	100	V



BASE:
B9G

DIMENSIONS:
L=78 mm
D=38 mm

V.H.F. pentode with sharp cut-off characteristics

EF 54

HEATER

V_h 6.3 V I_h 0.3 A Suitable for series or parallel operation

CAPACITANCES

C_{a-g1}	<0.02	$\mu\mu\text{F}$
C_{g1-g2}	2.2	$\mu\mu\text{F}$
C_{in}	6.2	$\mu\mu\text{F}$
C_{out}	4.9	$\mu\mu\text{F}$



4 VALVE DATA PREFERRED TYPES

A VOLTAGE AMPLIFYING PENTODES

EF 54 (contd.)

OPERATING CONDITIONS

V_a	250	V
V_{g2}	250	V
V_{g1}	-1.7	V
R_k	150	Ω
I_a	10	mA
I_{g2}	1.45	mA
g_m	7.7	mA/V
r_a	0.5	M Ω
μ_{g1-g2}	80	
R_{eq}	700	Ω
Input damping (50 Mc/s)	10,000	Ω

LIMITING VALUES

$V_{a(b)}$ max.	550	V
V_a max.	300	V
p_a max.	3	W
$V_{g2(b)}$ max.	550	V
V_{g2} max.	300	V
p_{g2} max.	1.7	W
I_k max.	15	mA
V_{h-k} max.	100	V
Max. operating frequency	250	Mc/s



BASE:
B9G

DIMENSIONS:
L=78 mm
D=38 mm

EF 55

Video pentode with sharp cut-off characteristics

HEATER

V_h 6.3 V I_h 1.0 A

CAPACITANCES

C_{in}	15	$\mu\mu F$
C_{out}	12	$\mu\mu F$
C_{a-g1}	0.15	$\mu\mu F$

OPERATING CONDITIONS

V_a	250	250	V
V_{g2}	250	150	V
V_{g1}	-4.5	-4.0	V
I_a	40	10	mA
I_{g2}	5.5	1.0	mA
R_k	100	390	Ω
g_m	12	7	mA/V
μ_{g1-g2}	28	27	
r_a	55	100	K Ω



VOLTAGE AMPLIFYING PENTODES A

LIMITING VALUES

$V_{a(b)}$, max.	500	V
V_a max.	300	V
$V_{g2(b)}$, max.	300	V
V_{g2} max.	250	V
p_a max.	10	W
p_{g2} max.	2	W
$i_{k(pk)}$ max. with 50 μ sec. 500 c/s pulse	1.5	A
V_{h-k} max.	150	V
R_{g1-k} max.	0.7	M Ω

EF 55
(contd.)



BASE:
B9G

DIMENSIONS:
L=100 mm
D=38 mm

H.F. pentode for use as amplifier or mixer in television receivers

EF 80

HEATER

V_h 6.3 V I_h 0.3 A Suitable for series or parallel operation

CAPACITANCES

C_{in}	7.5	$\mu\mu F$
C_{out}	3.3	$\mu\mu F$
C_{a-g1} (approx.)	<0.007	$\mu\mu F$
C_{a-k} (approx.)	<0.03	$\mu\mu F$

CHARACTERISTICS

V_a	170	V
V_{g2}	170	V
V_{g1}	0	V
I_a	10	mA
I_{g2}	2.5	mA
V_{g1}	-2.0	V
g_m	7.4	mA/V
r_a	0.4	M Ω
μ_{g1-g2}	50	
R_{eq}	1,000	Ω
Input damping at 50 Mc/s	12	K Ω

LIMITING VALUES

$V_{a(b)}$, max.	550	V
V_a max.	250	V
p_a max.	2.5	W
$V_{g2(b)}$, max.	550	V
V_{g2} max.	250	V
p_{g2} max.	0.65	W
I_k max.	15	mA
R_{g1-k} max.	1.0	M Ω
V_{h-k} max.	150	V



BASE:
B9A
(Noval)

DIMENSIONS:
L=67 mm
D=22.2 mm



4 VALVE DATA PREFERRED TYPES

A VOLTAGE AMPLIFYING PENTODES

EF 91 Miniature H.F. pentode with sharp cut-off characteristics

HEATER

V_h 6.3 V I_h 0.3 A Suitable for series or parallel operation

CAPACITANCES

C_{a-g1}	< 0.008	$\mu\mu\text{F}$
C_{in}	7.0	$\mu\mu\text{F}$
C_{out}	2.0	$\mu\mu\text{F}$

OPERATING CONDITIONS

As R.F. amplifier

V_a	250	V
V_{g2}	250	V
V_{g3}	0	V
V_{g1}	-2.0	V
I_a	10	mA
I_{g2}	2.5	mA
g_m	7.6	mA/V
r_a	1.0	M Ω
μ_{g1-g3}	70	
R_{eq}	1,200	Ω
Input Damping (at 50 Mc/s)	7,500	Ω

OPERATING CONDITIONS

As Mixer at 45 Mc/s (See Fig. 1, page 35)

V_b	250	V
R_k	470	Ω
I_a ($V_{osc} = 0$ V)	4.4	mA
I_a ($V_{osc} = 2.25$ V)	5.5	mA
I_{g1}	0.5	μA
g_c	2.5	mA/V
R_{g1-k}	1.0	M Ω
R_{eq}	6.5	K Ω

LIMITING VALUES

$V_{a(b)}$ max.	550	V
V_a max.	300	V
p_a max.	2.5	W
$V_{g2(b)}$ max.	550	V
V_{g2} max.	300	V
p_{g2} max.	0.65	W
I_k max.	15	mA
R_{g1-k} max.	1.0	M Ω
V_{h-k} max.	150	V



74

BASE:
B7G

DIMENSIONS:
L=54 mm
D=19 mm

VOLTAGE AMPLIFYING PENTODES

Fig. 1.

A.C. Mains-operated Frequency Changer using two EF91 Pentodes, one as Mixer and one as Oscillator

1. The first I.F. circuit consists of L2, C2 and R2, L2 being designed to resonate at 13 Mc/s
2. The Oscillator circuit, formed by L3 and C7 resonates at 32 Mc/s
3. To obtain maximum oscillator voltage it should be adjusted until the mixer anode current reaches its maximum value.

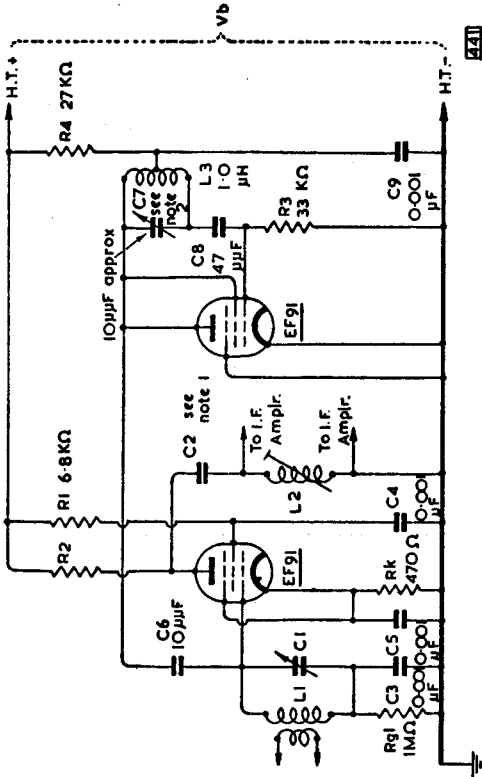

4 VALVE DATA PREFERRED TYPES

A VOLTAGE AMPLIFYING PENTODES

EF 92 Miniature H.F. pentode with variable-mu characteristics

HEATER

V_h 6.3 V I_h 0.2 A Suitable for series or parallel operation

CAPACITANCES

Measured with close fitting metal can and shielded socket

C_{a-g1}	0.004	$\mu\mu\text{F}$
C_{in}	4.5	$\mu\mu\text{F}$
C_{out}	7.0	$\mu\mu\text{F}$

CHARACTERISTICS

V_a	250	250	
V_{g2}	150	200	V
V_{g3}	0	0	V
I_a	8.0	8.0	mA
I_{g3}	2.0	2.1	mA
V_{g1}	-0.65	-2.5	V
g_m	2.5	2.5	mA/V
μ_{g1-g2}	30	30	
r_a	0.5	0.5	M Ω
$*V_{g1}$	-11	-21	V

*For 100 : 1 reduction in mutual conductance.

LIMITING VALUES

$V_{a(b)}$ max.	300	V
V_a max.	250	V
p_a max.	2.5	W
$V_{g2(b)}$ max.	300	V
V_{g2} max.	250	V
p_{g3} max.	0.6	W
I_k max.	12	mA
R_{g1-k} max.	3	M Ω
V_{h-k} max.	100	V



74

BASE:
B7G

DIMENSIONS:

L=54 mm

D=19 mm

KF 35 H.F. pentode with variable-mu characteristics

HEATER

V_f 2.0 V I_f 0.05 A Suitable for D.C. operation only

CAPACITANCES

C_{a-g1}	<0.01	$\mu\mu\text{F}$
C_{in}	8.0	$\mu\mu\text{F}$
C_{out}	10.0	$\mu\mu\text{F}$

VOLTAGE AMPLIFYING PENTODES **A**

OPERATING CONDITIONS

V_a	120			120			V
V_{g2}	60			120			V
V_{g1}	-1.5	-2.0	-9.5	-3.0	-5.5	-17.0	V
g_m	1,080	800	10	1,500	600	10	$\mu A/V$
I_a	1.45	1.0	—	3.8	1.1	—	mA
I_{g2}	0.5	0.35	—	1.0	0.4	—	mA

KF 35
(contd.)

LIMITING VALUES

V_a max.	150 V	V_{g2} max.	150 V
------------	-------	---------------	-------

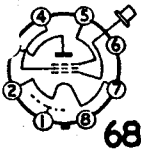

BASE:
Octal

DIMENSIONS:
L=110 mm
D=33 mm

R.F. single diode pentode with variable-mu characteristics **UAF 42**

HEATER

V_h 12.6 V I_h 0.1 A Suitable for series operation, A.C. or D.C.

CAPACITANCES

Pentode Section

C_{a-g1}	<0.002	$\mu\mu F$
C_{out}	5.0	$\mu\mu F$
C_{in}	4.5	$\mu\mu F$

Diode section

C_{a-d-k}	3.8	$\mu\mu F$
C_{a-d-g1}	<0.0015	$\mu\mu F$
C_{a-d-h}	<0.15	$\mu\mu F$

OPERATING CONDITIONS as R.F. or I.F. Amplifier

V_b	100	170	200	V
R_{g2}	56	56	76	K Ω
V_{g2}	50	85	85	V
R_k	310	310	310	Ω
V_{g1}	-1.2	-2.0	-2.0	V
I_a	2.8	5.0	5.0	mA
I_{g2}	0.9	1.5	1.5	mA
g_m	1.7	2.0	2.0	mA/V
r_a	0.85	0.9	1.0	M Ω
μ_{g1-g2}	18	18	18	
* V_{g1}	-16	-28	-34	V
R_{eq}	5.8	7.5	7.5	K Ω

*For 100 : 1 reduction in mutual conductance



4 VALVE DATA PREFERRED TYPES

A VOLTAGE AMPLIFYING PENTODES

UAF 42 (contd.)

LIMITING VALUES Pentode Section

$V_{a(b)}$ max.	550	V
V_a max.	250	V
p_a max.	2	W
$V_{g2(b)}$ max.	550	V
V_{g2} max. ($I_a < 2.5$ mA)	250	V
V_{g2} max. ($I_a = 5.0$ mA)	150	V
p_{g2} max.	0.3	W
I_k max.	10	mA
* R_{g2-k} max.	3.0	M Ω
R_{g1-k} max.	3.0	M Ω
V_{h-k} max.	150	V

*For $V_{g2(pk)}$ not exceeding +10 V

Diode Section



V_{ad} (pk) max.	200	V
I_{ad} max.	0.8	mA
V_{ad} max. ($I_{ad} = +0.3$ μ A)	-1.3	V
V_{h-k} max.	150	V

BASE:
B8A

DIMENSIONS:
L=60 mm
D=22 mm

UBF 80

Double diode variable- μ H.F. or A.F. pentode

Preliminary
Data

HEATER

V_h 17V I_h 0.1 A Suitable for series operation, A.C. or D.C.

CAPACITANCES

	$C_{a'd-g1}$	<0.0008	$\mu\mu$ F
	$C_{a''d-g1}$	<0.001	$\mu\mu$ F
	$C_{a'd-a}$	<0.2	$\mu\mu$ F
	$C_{a''d-a}$	<0.05	$\mu\mu$ F
Pentode Section	C_{a-g1}	<0.0025	$\mu\mu$ F
	C_{out}	4.6	$\mu\mu$ F
	C_{in}	4.0	$\mu\mu$ F
	C_{g1-h}	<0.07	$\mu\mu$ F
Diode Sections	$C_{a'd-k}$	2.15	$\mu\mu$ F
	$C_{a''d-k}$	2.35	$\mu\mu$ F
	$C_{a'd-a''d}$	<0.3	$\mu\mu$ F

OPERATING CONDITIONS as H.F. Amplifier

$V_a = V_b$	100	170	200	V
R_{g2}	47	47	68	K Ω
V_{g2}	0	0	0	V
I_a	2.8	5.0	5.0	mA
I_{g2}	1.0	1.75	1.75	mA
V_{g1}	-1.2	-2.0	-2.0	V
R_k	300	300	300	Ω
g_m	1.9	2.2	2.2	mA/V
r_a	0.9	0.9	1.0	M Ω
μ_{g1-g2}	18	18	18	
R_{eq}	4.6	6.2	6.2	K Ω
V_{g1} (for 100 : 1 reduction in g_m)	-15.5	-26.5	-31.5	V



UBF 80
(contd.)

OPERATING CONDITIONS

As R.C. coupled A.F. amplifier

V_b	100	100	170	170	V
R_a	0.22	0.1	0.22	0.1	M Ω
I_a	0.32	0.73	0.56	1.25	mA
R_{g2}	0.68	0.27	0.68	0.27	M Ω
I_{g2}	0.12	0.29	0.2	0.5	mA
R_k	2.7	1.0	2.7	1.0	K Ω
R_{g1}	1.0	1.0	1.0	1.0	M Ω
V_{out}/V_{in}	82	67	85	70	
** D_{tot}	1.9	1.8	1.5	1.6	%
* R_{g1}	0.68	0.33	0.68	0.33	M Ω

*Grid resistor of following valve. ** $V_{out}=5 V_{r.m.s.}$

LIMITING VALUES

Pentode Section	$V_{a(rb)}$ max.	550	V
	V_a max.	250	V
	p_a max.	1.5	W
	$V_{g2(rb)}$ max.	550	V
	V_{g2} max. ($I_a < 2$ mA)	250	V
	V_{g2} max. ($I_a = 5$ mA)	125	V
	p_{g2} max.	0.3	W
	I_k max.	10	mA
	R_{g1-k} max.	3	M Ω
	V_{h-k} max.	150	V
Diode Section	$V_{ad(pk)}$ max.	200	V
	I_{ad} max.	0.8	mA

BASE:
B9A
(Noval)

DIMENSIONS:
L=67 mm
D=22.2 mm



103

H.F. pentode with variable-mu characteristics

UF 41

HEATER

V_h 12.6 V I_h 0.1 A Suitable for series operation, A.C. or D.C.

CAPACITANCES

C_{a-g1}	<0.002	$\mu\mu F$
C_{out}	8.0	$\mu\mu F$
C_{in}	4.7	$\mu\mu F$

OPERATING CONDITIONS

As R.F. amplifier

$V_a = V_b$	100	170	V
R_{g2}	39	39	K Ω
R_k	330	330	Ω
V_{g1}	-1.4	-2.5	-28 V
I_a	3.3	6.0	mA
I_{g2}	1.0	1.75	mA
g_m	1,800	2,100	21 $\mu A/V$
r_a	0.8	1	>10 M Ω
μ_{g1-g2}	18	18	—
R_{eq}	6.0	8.0	— K Ω



4 VALVE DATA PREFERRED TYPES

A VOLTAGE AMPLIFYING PENTODES

UF 41 (contd.)

OPERATING CONDITIONS

As R.F. amplifier (contd.)

$V_a = V_b$	200	V
R_{g2}	39	K Ω
R_k	330	Ω
V_{g1}	-3	-34 V
I_a	7.2	— mA
I_{g2}	2.1	— mA
g_m	2,200	22 $\mu A/V$
r_a	1	>10 M Ω
μ_{g1-g2}	18	—
R_{eq}	8.8	— K Ω

OPERATING CONDITIONS

As A.F. amplifier

V_b	170	170	100	100	V
R_a	0.2	0.1	0.2	0.1	M Ω
R_{g2}	0.73	0.35	0.73	0.35	M Ω
R_k	2,500	1,300	2,500	1,300	Ω
I_a	0.62	1.16	0.36	0.7	mA
I_{g2}	0.2	0.38	0.12	0.22	mA
V_{out}/V_{in}	84	76	80	75	
$V_{out(r,m,s.)}$	8	8	5	5	V
$V_{in(r,m,s.)}$	0.094	0.105	0.063	0.067	V
D_{tot}	1.7	2.0	1.3	1.4	%

LIMITING VALUES

$V_{a(b)}$ max.	550	V
V_a max.	250	V
p_a max.	2	W
$V_{g2(b)}$ max.	550	V
V_{g2} max. ($I_a < 4$ mA)	250	V
V_{g2} max. ($I_a = 7.2$ mA)	150	V
p_{g2} max.	0.3	W
I_k max.	10	mA
R_{g1-k} max.	3	M Ω
V_{b-k} max.	150	V



BASE:
B8A

DIMENSIONS:
L=60 mm
D=22 mm

VALVE DATA
PREFERRED TYPES **4**
VOLTAGE AMPLIFYING PENTODES **A**

High slope R.F. pentode

UF 42

HEATER

V_h 21 V I_h 0.1 A Suitable for series operation, A.C. or D.C.

CAPACITANCES

C_{a-g1}	< 0.005	$\mu\mu\text{F}$
C_{1a}	9.5	$\mu\mu\text{F}$
C_{out}	4.5	$\mu\mu\text{F}$

OPERATING CONDITIONS

$V_a = V_{g2}$	170	V
I_a	10	mA
V_{g1}	-2	V
I_{g2}	2.8	mA
R_k	750	Ω
g_m	8.5	mA/V
r_s	0.2	M Ω
V_{g3} ($I_a = 10\mu\text{A}$)	-48	V approx.

LIMITING VALUES

$V_{a(b)}$ max.	550	V
V_a max.	300	V
$V_{g2(b)}$ max.	550	V
V_{g3} max.	300	V
p_a max.	2.5	W
p_{g2} max.	0.7	W
I_k max.	13	mA
R_{g1-k} max.	1.0	M Ω
V_{h-k} max.	150	V



BASE:
B8A

DIMENSIONS:
L=60 mm
D=22 mm



FREQUENCY CHANGERS

BATTERY

Type	Description	V_f	Base	Page
DK32	Heptode	1.4	Octal	44
DK91	Miniature Heptode	1.4	B7G	45
KCF30	Triode pentode	2.0	Octal	52
KK32	Octode	2.0	Octal	53

A.C. MAINS

Type	Description	V_h	Base	Page
EAC91	Miniature diode triode	6.3	B7G	45
ECH21	Triode heptode	6.3	Loctal (B8G)	46
†ECH35	Triode hexode	6.3	Octal	48
ECH42	Miniature triode hexode	6.3	B8A	49
*EK32	Octode	6.3	Octal	51

Note—Type EF91 H.F. pentode may also be used as frequency changer. For data and circuit see Section A, pages 34 and 35.

D.C./A.C. MAINS

Type	Description	I_h	Base	Page
CCH35	Triode hexode	0.2 A	Octal	44
UCH21	Triode heptode	0.1 A	Loctal (B8G)	54
UCH42	Miniature triode hexode	0.1 A	B8A	55

*This valve has a heater rated at 0.2 A and suitable for either parallel or series operation.

†This valve has a heater rated at 0.3 A and suitable for either parallel or series operation.



4 VALVE DATA PREFERRED TYPES

B FREQUENCY CHANGERS

CCH 35 Triode hexode with variable-mu characteristics

HEATER

V_h 7.0 V I_h 0.2 A Suitable for series or parallel operation

For operating data see Type ECH35, page 48. Except for the heater voltage and current, the ECH35 and the CCH35 are identical

DK 32 Heptode with variable-mu characteristics

FILAMENT

V_f 1.4 V I_f 0.05 A Suitable for D.C. operation only

CAPACITANCES

C_{a-g4}	< 0.5 $\mu\mu\text{F}$	C_{g4-all}	7.0 $\mu\mu\text{F}$
C_{out}	10.0 $\mu\mu\text{F}$	C_{g1-g4}	< 0.2 $\mu\mu\text{F}$

OPERATING CONDITIONS

(See Fig. 2, page 56)

V_a	90	90	V
V_{g3+g5}	45	45	V
V_{g2}	90	90	V
V_{g4}	0	-3	V
I_a	0.6	—	mA
I_{g3+g5}	0.7	—	mA
I_{g2}	1.2	—	mA
I_{g1}	35	—	μA
I_k	2.5	—	mA
R_{g1}	200	200	K Ω
r_a	0.6	—	M Ω
g_o	250	5	$\mu\text{A/V}$

Characteristics of Oscillator Section ($V_{out} = 0$)

V_a	90	V
V_{g3+g5}	45	V
V_{g4}	0	V
V_{g2}	90	V
V_{g1}	0	V
g_m	550	$\mu\text{A/V}$

LIMITING VALUES

V_a max.	110	V
$V_{g3+g5(b)}$ max.	110	V
V_{g3+g5} max.	60	V
V_{g2} max.	110	V
I_k max.	4	mA
$R_{g4-f.}$ min.	1	M Ω

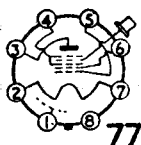

BASE:
Octal

DIMENSIONS:
L=102 mm
D=30 mm

Miniature heptode with variable-mu characteristics

DK 91

FILAMENT

V_f 1.4 V I_f 0.05 A Suitable for D.C. operation only

CAPACITANCES

C_{g2-all}	7.0 $\mu\mu F$
C_{a-all}	7.5 $\mu\mu F$
C_{g1-all}	3.8 $\mu\mu F$

OPERATING CONDITIONS

(See Figs. 3 and 4, pages 56 and 57)

V_a	45	67.5	90	90	V
V_{g3+g4}	45	67.5	45	67.5	V
V_{g3}	0	0	0	0	V
R_{g1}	0.1	0.1	0.1	0.1	M Ω
r_a	0.6	0.5	0.8	0.6	M Ω
g_o	235	280	250	300	$\mu A/V$
$V_{g3} (g_o=5 \mu A/V)$	-9	-14	-9	-14	V
I_a	0.7	1.4	0.8	1.6	mA
I_{g3+g4}	1.9	3.2	1.9	3.2	mA
I_{g1}	150	250	150	250	μA
I_k	2.75	5.0	2.75	5.0	mA

Characteristics of Oscillator Section

$V_{g1}=V_{g2}$	0	V
$V_{g3}=V_{g4}=V_a$	67.5	V
$g_m(g1-g3+g4+a)$	1.4	mA/V

LIMITING VALUES

V_a max.	90	V
V_{g3+g4} (b) max.	90	V
V_{g3+g4} max.	67.5	V
V_{g3} max.	0	V
I_k max.	5.5	mA

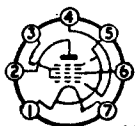

41

BASE:
B7G

DIMENSIONS:
L=54 mm
D=19 mm

Miniature diode triode. Primarily designed for use as a frequency changer up to 300 Mc/s. The triode section may also be used as a voltage amplifier.

EAC 91

HEATER

V_h 6.3 V I_h 0.3 A Suitable for series or parallel operation

CAPACITANCES

C_{g-k}	1.7 $\mu\mu F$	C_{at-nd}	0.4 $\mu\mu F$
C_{a-k}	0.4 $\mu\mu F$	C_{ad-kd}	1.5 $\mu\mu F$
C_{at-g}	1.6 $\mu\mu F$	C_{kt-kd}	0.4 $\mu\mu F$
C_{g-nd}	<0.1 $\mu\mu F$		



4 VALVE DATA PREFERRED TYPES

B FREQUENCY CHANGERS

EAC 9J CHARACTERISTICS

(contd.)

Triode Section	V_a	200	V
	I_a	7.5	mA
	V_g	-2.8	V
	g_m	2.8	mA/V
	μ	36	
	r_a	12.8	K Ω

OPERATING CONDITIONS

For circuit see Fig. 6, page 57

Coil data :	L1	Turns	3.5
		Coil diameter	10 mm.
		Coil length	7 mm
		Diameter of wire	1 mm
	L2	Dust cored, to tune to intermediate frequency	
	L3	} Dependent upon signal frequency	
	L4		

LIMITING VALUES

Triode Section :	V_a max.	250	V
	p_a max.	2	W
	I_k max.	10	mA
	V_{h-k} max.	50	V
Diode Section :	V_a max.	50	V
	I_a max.	5	mA
	Max. operating frequency as frequency changer	300	Mc/s
	Limiting frequency of oscillation	600	Mc/s



BASE :
B7G

DIMENSIONS :

L=54 mm

D=19 mm

ECH 2J Triode heptode with variable-mu characteristics

HEATER

V_h 6.3 V I_h 0.33 A Suitable for A.C. operation only

CAPACITANCES

Heptode Section			Triode Section	
C_{in}	6.8	$\mu\mu F$	C_{g-k}	3.2 $\mu\mu F$
C_{out}	9.5	$\mu\mu F$	C_{a-k}	2.0 $\mu\mu F$
C_{a-g1}	<0.002	$\mu\mu F$	C_{a-g}	1.1 $\mu\mu F$
C_{g2-all}	8.0	$\mu\mu F$		



OPERATING CONDITIONS as frequency changer

ECH 21
(contd.)

Heptode Section as Mixer (See Fig. 5, Page 57)

$V_a = V_b$	250	250	V
R_{g2+g4}	22	22	K Ω
R_k	150	150	Ω
R_{g3-gt}	47	47	K Ω
I_{g2+g4}	190	190	μA
V_{g1}	-2	-24.5	V
V_{g2+g4}	100	250	V
I_a	3	—	mA
I_{g2+g4}	6.2	—	mA
r_a	1.4	>3.0	M Ω
g_o	750	7.5	$\mu A/V$
R_{eq}	55	—	K Ω

Triode Section as R.F. oscillator

V_b	250	V
R_{at}	22	K Ω
R_{g3-gt}	47	K Ω
I_{gt+g3}	190	μA
I_a	4.5	mA
g_m (effective)	0.55	mA/V

Characteristics of Triode Section

V_a	100	V
V_g	0	V
I_a	12	mA
g_m	3.2	mA/V
μ	21	

For application as phase inverter and as combined I.F. and A.F. amplifier see Figs. 9, 10 and 11, page 59.

LIMITING VALUES

Heptode Section

$V_{a(b)}$ max.	550	V
V_a max.	300	V
p_a max.	1.5	W
$V_{g2+g4(b)}$ max.	550	V
V_{g2+g4} ($I_a = 3$ mA)	100	V
V_{g2+g4} ($I_a < 1$ mA)	300	V
P_{g2+g4} max.	1	W
I_k max.	15	mA
R_{g1-k} max.	3	M Ω

Triode Section

$V_{a(b)}$ max.	550	V
V_a max.	175	V
p_a max.	0.8	W
V_g max. ($I_g = +0.3$ μA)	-1.3	V
R_{g-k} max.	3.0	M Ω

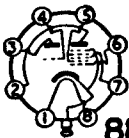

88

BASE :
B8G

DIMENSIONS :
L=77 mm
D=32 mm



4 VALVE DATA PREFERRED TYPES

B FREQUENCY CHANGERS

ECH 35 Triode hexode with variable-mu characteristics

HEATER

V_h 6.3 V I_h 0.3 A Suitable for series or parallel operation

CAPACITANCES

Hexode Section		Triode Section	
C_{in}	5.0 $\mu\mu\text{F}$	C_{g-k}	9.0 $\mu\mu\text{F}$
C_{out}	10.0 $\mu\mu\text{F}$	C_{a-k}	3.0 $\mu\mu\text{F}$
C_{a-g1}	< 0.003 $\mu\mu\text{F}$	C_{a-g1}	1.6 $\mu\mu\text{F}$

OPERATING CONDITIONS

Hexode Section

(a) With Fixed Screen Voltage

V_b	250	V
V_{g2+g4}	100	V
R_k	220	$\text{K}\Omega$
R_{g2-k}	47	$\text{K}\Omega$
I_{g3}	200	μA
V_{g1}	-2	-17
I_a	3	—
I_{g2+g4}	3	—
g_o	650	6.5
r_a	1.3	> 5.0

(b) With screen grid fed from a potentiometer (Fig. 7, page 58)

$V_a = V_b$	250	V
R_1	22	$\text{K}\Omega$
R_2	33	$\text{K}\Omega$
R_k	220	Ω
R_{g1}	47	$\text{K}\Omega$
I_{g3}	200	μA
V_{g1}	-2	-23.5
V_{g2+g4}	100	—
I_a	3	—
I_{g2+g4}	3	—
g_o	650	6.5
r_a	1.3	> 3.0

Triode Section (C = 50 $\mu\mu\text{F}$, Fig. 7, page 58)

V_b	100	250	V
R_{at}	—	47	$\text{K}\Omega$
I_a ($R_{gt}=47 \text{ K}\Omega$, $I_{gt}=200 \mu\text{A}$)	3.3	3.3	mA
I_a ($V_{gt}=0$ $V_{os0}=0$)	10.0	4.5	mA
g_m ($V_{gt}=0$ $V_{os0}=0$)	2.8	2.2	mA/V
μ ($V_{gt}=0$ $V_{os0}=0$)	24	24	



LIMITING VALUES

ECH 35
(contd.)

Hexode Section

$V_{a(b)}$ max.	550	V
V_a max.	300	V
p_a max.	1.2	W
$V_{g2+g4(b)}$ max.	550	V
V_{g2+g4} ($I_a=4.5$ mA)	125	V
V_{g2+g4} ($I_a<0.5$ mA)	200	V
p_{g2+g4} max.	0.6	W
I_k max.	15	mA
R_{g1-k} max.	3	M Ω
V_{h-k} max.	100	V

Triode Section

$V_{a(b)}$ max.	550	V
V_a max.	100	V
p_a max.	1.5	W
V_{gt} max. ($I_{gt}=+0.3$ μ A)	-1.3	V
R_{gt-k} max.	100	K Ω



BASE :
Octal

DIMENSIONS :
L=113 mm
D=36 mm

82

Triode hexode with variable-mu characteristics

ECH 42

HEATER

V_b 6.3 V I_b 0.23 A Suitable for A.C. operation

CAPACITANCES

Hexode Section

C_{gt-ah}	<0.2 μ F	$C_{g1-h+k+g2+g4+skirt}$	4.0	μ F
C_{g1h-gt}	<0.35 μ F	$C_{a-h+k+g2+g4+skirt}$	9.2	μ F
		C_{a-g1}	<0.1	μ F

Triode Section

$C_{gt-h+k+g2+g4+skirt}$	5.5	μ F
$C_{a-h+k+g2+g4+skirt}$	2.3	μ F
C_{a-gt}	1.2	μ F

OPERATING CONDITIONS

For circuits see Fig. 7, page 58

Hexode Section

$V_a=V_b$	250	V
R_1	27	K Ω
R_2	27	K Ω
R_k	180	Ω
R_{g2+gt}	47	K Ω
I_{g2+gt}	200	μ A
V_{g1}	-2.0	V
I_a	3.0	mA
I_{g2+g4}	3.0	mA
V_{g2+g4}	85	V
g_o	750	μ A/V
r_a	1.0	M Ω
R_{eq}	75	K Ω
V_{g1} (for 100 : 1 reduction in gm)	-29	V



4 VALVE DATA PREFERRED TYPES

B FREQUENCY CHANGERS

ECH 42 (contd.)

Triode Section			
V_b	250	V	
R_a	33	K Ω	
I_a	4.8	mA	
R_{g1-g2}	47	K Ω	
I_{g1-g2}	200	μA	

The effective mutual conductance under the above conditions is approximately 0.55 mA/V

CHARACTERISTICS

Triode Section			
V_a	100	V	
V_{g1}	0	V	
I_a	10	mA	
g_m	2.8	mA/V	
μ	22		

LIMITING VALUES

Hexode Section			
$V_{a,(b)}$ max.	550	V	
V_a max.	250	V	
p_a max.	1.5	W	
$V_{g2+g3(b)}$ max.	550	V	
V_{g2+g4} max.	125	V	
p_{g2+g4} max.	0.3	W	
I_k max.	7.0	mA	
R_{g1-k} max.	3.0	M Ω	
R_{g2-k} max.	3.0	M Ω	
V_{h-k} max.	50	V	

Triode Section			
$V_{a,(b)}$ max.	550	V	
V_a max.	175	V	
p_a max.	0.8	W	
I_k max.	6.0	mA	
V_g max. ($I_g = +0.3 \mu A$)	-1.3	V	
R_{g1-k} max.	3.0	M Ω	



BASE :
B8A

DIMENSIONS :
L=60 mm
D=22 mm



**Octode with variable-mu characteristics
 HEATER**

EK 32

V_h 6.3 V I_h 0.2 A Suitable for series or parallel operation

CAPACITANCES

C_{1a}	9.0 $\mu\mu\text{F}$	C_{a-g4}	<0.1 $\mu\mu\text{F}$
C_{out}	10.5 $\mu\mu\text{F}$	C_{g1-a11}	6.0 $\mu\mu\text{F}$
		C_{g3-a11}	5.0 $\mu\mu\text{F}$

OPERATING CONDITIONS

(See Fig. 8, page 58)

	Medium and Long Wave	Short Wave	
V_a	250	250	V
V_{g2}	200	200	V
V_{g3+g5}	50	80	V
V_{g4}	-2	-4	V
R_1	22	22	K Ω
R_2	6.8	15	K Ω
R_k	470	430	Ω
R_{g1-k}	47	15	K Ω
R_{g2}	22	10	K Ω
V_{0+0} (r.m.s.)	15	5	9 V
I_{g1}	300	275	200 μA
I_a	1.0	2.3	1.7 mA
I_a ($V_{g4}=-25\text{V}$)	<0.015		mA
I_{g2}	2.5	5.3	4.0 mA
I_{g3+g5}	0.8	1.9	1.3 mA
g_c	0.55	0.65	0.5 mA/V
g_o ($V_{g4}=-25\text{V}$)	<0.002		mA/V
r_a	2.0	0.9	1.4 M Ω
r_a ($V_{g4}=-25\text{V}$)	>10		M Ω

LIMITING VALUES

$V_{a(b)}$ max.	550	V	p_{g3+g5} max.	0.3	W
V_a max.	250	V	$V_{r2(b)}$ max.	550	V
p_a max.	1.0	W	V_{g2} max.	225	V
$V_{g3+g5(b)}$ max.	550	V	p_{g2} max.	1.3	W
V_{g3+g5} max.	125	V	I_k max.	12	mA

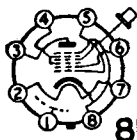

BASE :
Octal

DIMENSIONS :
L=100 mm
D=63 mm



4 VALVE DATA PREFERRED TYPES

B FREQUENCY CHANGERS

KCF 30 Triode pentode with variable-mu characteristics

FILAMENT

V_f 2.0 V I_f 0.2 A Suitable for D.C. operation only

CAPACITANCES

Pentode Section		Triode Section	
C_{a-all}	8.0 $\mu\mu\text{F}$	C_{a-all} (less C_{gt-at})	3.75 $\mu\mu\text{F}$
C_{g-all}	6.5 $\mu\mu\text{F}$	C_{g-all} (less C_{gt-at})	9.0 $\mu\mu\text{F}$
C_{a-gt}	0.01 $\mu\mu\text{F}$	C_{a-g}	2.0 $\mu\mu\text{F}$

OPERATING CONDITIONS (with g_s injection)

V_a	100	120	120	V
V_{g2}	60	60	40	V
V_{g1}	-1.5	-1.5	-0.3	V
I_a	0.53	0.53	0.55	mA
I_{g2}	0.97	0.97	0.95	mA
g_c	250	260	285	$\mu\text{A/V}$
$V_{os0(pk)}$ min.	8.0	8.0	8.0	V
V_{g1} ($g_c = 10 \mu\text{A/V}$)	-12.5	-14.0	-14.0	V
* R_{gt-f}	47	47	47	K Ω

*Grid leak returned to f+

CHARACTERISTICS

Triode Section

V_a	100	V
V_{g1}	0	V
g_m	1.7	mA/V
μ	18	

LIMITING VALUES

Pentode Section		Triode Section	
V_a max.	150 V	V_a max.	150 V
V_{g2} max.	150 V	I_a (pk) max.	15 mA

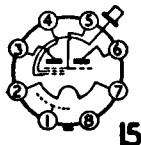

BASE :
Octal

DIMENSIONS :
L=110 mm
D=33 mm

Octode with variable-mu characteristics

KK 32

FILAMENT

V_f 2.0 V I_f 0.13 A Suitable for D.C. operation only

CAPACITANCES

C_{g1-all}	6.3	$\mu\mu F$
C_{g2-all}	8.5	$\mu\mu F$
C_{g4-all}	9.0	$\mu\mu F$
C_{out}	11.0	$\mu\mu F$

OPERATING CONDITIONS

Medium and Long Wave working

V_a	90	135	V
V_{g2}	90	135	V
V_{g3+g5}	45	45	V
V_{osc} (r.m.s.) approx.	8.5	8.5	V
I_a ($V_{g4} = -0.5$ V)	0.7	0.7	mA
I_a ($V_{g4} = -12$ V)	<0.015	0.015	mA
I_{g2}	1.3	2.1	mA
I_{g3+g5}	0.6	0.7	mA
g_c ($V_{g4} = -0.5$ V)	270	270	$\mu A/V$
g_c ($V_{g4} = -12$ V)	<2	2	$\mu A/V$
r_a ($V_{g4} = -0.5$ V)	2	2.5	M Ω
r_a ($V_{g4} = -12$ V)	>10	10	M Ω

Short Wave working

V_a	135	V
V_{g2}	135	V
V_{g3+g5}	60	V
V_{osc} (r.m.s.)	6	V
I_a ($V_{g4} = -1.5$ V)	1.0	mA
I_{g2}	2.3	mA
I_{g3+g5}	1.0	mA
g_c ($V_{g4} = -1.5$ V)	67	$\mu A/V$
r_a ($V_{g4} = -1.5$ V)	1.7	M Ω

LIMITING VALUES

V_a max.	150	V
p_a max.	0.5	W
V_{g2} max.	150	V
p_{g2} max.	0.6	W
V_{g3+g5} max.	100	V
p_{g3+g5} max.	0.4	W
I_k max.	11	mA
R_{g4-k} max.	2.5	M Ω



BASE :
Octal

DIMENSIONS :
L=125mm
D=46 mm



4 VALVE DATA PREFERRED TYPES

B FREQUENCY CHANGERS

UCH 21 Triode heptode with variable-mu characteristics

HEATER

V_h 20 V I_h 0.1 A Suitable for series or parallel operation

CAPACITANCES

Identical with Type ECH 21, to which refer
For Circuit see Fig. 5, page 57

OPERATING CONDITIONS

Heptode Section as mixer

$V_a = V_b$	100	200	V
R_{g2+g4}	15	15	K Ω
R_k	150	150	Ω
R_{gt-k}	47	47	K Ω
I_{g3+gt}	95	190	μ A
V_{g1}	-1	-2	V
	-14	-28	V
V_{g2+g4}	53	100	V
I_a	1.5	3.5	mA
I_{g2+g4}	3.0	6.5	mA
g_c	580	750	μ A/V
	5.8	7.5	μ A/V
r_a	1.0	1.0	M Ω
	> 10	> 10	M Ω
R_{eq}	40	55	K Ω

Triode Section as R.F. oscillator

V_b	100	200	V
R_{at}	22	22	K Ω
R_{g3+gt}	47	47	K Ω
I_{g3+gt}	95	190	μ A
$V_{osc (r.m.s.)}$	4.5	9.0	V
I_a	1.9	4.1	mA
g_m (effective)	0.44	0.45	mA/V

CHARACTERISTICS

Triode Section

V_a	100	V
V_g	0	V
I_a	12	mA
g_m	3.2	mA/V
μ	19	

LIMITING VALUES

Heptode Section		Triode Section	
$V_{a(b)}$ max.	550 V	$V_{a(b)}$ max.	550 V
V_a max.	250 V	V_a max.	175 V
p_a max.	1.5 W	p_a max.	0.5W
$V_{g2+g4(b)}$ max.	550 V		
V_{g2+g4} max. ($I_a = 3$ mA)	100 V		
V_{g2+g4} max. ($I_a = 1$ mA)	250 V		
p_{g2+g4} max.	1.0 W		
I_k max.	15 mA		



BASE :
B8G

DIMENSIONS :
L=96 mm
D=32 mm

Triode hexode with variable- μ characteristics

UCH 42

HEATER

V_h 14.0 V I_h 0.1 A Suitable for series operation, A.C. or D.C.

CAPACITANCES

Similar to Type ECH 42, see page 49

OPERATING CONDITIONS

Hexode Section (see Fig. 7, page 58)

$V_a = V_b$		100		V
R_1		18		K Ω
R_2		27		K Ω
R_k		220		Ω
R_{g1+g3}		47		K Ω
I_{g1+g3}		100		μ A
V_{g2+g4}	41	59	59.5	V
V_{g1}	-1.0	-9.5	-11.5	V
I_a	1.2	0.07	0.04	mA
I_{g2+g4}	1.75	0.09	0.055	mA
g_o	520	10.4	5.2	μ A/V
r_a	0.85	7.0	9.0	M Ω
R_{eq}	36	—	—	K Ω
$V_a = V_b$		170		V
R_1		18		K Ω
R_2		27		K Ω
R_k		220		Ω
R_{g1+g3}		47		K Ω
I_{g1+g3}		170		μ A
V_{g2+g4}	71	100	101	V
V_{g1}	-1.7	-16	-19	V
I_a	2.5	0.15	0.08	mA
I_{g2+g4}	2.85	0.14	0.09	mA
g_o	610	12.2	6.1	μ A/V
r_a	1.1	9.0	>10	M Ω
R_{eq}	55	—	—	K Ω
$V_a = V_b$		200		V
R_1		18		K Ω
R_2		27		K Ω
R_k		220		Ω
R_{g1+g3}		47		K Ω
I_{g1+g3}		200		μ A
V_{g2+g4}	84	118	119	V
V_{g1}	-2.0	-18	-22	V
I_a	3.2	0.21	0.11	mA
I_{g2+g4}	3.35	0.17	0.1	mA
g_o	690	13.8	6.9	μ A/V
r_a	1.25	8.0	>10	M Ω
R_{eq}	64	—	—	K Ω

4 VALVE DATA PREFERRED TYPES

B FREQUENCY CHANGERS

UCH 42 (contd.)

Triode Section

V_b	100	170	200	V
R_{at}	22	22	22	K Ω
I_a	2.0	3.5	4.2	mA
R_{gt+g2}	47	47	47	K Ω
I_{gt+g2}	100	170	200	μ A
$V_{osc} (r.m.s.)$	4.7	8.0	9.4	V approx.

The effective mutual conductance of the triode section under the above conditions is approximately 0.5 mA/V

LIMITING VALUES

Heptode Section

$V_a (b)$ max.	550	V
V_a max.	250	V
p_a max.	0.8	W
$V_{g2+g4} (b)$ max.	550	V
V_{g2+g4} max.	125	V
P_{g2+g4} max.	0.3	W
I_k max.	10	mA
V_{b-k} max.	150	V

Triode Section

$V_a (b)$ max.	550	V
V_a max.	175	V
p_a max.	0.9	W
V_{gt} max. ($I_{gt}=0.3 \mu$ A)	-1.3	V
I_k max.	5.5	mA



BASE :
B8A

DIMENSIONS :
L=60 mm
D=22 mm

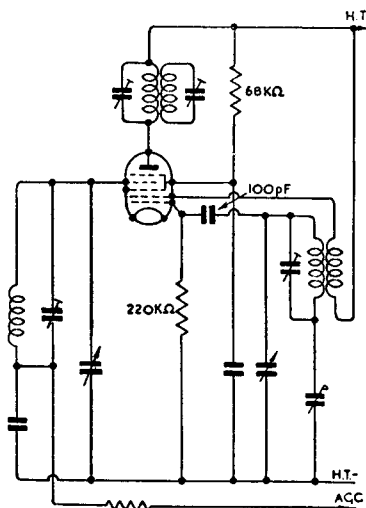

Fig. 2

Battery-operated Frequency Changer
Circuit using DK32 Heptode

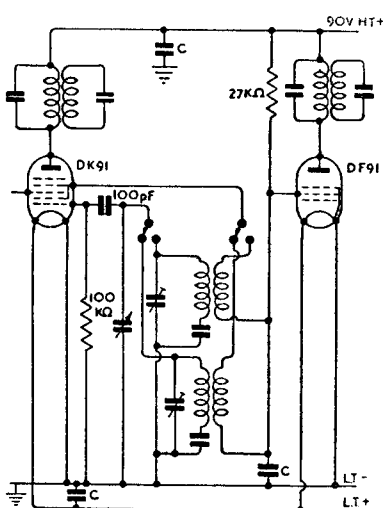

Fig. 3

Medium and Long Wave Battery-
operated Frequency Changer Circuit
using DK91 Heptode

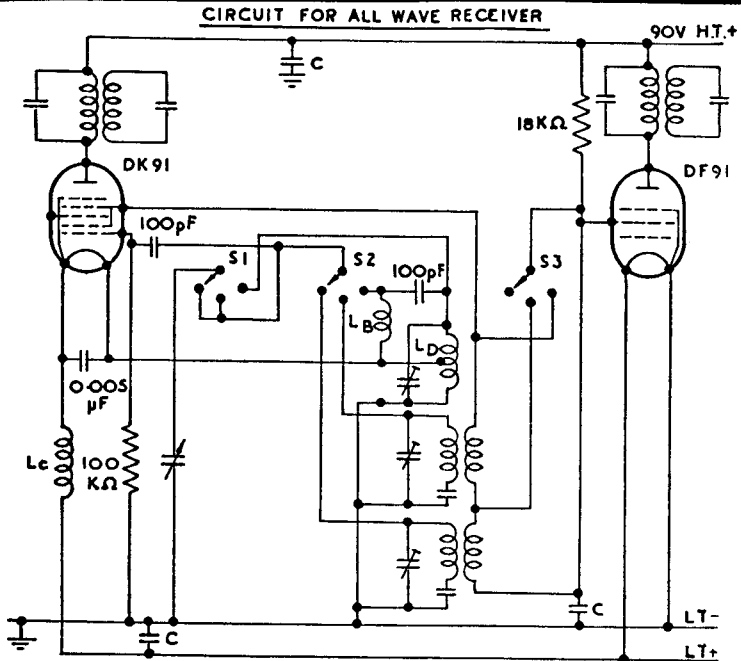

Fig. 4. All-wave Battery-operated Frequency Changer using DK91 Heptode

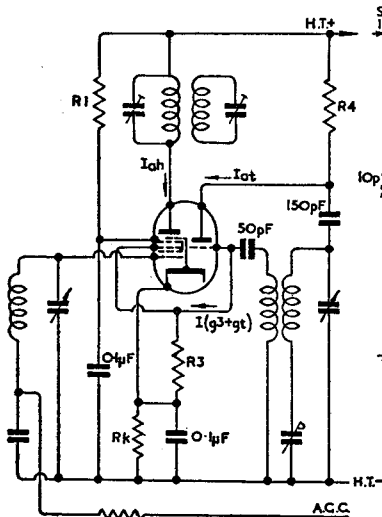

Fig. 5. A.C. Mains-operated Frequency Changer using ECH21 or UCH21 Triode-Hexode

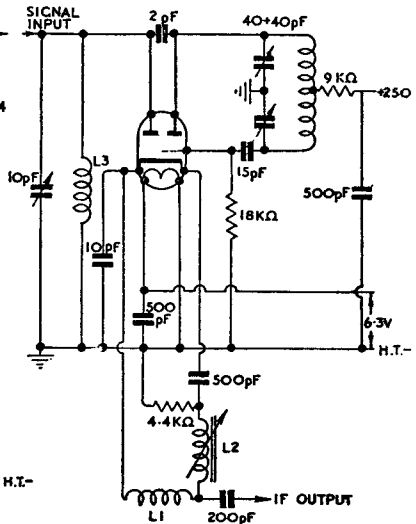

Fig. 6. U.H.F. Mains-operated Frequency Changer using EAC91 Diode-Triode

4 VALVE DATA
PREFERRED TYPES
B FREQUENCY CHANGERS

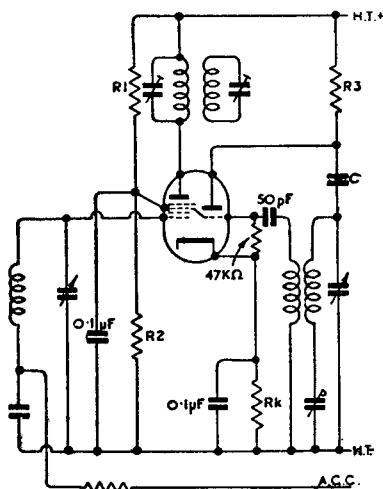
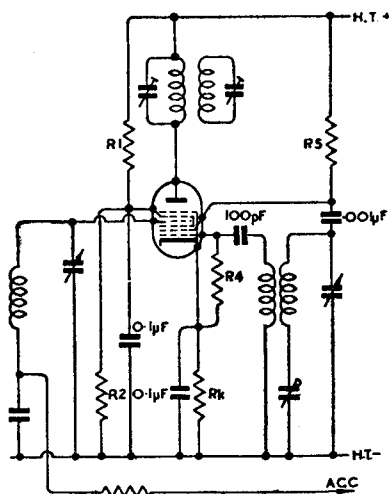

Fig. 7. A.C. Mains-operated Frequency Changer using CCH35, ECH35, ECH42 or UCH42 Triode-Hexode

Fig. 8. Mains - operated Frequency Changer using EK32 Octode



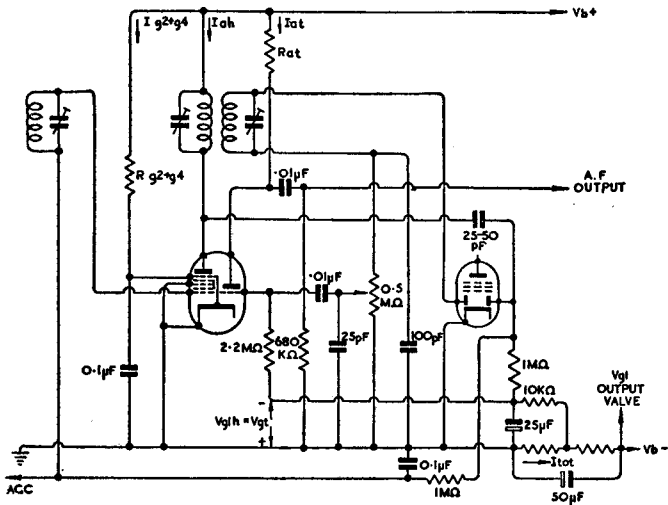

Fig. 9.—Circuit for triode-heptode as combined I.F. and A.F. amplifier.

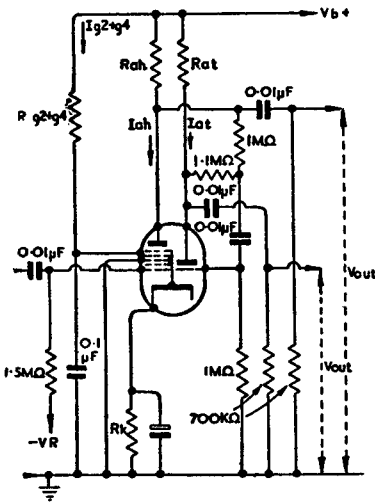

Fig. 10.

Circuit for phase inverter using ECH21 with negative feedback.

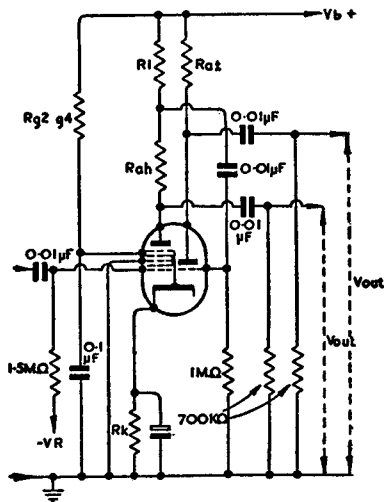

Fig. 11.

Circuit for phase inverter using ECH21 without feedback.

DIODES AND DOUBLE DIODES

A.C. MAINS

Type	Description	V_h	Base	Page
EA50	Miniature single diode	6.3 V	B3G	62
EB34	Double diode with separate cathodes. Internally screened and with screening between sections	6.3 V	Octal	62
EB41	Double diode with separate cathodes. Internally screened and with screening between sections	6.3 V	B8A	
EB91	Miniature double diode with separate cathodes. Internally screened between sections	6.3 V	B7G	62

D.C./A.C. MAINS

Type	Description	I_h	Base	Page
UB41	Double diode with separate cathodes. Internally screened and with screening between sections	0.1 A	B8A	63

The following valves also contain diode or double diode sections:—

BATTERY

Type	Description	V_f	Base	Page
DAC32	Single diode triode	1.4 V	Octal	66
DAF91	Single diode pentode	1.4 V	B7G	17
KBC32	Double diode triode	2.0 V	Octal	76

A.C. MAINS

Type	Description	V_h	Base	Page
EAC91	Diode triode	6.3 V	B7G	45
EA42	Diode pentode	6.3 V	B8A	22
EBC33	Double diode triode	6.3 V	Octal	66
EBC41	Double diode triode	6.3 V	B8A	67
EBF80	Double diode pentode	6.3 V	Noval (B9A)	23
EBL21	Double diode output pentode	6.3 V	Loctal (B8G)	90
EBL31	Double diode output pentode	6.3 V	Octal	91

D.C./A.C. MAINS

Type	Description	I_h	Base	Page
CBL31	Double diode output pentode	0.2 A	Octal	81
UAF42	Single diode pentode	0.1 A	B8A	37
UBC41	Double diode triode	0.1 A	B8A	77
UBF80	Double diode pentode	0.1 A	Noval (B9A)	38
UBL21	Double diode output pentode	0.1 A	Loctal (B8G)	107



4 VALVE DATA PREFERRED TYPES

C DIODES AND DOUBLE DIODES

EA 50 Miniature diode

HEATER

V_h 6.3 V I_h 0.15 A Suitable for A.C. mains operation

CAPACITANCE

C_{c-k} 2.1 $\mu\mu\text{F}$

LIMITING VALUES



V_a max.	50	V
I_a max.	5.0	mA
V_{h-k} max.	50	V

BASE :
B3G

DIMENSIONS :
L=49mm
D=12 mm

EB 34 Double diode (separate cathodes). Internally screened between sections

HEATER

V_h 6.3 V I_h 0.2 A Suitable for series or parallel operation

CAPACITANCES

C_{a-d-k} (each section)	4.5 $\mu\mu\text{F}$
$C_{a-d-k'}$	0.5 $\mu\mu\text{F}$

LIMITING VALUES



$V_{a-d'}$ max.	200	V
$V_{a-d''}$ max.	200	V
$I_{a-d'}$ max.	0.8	mA
$I_{a-d''}$ max.	0.8	mA
$V_{h-k'}$ max.	75	V
$V_{h-k''}$ max.	75	V
$V_{a-d'}$ max. ($I_{a-d''} = +0.3 \mu\text{A}$)	-1.3	V
$V_{a-d''}$ max. ($I_{a-d'} = +0.3 \mu\text{A}$)	-1.3	V
$V_{k'-k''}$ max.	50	V

BASE :
Octal

DIMENSIONS :
L=82 mm
D=36 mm

EB 41 Double diode (separate cathodes). Internally screened and screened between sections

HEATER

V_h 6.3 V I_h 0.3 A Suitable for series or parallel operation

CAPACITANCES

$C_{a-d-k'}$	<0.03 $\mu\mu\text{F}$
C_{k-all} (each section)	4.0 $\mu\mu\text{F}$
C_{a-d-k} (each section)	0.01 $\mu\mu\text{F}$

LIMITING VALUES

Each section

EB 41
(contd.)



V_{ad} max.	150	V
I_{ad} max.	9	mA
$I_{ad(pk)}$ max.	54	mA
V_{h-k} max.	300	V
V_{ad} ($I_{ad} = +0.3 \mu A$)	-1.3	V

BASE :
B8A

DIMENSIONS :
L=60 mm
D=22 mm

Miniature double diode (separate cathodes). Internally screened between sections

EB 91

HEATER

V_h 6.3 V I_h 0.3 A Suitable for series or parallel operation

CAPACITANCES

$C_{ad-k+h+s}$ (each section)	3.0	$\mu\mu F$
$C_{k-ad+h+s}$ (each section)	3.4	$\mu\mu F$
C_{ad-ad}	<0.025	$\mu\mu F$

LIMITING VALUES

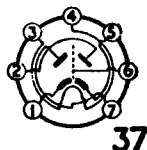

p_{iv} max.	420	V
I_{ad} max.	9	mA
$I_{ad(pk)}$ max.	54	mA
V_{ad} max. ($I_{ad} = 0.3 \mu A$)	-1.3	V
V_{h-k} (pk)	330	V

BASE :
B7G

DIMENSIONS :
L=55 mm
D=19 mm

Double diode with separate cathodes. Internally screened and screened between sections

UB41

HEATER

V_h 19 V I_h 0.1 A Suitable for series operation, A.C. or D.C.

CAPACITANCES

C_{ad-Cad}	<0.03	$\mu\mu F$
C_{ad-all} (each section)	4	$\mu\mu F$
C_{ad-k} (each section)	0.01	$\mu\mu F$

LIMITING VALUES

Each Section

V_{ad} max.	150	V
I_{ad} max.	9	mA
$I_{ad(pk)}$ max.	54	mA
V_{ad} max. ($I_{ad} = +0.3 \mu A$)	-1.3	V
V_{h-k} max.	300	V

BASE :
B8A

DIMENSIONS:
L=60 mm
D=22 mm



VOLTAGE AMPLIFYING TRIODES

BATTERY

Type	Description	V_f	Base	Page
DAC32	Single diode triode	1.4	Octal	66
KBC32	Double diode triode	2.0	Octal	76

A.C. MAINS

Type	Description	V_h	Base	Page
EBC33	Double diode triode	6.3	Octal	66
EBC41	Double diode triode	6.3	B8A	67
EC31	Low impedance triode	6.3	Octal	69
ECC31	Double triode with common cathode	6.3	Octal	70
ECC33	Double triode with separate cathodes	6.3	Octal	71
ECC34	Low impedance double triode with separate cathodes	6.3	Octal	72
ECC35	Double triode with separate cathodes	6.3	Octal	73
ECC40	Double triode with separate cathodes	6.3	B8A	74
ECC91	Miniature double triode	6.3	B7G	75

D.C./A.C. MAINS

Type	Description	I_h	Base	Page
UBC41	Double diode triode	0.1 A	B8A	77

The following voltage amplifying pentodes may also be used as triodes:—

A.C. MAINS

Type	Description	V_h	Base	Page
EAF42	Single diode pentode	6.3	B8A	22
EF37	Low microphony A.F. pentode ...	6.3	Octal	25
EF37A	Low microphony, low hum A.F. pentode	6.3	Octal	25

The following multiple valve described in Section F "Output Pentodes" has a triode section:—

Type	Description	V_h	Base	Page
ECL80	Triode-output pentode	6.3	B9A (Noval)	92



4 VALVE DATA PREFERRED TYPES

D VOLTAGE AMPLIFYING TRIODES

DAC 32 Single diode triode

FILAMENT

V_f 1.4 V I_f 0.05 A Suitable for D.C. operation only

CAPACITANCES

Triode section	C_{g-k}	1.3	$\mu\mu\text{F}$
	C_{a-k}	6.0	$\mu\mu\text{F}$
	C_{a-g}	1.0	$\mu\mu\text{F}$
Diode section	C_{ad-f}	3.2	$\mu\mu\text{F}$
	C_{ad-g}	0.002	$\mu\mu\text{F}$
	C_{a1-at}	0.2	μ

The diode anode is located at the negative end of the filament

OPERATING CONDITIONS

Triode Section as Class "A" Amplifier

V_a	90	V
V_g	0	V
I_a	0.15	mA
μ	65	
r_a	240	K Ω
g_m	275	$\mu\text{A/V}$

LIMITING VALUE

V_a max.	110	V
------------	-----	---



BASE :
Octal

DIMENSIONS :

$L=102$ mm
 $D=30$ mm

EBC33 Double diode triode

HEATER

V_h 6.3 V I_h 0.2 A Suitable for series or parallel operation

CAPACITANCES

C_{ad-k}	2.6	$\mu\mu$
C_{ad-k}	3.2	$\mu\mu\text{F}$
C_{ad-ad}	<0.7	$\mu\mu\text{F}$

OPERATING CONDITIONS

As Transformer Coupled A.F. Amplifier

V_a	100	200	250	V
I_a	2	4	5	mA
V_g	-2.1	-4.3	-5.5	V
μ	30	30	30	
g_m	1.6	2.0	2.0	mA/V
r_a	19	15	15	K Ω



VOLTAGE AMPLIFYING TRIODES **D**

EBC 33
(contd.)

OPERATING CONDITIONS

As resistance coupled A.F. amplifier

V_b (V)	R_a (K Ω)	I_a (mA)	R_k (K Ω)	$\frac{V_{out}}{V_{in}}$	V_{out}^* (V)	D_{tot} (%)	R_{g1}^{**} (K Ω)
300	47	2.8	1.2	19.5	45	5.8	150
250	47	2.3	1.2	19.0	34	5.5	150
200	47	1.8	1.2	18.5	26	5.2	150
100	47	0.5	4.7	13.0	8	10.0	150
300	100	1.5	2.2	22.0	49	5.2	330
250	100	1.27	2.2	22.0	41	5.2	330
200	100	1.0	2.2	21.5	31	5.0	330
100	100	0.32	6.8	16.5	14	10.0	330
300	220	0.83	3.9	23.5	52	4.8	680
250	220	0.69	3.9	23.5	41	4.6	680
200	220	0.53	3.9	23.0	31	4.5	680
100	220	0.2	10	19.0	20	10.0	680

* V_{out} = Output voltage at start of I_g or $D_{tot} = 10\%$

** R_{g1} = Grid resistance of following valve

LIMITING VALUES

$V_{a,b}$ max.	550	V
V_a max.	300	V
p_a max.	1.5	W
I_k max.	10	mA
R_{g-k} max. (Self bias)	3	M Ω
R_{g-k} max. (Fixed bias)	1	M Ω
V_{h-k} max.	100	V

Each diode

V_{ad} max.	200	V
I_{ad} max.	0.8	mA
V_{h-k} max.	100	V

BASE :
Octal

DIMENSIONS :

L=100 mm
D=32 mm

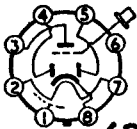

62

Double diode triode

EBC 41

HEATER

V_h 6.3 V I_h 0.225 A Suitable for A.C. operation only

CAPACITANCES

C_{gd-ndr}	<0.15	$\mu\mu F$
$C_{gd+ndr-at}$	<0.02	$\mu\mu F$
C_{gd-gt}	<0.007	$\mu\mu F$
C_{gd-gt}	<0.03	$\mu\mu F$
C_{gd-h}	<0.05	$\mu\mu F$



4 VALVE DATA PREFERRED TYPES

D VOLTAGE AMPLIFYING TRIODES

EBC 4J CHARACTERISTICS

(contd.)	V_a	250	V
	I_a	1.0	mA
	V_g	-3.0	V
	μ	70	
	g_m	1.3	mA/V
	r_a	54	K Ω

OPERATING CONDITIONS

As resistance coupled A.F. amplifier (with cathode bias)

V_b (V)	R_a (K Ω)	I_a (mA)	R_k (K Ω)	V_{out} V_{in}	V_{out} (V_{rms}) (D_{tot} 5%)	V_{out} (V_{rms}) (D_{tot} 10%)	R_{g1}^* (K Ω)
400	100	1.35	2.2	43.5	35.5	62.5	330
350	100	1.18	2.2	43	30.5	54	330
300	100	1.0	2.2	42.5	25.5	46	330
250	100	0.85	2.2	42	21	38	330
200	100	0.7	2.2	41	16	28.5	330
150	100	0.5	2.2	40	12	19.5	330
100	100	0.28	3.3	33.5	6	10.5	330
400	220	0.76	3.9	48	40	74.5	680
350	220	0.67	3.9	47.5	34.5	64	680
300	220	0.56	3.9	47	27	54	680
250	220	0.48	3.9	46.5	24.5	44.5	680
200	220	0.4	3.9	46	19	34	680
150	220	0.32	3.9	44	16.5	24	680
100	220	0.18	5.6	38	8	13.5	680

* R_{g1} = Grid resistance of following valve

OPERATING CONDITIONS

As resistance coupled A.F. amplifier** (with grid-current bias)

V_b (V)	R_a (K Ω)	I_a (mA)	V_{out} V_{in}	V_{out} (V_{rms}) (D_{tot} 2.5%)	V_{out} (V_{rms}) (D_{tot} 5%)	R_{g1}^* (K Ω)
400	100	2.4	56.5	33	51	330
350	100	2.0	55	27	43	330
300	100	1.95	53.5	22	35	330
250	100	1.3	51	17	27	330
200	100	0.95	48.5	12	19	330
150	100	0.6	44	7	11	330
100	100	0.3	35.5	3	5	330
400	220	1.3	62.5	34	55.5	680
350	220	1.1	61.5	29	47	680
300	220	0.9	59.5	23	38	680
250	220	0.7	57	17	29.5	680
200	220	0.5	54	12.5	21	680
150	220	0.33	49	8	14	680
100	220	0.18	40	4	7	680

**Measured with grid resistance of 20M Ω and signal source impedance $Z_s=0$. The distortion figures quoted hold good for valves of Z_s not exceeding 0.2 M Ω . At this value of Z_s the gain will be reduced by 10%.

* R_{g1} = Grid resistance of following valve.



VOLTAGE AMPLIFYING TRIODES D

LIMITING VALUES

$V_{a(b)}$ max.	550	V
V_a max.	300	V
I_k max.	5	mA
p_a max.	0.5	W
R_{g-k} max. (cathode bias)	3	M Ω
V_{h-k} max.	100	V
$V_{ad(pk)}$ max.	200	V
I_{ad} max.	0.8	mA

EBC 41
(contd.)



BASE:
B8A

DIMENSIONS:
L=60 mm
D=22 mm

(ad' to pin 6, ad'' to pin 5)

Low impedance triode, for use as voltage amplifier or low power output valve

EC 31

HEATER

V_h 6.3 V I_h 0.65 A Suitable for A.C. mains operation

OPERATING CONDITIONS

As R.C. amplifier

$V_{a(b)}$	250	350	450	550	V
R_a	82	100	120	150	K Ω
V_{in} (r.m.s.)	5.8	9.0	11.5	13.0	V
I_a	1.6	2.0	2.3	2.5	mA
R_k	8.2	8.2	8.2	8.2	K Ω
V_{out}/V_{in}	7.2	6.5	7.0	7.4	

OPERATING CONDITIONS

as output valve (Class "A")

V_a	250	V
V_g	-16	V
I_a	20	mA
R_k	800	Ω
g_m	3.2	mA/V
μ	10.5	
r_a	3.3	K Ω
R_a	10	K Ω
$V_{in(rms)}$	9.1	V
P_{out} ($D_{tot}=5\%$)	0.5	W



4 VALVE DATA PREFERRED TYPES

D VOLTAGE AMPLIFYING TRIODES

EC 31 LIMITING VALUES

(contd.)

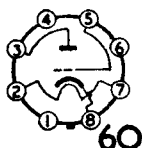

V_a max.	250	V
p_a max.	5	W
I_k max.	30	mA
R_{g-k} max.	1.0	M Ω
V_{k-k} max.	50	V

BASE :
Octal

DIMENSIONS:
L=124 mm
D=48 mm

ECC 31 Double diode with common cathode

HEATER

V_h 6.3 V I_h 0.95 A Suitable for A.C. mains operation

CAPACITANCES

$C_{a'-g'}$	3.4	$\mu\mu\text{F}$	$C_{o''-g''}$	3.75	$\mu\mu\text{F}$
C'_{g-k}	4.0	$\mu\mu\text{F}$	$C_{g''-k}$	4.0	$\mu\mu\text{F}$
$C_{a'-x}$	1.9	$\mu\mu\text{F}$	$C_{a''-x}$	1.0	$\mu\mu\text{F}$

CHARACTERISTICS

Each section

V_a	250	V
V_g	-4.6	V
I_a	6.0	mA
g_m	2.3	mA/V
μ	32	
r_a	14	K Ω

OPERATING CONDITIONS

As R.C. coupled amplifier

V_b (V)	R_s (K Ω)	I_a (mA)	R_k (K Ω)	$\frac{V_{out}}{V_{in}}$	V_{out}^* (V)	D_{tot} (%)	R_{gz}^* (K Ω)
400	47	3.9	1.2	21	67	3.7	150
350	47	3.4	1.2	20.5	57	3.6	150
300	47	2.9	1.2	20	48	3.5	150
250	47	2.4	1.2	19.5	37	3.4	150
200	47	1.9	1.2	19.5	26	3.2	150
400	100	2.1	2.7	25	81	3.0	330
350	100	1.8	2.2	25	69	2.9	330
300	100	1.6	2.2	24.5	54	2.8	330
250	100	1.3	2.2	24.5	44	2.6	330
200	100	1.05	2.2	24	32	2.4	330



VOLTAGE AMPLIFYING TRIODES **D**

OPERATING CONDITIONS (contd.)

ECC 31
(contd.)

V_b (V)	R_a (K Ω)	I_a (mA)	R_k (K Ω)	$\frac{V_{out}}{V_{in}}$	V_{out}^* (V)	D_{tot} (%)	R_{g1}^{**} (K Ω)
400	220	1.1	3.9	27.5	81	2.3	680
350	220	0.95	3.9	27.5	68	2.2	680
300	220	0.85	3.9	27	56	2.2	680
250	220	0.7	3.9	27	45	2.1	680
200	220	0.55	3.9	26.5	34	2.0	680

* V_{out} = Output voltage at start of I_g or at $D_{tot} = 10\%$

** R_{g1} = Grid resistance of following valve

LIMITING VALUES



V_a max.	300	V
p_a max. (each section)	5	W
I_k max.	2×25	mA
R_{g-k} max.	1.5	M Ω
V_{h-k} max.	50	V

BASE :
Octal

DIMENSIONS :
L = 106 mm
D = 46 mm

Double triode with separate cathodes

ECC 33

HEATER

V_h 6.3 V I_h 0.4A The heaters of the two cathodes are connected in series

CAPACITANCES

$C_{a'-a''}$	0.75	$\mu\mu\text{F}$
C_{a-g} (each section)	2.5	$\mu\mu\text{F}$
C_{g-k} (each section)	3.5	$\mu\mu\text{F}$
$C_{a'-k'}$	1.2	$\mu\mu\text{F}$
$C_{a''-k''}$	1.5	$\mu\mu\text{F}$

g', a', k' -pins 1, 2 & 3
 g'', a'', k'' -pins 4, 5 & 6

CHARACTERISTICS

Each section

V_a	250	V
V_g	-4.0	V
I_a	9.0	mA
g_m	3.6	mA/V
μ	35	
r_a	9.7	K Ω



4 VALVE DATA PREFERRED TYPES

D VOLTAGE AMPLIFYING TRIODES

ECC 33 (contd.)

OPERATING CONDITIONS

As R.C. coupled A.F. amplifier

V_b (V)	R_a (K Ω)	I_a (mA)	R_k (K Ω)	$\frac{V_{out}}{V_{in}}$	V_{out}^* (V)	D_{tot} (%)	R_{g1}^{**} (K Ω)
400	47	4.0	1.2	25.5	74	6.1	150
350	47	3.5	1.2	25	62.5	5.9	150
300	47	3.0	1.2	25	50	5.6	150
250	47	2.5	1.2	25	41	5.6	150
200	47	2.0	1.2	24.5	30.5	5.3	150
400	100	2.05	2.2	28	78.5	5.7	330
350	100	1.8	2.2	27.5	66.5	5.6	330
300	100	1.55	2.2	27	54.5	5.6	330
250	100	1.3	2.2	27	43	5.4	330
200	100	1.05	2.2	26.5	32	5.2	330
400	220	1.1	3.9	28	74.5	5.1	680
350	220	0.98	3.9	28	63	5.0	680
300	220	0.83	3.9	28	51	5.0	680
250	220	0.7	3.9	27.5	41	4.8	680
200	220	0.53	3.9	27	30.5	4.8	680

*Output voltage at start of I_g . At output voltages lower than those shown, the distortion is approximately proportional to the voltage

**Grid resistance of the following valve

LIMITING VALUES

Each section

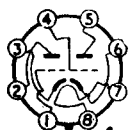

64

$V_{a(b)}$ max.	550	V
V_a max.	300	V
p_a max.	2.5	W
I_k max.	20	mA
R_{g-k} max.	1.5	M Ω
V_{h-k} max.	100	V

BASE :
Octal

DIMENSIONS :
L=82 mm
D=33 mm

ECC 34

Low impedance, double triode, with separate cathodes

HEATER

V_h 6.3 V I_h 0.95 A Suitable for A.C. mains operation

CAPACITANCES

Each section

$C_{a-a'}$	0.48	$\mu\mu\text{F}$
C_{a-g}	4.0	$\mu\mu\text{F}$
C_{g-k}	3.5	$\mu\mu\text{F}$
C_{a-k}	1.8	$\mu\mu\text{F}$

VOLTAGE AMPLIFYING TRIODES **D**

OPERATING CONDITIONS

V_a	250	V
I_a	10	mA
V_g	-16	V
g_m	2.2	mA/V
r_a	5.2	K Ω
μ	11.5	

ECC 34
(contd.)

LIMITING VALUES

$V_{a(b)}$ max.	550	V
V_a max.	300	V
p_a max.	3.25	W
I_k max.	2 x 25	mA
V_{h-k} max.	50	V
R_{g-k} max.	2.0	M Ω



BASE :
Octal

DIMENSIONS :
L = 106 mm
D = 46 mm

Double triode with separate cathodes

ECC 35

HEATER

V_h 6.3 V I_h 0.4 A Suitable for A.C. mains operation

CAPACITANCES

$C_{g'-g}$	0.75	$\mu\mu\text{F}$
$C_{a'-g}$	2.5	$\mu\mu\text{F}$
$C_{g'-k'}$	3.0	$\mu\mu\text{F}$
$C_{a'-k'}$	1.0	$\mu\mu\text{F}$
$C_{g''-g}$	3.0	$\mu\mu\text{F}$
$C_{g''-k''}$	3.0	$\mu\mu\text{F}$
$C_{a''-k''}$	1.3	$\mu\mu\text{F}$

g', a', k' -pins 1, 2, 3
 g'', a'', k'' -pins 4, 5, 6

CHARACTERISTICS

V_a	250	V
V_g	-2.5	V
I_a	2.3	mA
g_m	2.0	mA/V
μ	68	
r_a	34	K Ω



4 VALVE DATA PREFERRED TYPES D VOLTAGE AMPLIFYING TRIODES

ECC 35 OPERATING CONDITIONS

(contd.)

As R.C. coupled A.F. amplifier

V_b (V)	R_a (K Ω)	I_a (mA)	R_k (K Ω)	$\frac{V_{out}}{V_{in}}$	V_{out}^* (V)	V_{out}^\dagger (V)	D_{tot} (%)	R_{g1}^{**} (K Ω)
400	100	1.3	2.7	40.5	37.5	66.2	10	330
350	100	1.1	2.7	40.5	32.2	57	10	330
300	100	1.0	2.7	40	28	48.7	10	330
250	100	0.8	2.7	40	23.2	41.1	10	330
200	100	0.65	2.7	39.5	18.7	28.5	8	330
400	220	0.73	4.7	46	44	80	10	680
350	220	0.63	4.7	45.5	38	69.3	10	680
300	220	0.53	4.7	45.5	32.5	59	10	680
250	220	0.45	4.7	45	27	43	8.5	680
200	220	0.38	4.7	45	21.5	33.6	8.2	680

*At $D_{tot}=5\%$

†At $D_{tot}=10\%$ or start of I_a

**Grid resistance of following valve

LIMITING VALUES

Each section

$V_{a(b)}$ max.	550	V
V_a max.	300	V
P_a max.	1.5	W
I_k max.	8.0	mA
R_{g-k} max.	1.5	M Ω
V_{h-k} max.	90	V

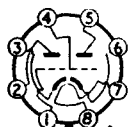

BASE :
Octal

DIMENSIONS :
L=83 mm
D=33 mm

ECC 40 Low microphony double triode with separate cathodes

HEATER

V_h 6.3 V I_h 0.6 A Suitable for A.C. mains operation

CAPACITANCES

$C_{g'-h}$	< 0.1	$\mu\mu\text{F}$	$C_{g''-h}$	< 0.1	$\mu\mu\text{F}$
$C_{a'-g'}$	2.7	$\mu\mu\text{F}$	$C_{a''-g''}$	2.6	$\mu\mu\text{F}$
$C_{g'-k}$	2.6	$\mu\mu\text{F}$	$C_{g''-k''}$	3.0	$\mu\mu\text{F}$
$C_{a'-g''}$	< 0.1	$\mu\mu\text{F}$	$C_{a''-g'}$	< 0.1	$\mu\mu\text{F}$

CHARACTERISTICS

Each section

V_a	250	V
V_{g1}	-5.2	V
I_a	6	mA
g_m	2.7	mA/V
r_a	11	K Ω
μ	30	

VOLTAGE AMPLIFYING TRIODES **D**

OPERATING CONDITIONS

As R.C. coupled A.F. amplifier

ECC 40
(contd.)

V_b (V)	i_a (mA)	R_k (Ω)	V_{ont} V_{in}	V_{out}^* (V_{rms})	D_{tot} (%)	$R_{g\uparrow}$ (K Ω)
400	7	1,200	21	72.5	4.4	150
350	7	1,200	20.5	60	4.1	150
300	7	1,200	20	50	4.0	150
250	4.7	1,200	20	40	3.8	150
200	4.7	1,200	20	29.5	3.4	150
400	100	2,200	24.5	76	3.9	330
350	100	2,200	24	65	3.9	330
300	100	2,200	24	54	3.8	330
250	100	2,200	24	44	3.7	330
200	100	2,200	24	33	3.6	330
400	220	3,900	25	72	3.8	680
350	220	3,900	25	63	3.7	680
300	220	3,900	25	53	3.7	680
250	220	3,900	25	44	3.6	680
200	220	3,900	24.5	32	3.5	680

*Output voltage at start of i_g , at lower output voltages the distortion is reduced in proportion.

†Grid resistance of the following valve.

LIMITING VALUES

Each section

$V_{a(b)}$ max.	550	V
V_a max.	300	V
p_a max.	1.5	W
i_k max.	10	mA
R_{g-k} max.	1	M Ω
V_{h-k} max.	175	V

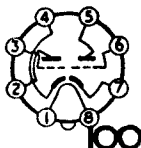

BASE :
B8A

DIMENSIONS :
L=67 mm
D=22 mm

Miniature double triode

ECC 91

HEATER

V_h 6.3 V i_h 0.45 A Suitable for A.C. mains operation

For use in transmitters see Section H, page 130

CAPACITANCES

Each section

C_{a-g}	1.6	$\mu\mu\text{F}$
C_{g-k}	2.2	$\mu\mu\text{F}$
C_{a-k}	0.4	$\mu\mu\text{F}$



4 VALVE DATA PREFERRED TYPES

D VOLTAGE AMPLIFYING TRIODES

ECC 91 CHARACTERISTICS

(contd.)

Each section

V_a	100	V
V_g	-0.85	V
I_a	8.5	mA
R_{k1}	50	Ω^*
g_m	5.3	mA/V
μ	38	
r_a	7.1	K Ω

*Value for both sections working under specified conditions

LIMITING VALUES

V_a max.	300	V
p_a max.	2×1.5	W
V_g max.	-40	V
I_g max.	2×8	mA
V_{h-k} max.	100	V
R_{g-k} max. (self bias)	0.5	M Ω

BASE :
87G

DIMENSIONS :

L=54 mm
D=19 mm

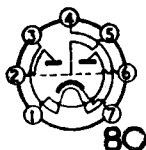

KBC 32 Double diode triode

FILAMENT

V_f 2.0 V I_f 0.05 A Suitable for D.C. operation only

CAPACITANCES

C_{a-f}	7.0	$\mu\mu\text{F}$
C_{g-f}	1.9	$\mu\mu\text{F}$
C_{a-g}	3.1	$\mu\mu\text{F}$
C_{ad-all} (each section)	2.5	$\mu\mu\text{F}$
$C_{ad'-ad''}$	< 0.5	$\mu\mu\text{F}$
C_{ad-g} (each section)	< 0.05	$\mu\mu\text{F}$
$C_{ad'-at}$	< 0.6	$\mu\mu\text{F}$
$C_{ad''-at}$	< 0.3	$\mu\mu\text{F}$

CHARACTERISTICS

V_a	100	V
V_g	0	V
I_a	2.4	mA
g_m	1.2	mA/V
μ	25	
r_a	21	K Ω

TYPICAL OPERATING CONDITIONS

As R.C. coupled A.F. amplifier

$V_{a(b)}$	120	120	V
R_a	47	100	K Ω
V_g	-1.5	-0.9	V
I_a	0.6	0.5	mA

LIMITING VALUE

V_a max.	150	V
BASE :	Octal	
DIMENSIONS :	L=110 mm	
	D=33 mm	

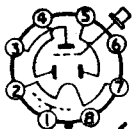

61



Double diode triode

UBC 41

HEATER

V_h 14.0 V I_h 0.1 A Suitable for series operation, D.C. or A.C.

CAPACITANCES

C_{ad-cad}	<0.15 $\mu\mu\text{F}$
$C_{ad-cad-ht}$	<0.02 $\mu\mu\text{F}$
C_{ad-g}	<0.007 $\mu\mu\text{F}$
C_{ad-s}	<0.03 $\mu\mu\text{F}$
C_{ad-h}	<0.05 $\mu\mu\text{F}$

CHARACTERISTICS

V_a	100	170	V
V_g	-1	-1.6	V
I_a	0.8	1.5	mA
g_m	1.4	1.65	mA/V
μ	70	70	
r_a	50	42	K Ω

OPERATING CONDITIONS

For resistance capacity coupled amplifier data see Type EBC 41, page 68

LIMITING VALUES

$V_{a(b)}$ max.	550	V
V_a max.	300	V
p_a max.	0.5	W
R_{g-k} max. (cathode bias)	3	M Ω
V_{h-k} max.	150	V

Each Diode Section

$V_{ad(pk)}$ max.	200	V
I_{ad} max.	0.8	mA

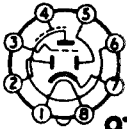

97

BASE :
B8A

DIMENSIONS :
L=60 mm
D=22 mm

BATTERY **OUTPUT PENTODES**

Type	Description	V_r (V)	Base	Page
DL33	Output pentode	1.4 2.8	Octal	83
DL35	Output pentode		1.4	Octal
DL66	Sub-miniature output pentode ...	1.25	B5A	84
DL71	Sub-miniature output pentode ...	1.25	B8D	85
DL72	Sub-miniature output pentode ...	1.25	B8D	86
DL92	Miniature output pentode	1.4 2.8	B7G	87
DL93	Miniature output pentode		1.4 2.8	B7G
DL94	Miniature output pentode	1.4 2.8	B7G	89
KL35	Output pentode		2.0	Octal
KLL32	Double output pentode	2.0	Octal	104

A.C. MAINS

Type	Description	V_h (V)	Base	Page
EBL21	Double diode output pentode (p_a max.=11 W)	6.3	B8G (Loctal)	90
EBL31	Double diode output pentode (p_a max.=9 W)	6.3	Octal	91
ECL80	Triode pentode. Pentode section (p_a max.=3.5 W)	6.3	B9A (Noval)	92
EL31	Output pentode (p_a max.=25 W)	6.3	Octal	94
EL32	Output pentode (p_a max.=8 W)...	6.3	Octal	95
EL33	Output pentode (p_a max.=9 W)...	6.3	Octal	96
EL37	Output pentode (p_a max.=25 W)...	6.3	Octal	97
EL38	Output pentode for use as line time base output valve	6.3	Octal	99
EL38M	Output pentode for use as line time base output valve (metallised) ...	6.3	Octal	99
EL41	Output pentode (p_a max.=9 W) ...	6.3	B8A	101
EL42	Output pentode particularly suitable for use in car radio receivers (p_a max.=6 W)	6.3	B8A	101
EL91	Miniature output pentode (p_a max.=4W)	6.3	B7G	103



4 VALVE DATA PREFERRED TYPES

E OUTPUT PENTODES

D.C./A.C. MAINS

Type	Description	I_h (A)	Base	Page
CBL31	Double diode output pentode (p_a max.=9 W)	0.2	Octal	81
CL33	High sensitivity output pentode (p_a max.=9 W)	0.2	Octal	82
PL33	Output pentode suitable for use as frame time base output or audio output valve (p_a max.=9 W) ...	0.3	Octal	105
PL38	Output pentode for use as line time base output valve	0.3	Octal	106
PL38M	Output pentode for use as line time base output valve (metallised)	0.3	Octal	106
UBL21	Double diode output pentode (p_a max.=11 W)	0.1	B8G (Loctal)	107
UL41	Output pentode (p_a max.=9 W) ...	0.1	B8A	108



Double diode output pentode

CBL 31

HEATER

V_h 44 V I_h 0.2 A Suitable for series operation, A.C. or D.C.

CAPACITANCES

$C_{a,d-k}$ (each section)	3.5	$\mu\mu F$
$C_{w,d-a^*d}$	<0.5	$\mu\mu F$

OPERATING CONDITIONS

as Class "A" amplifier

V_a	200	V
V_{g2}	200	V
V_{g1}	-8.5	V
I_a	45	mA
I_{g2}	6	mA
g_m	8	mA/V
r_a	35	K Ω
R_a	4.5	K Ω
$V_{in(r.m.s.)}$	5	V
$V_{in(r.m.s.)}$ ($P_{out}=50$ mW)	0.5	V
P_{out}	4	W
D_{tot}	10	%
R_k	167	Ω

LIMITING VALUES

Pentode Section

$V_{a(b)}$ max.	550	V
V_a max.	250	V
p_a max.	9	W
I_k max.	70	mA
$V_{g2(b)}$ max.	550	V
V_{g2} max.	250	V
p_{g2} max.	2	W
R_{g1-k} (self bias)	1	M Ω
V_{h-k}	125	V

Diode Sections

$V_{a,d}$ max.	200	V
V_{a^*d} max.	200	V
$I_{a,d}$ max.	0.8	mA
I_{a^*d} max.	0.8	mA
$V_{a,d}$ max. ($I_{a^*d}=+0.3$ μA)	-1.3	V
V_{a^*d} max. ($I_{a,d}=+0.3$ μA)	-1.3	V

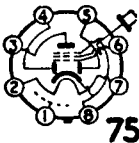

BASE :
Octal

DIMENSIONS :

L=136 mm
D=46 mm



4 VALVE DATA PREFERRED TYPES

E OUTPUT PENTODES

CL 33 High sensitivity output pentode

HEATER

V_h 33.0 V I_h 0.2 A Suitable for series operation, D.C. or A.C.

OPERATING CONDITIONS

Single valve Class "A"

	As pentode	As triode with screen connected to anode	
V_a	200	200	V
V_{g2}	200	—	V
V_{g1}	-8.5	-10	V
I_a	45	37.5	mA
I_{g2}	6	—	mA
g_m	8	7.5	mA/V
r_a	35	1.8	K Ω
μ_{g1-g2}	13.5	13.5	
R_a	4.5	7.0	K Ω
$V_{in(r,m,s)}$	5.0	6.0	V
$V_{in(r,m,s)} (P_{out}=50 \text{ mW})$	0.5	—	V
P_{out}	4.0	0.7	W
D_{tot}	10	10	%
R_k	180	270	Ω

OPERATING CONDITIONS

As Class "A" push-pull pair

V_a	200	V
V_{g2}	200	V
R_k	150	Ω
$I_{a(o)}$	2 x 33	mA
$I_{g2(o)}$	2 x 5	mA
R_{a-s}	4.5	K Ω
$V_{in(r,m,s)}$	2 x 5	V
P_{out}	8	W
D_{tot}	1.5	%

LIMITING VALUES

$V_{a(b)}$ max.	400	V
V_a max.	250	V
p_a max.	9	W
$V_{g2(b)}$ max.	400	V
V_{g2} max.	250	V
p_{g2} max.	2	W
I_k max.	70	mA
R_{g1-k} max. (self bias)	1	M Ω
V_{h-k} max.	175	V

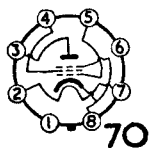

BASE :
Octal

DIMENSIONS :
L=126 mm
D=45 mm

DL 33

Output pentode

FILAMENT Suitable for D.C. operation only

- (a) Series : V_f applied across the two filament sections in series, between pins 2 and 7. V_{g1} referred to pin 7
- (b) Parallel : V_f applied across the two filament sections in parallel, between pin 8 and pins 2 and 7 connected together. V_{g1} referred to pin 8

	Series	Parallel	
V_f	2.8	1.4	V
I_f	0.05	0.1	A

OPERATING CONDITIONS

As Class "A" amplifier

Filament	Series			Parallel		
V_a	90	110	85	90	110	V
V_{g2}	90	110	85	90	110	V
V_{g1}	-4.5	-6.6	-5.0	-4.5	-6.6	V
$V_{in(r.m.s.)}$	3.2	3.6	3.5	3.2	3.8	V
I_a	8.0	8.5	7.0	9.5	10.0	mA
I_{g2}	1.0	1.1	0.8	1.3	1.4	mA
g_m	2.0	2.0	1.95	2.2	2.2	mA/V
r_a	80	110	70	90	100	K Ω
R_a	8	8	9	8	8	K Ω
P_{out}	230	330	250	270	400	mW
D_{tot}	8.5	8.5	5.5	6.0	6.0	%

LIMITING VALUES

Filament	Series	Parallel	
V_a max.	110	110	V
V_{g2} max.	110	110	V
$I_{k(o)}$ max.	6*	12	mA
R_{g1-r} max.	1.0	1.0	M Ω

*For each 1.4 V section

BASE : **DIMENSIONS:**
 Octal L=100 mm
 D=30 mm



69

Output pentode

DL 35

FILAMENT Suitable for D.C. operation only

V_f 1.4 V I_f 0.1 A

OPERATING CONDITIONS

As Class "A" amplifier

V_a	83	90	V
V_{g2}	83	90	V
V_{g1}	-7.0	-7.5	V
$V_{in(r.m.s.)}$	5.0	5.3	V
I_a (max. sig.)	7.3	7.8	mA
$I_{a(o)}$	7.0	7.5	mA
I_{g2} (max. sig.)	3.5	3.5	mA
$I_{g2(o)}$	1.6	1.6	mA
r_a (approx.)	110	115	K Ω
g_m	1.5	1.55	mA/V
R_a	9	8	K Ω
P_{out} ($D_{tot} = 10\%$)	200	240	mW



4 VALVE DATA PREFERRED TYPES

E OUTPUT PENTODES

DL 35 LIMITING VALUES (contd.)

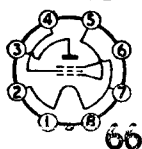

V_a max.	110	V
V_{g2} max.	110	V
I_k max.	12	mA

BASE :
Octal

DIMENSIONS :
L=92 mm
D=30 mm

DL 66 Sub-miniature output pentode for use in hearing aids

FILAMENT

V_f 1.25 V I_f 15mA Suitable for D.C. operation only

Direct soldered connections to the leads of this valve must be at least 5 mm from the seal and any bending of the valve leads must be at least 1.5 mm from the seal

CAPACITANCES

C_{a-g1}	<0.2	$\mu\mu\text{F}$
C_{in}	2.5	$\mu\mu\text{F}$
C_{out}	3.7	$\mu\mu\text{F}$

CHARACTERISTICS

V_{a1}	22.5	V
V_{g2}	22.5	V
I_a	300	μA
I_{g2}	75	μA
V_{g1}	-1.4	V
ξ_m	350	$\mu\text{A/V}$
Γ_a	0.3	$\text{M}\Omega$
μ_{g1-g2}	8	

OPERATING CONDITIONS

As single valve Class "A" amplifier (screen fed direct from H.T. line)

V_b	22.5	V
V_{g2}	22.5	V
V_{g1}	-1.4	V
R_a	75	$\text{K}\Omega$
$I_{a(o)}$	300	μA
$I_{g2(o)}$	75	μA
$V_{1u(r,m,s)}$	0.85	V
P_{out}	2.7	mW
D_{tot}	10	%

LIMITING VALUES

V_a max.	45	V
V_{g2} max.	45	V
I_k max.	1.0	mA

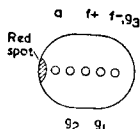

BASE:
Wired in
B5A

DIMENSIONS:
L=35 mm+32 mm leads
D=6.1 x 8.4 mm

Sub-miniature output pentode

DL 71

FILAMENT

V_f 1.25 V I_f 25 mA Suitable for D.C. operation only

Direct soldered connections to the leads of this valve must be at least 5 mm from the seal and any bending of the valve leads must be at least 1.5 mm from the seal

CAPACITANCES (Measured without an external screen)

C_{a-g1}	<0.5	$\mu\mu F$
C_{in}	2.6	$\mu\mu F$
C_{out}	3.6	$\mu\mu F$

CHARACTERISTICS

V_a	45	V
V_{g2}	45	V
V_{g1}	-1.25	V
I_a	600	μA
I_{g2}	150	μA
g_m	550	$\mu A/V$
r_a	0.35	M Ω
μ_{g1-g2}	15	

OPERATING CONDITIONS

As single valve Class "A" amplifier (screen fed direct from H.T. line)

V_b	45	V
$I_{a(o)}$	590	μA
$I_{g2(o)}$	150	μA
R_k	1.5	K Ω
V_{g1}	-1.25	V
R_a	0.1	M Ω
$V_{f(a,r,m,s)}$	0.88	V
P_{out}	6.3	mW
D_{tot}	10	%

Note.—For the above conditions the signal source impedance consisted of a 0.47 M Ω resistor in series with a capacitor of 0.1 μF , the combination being shunted by a 10 M Ω resistor

LIMITING VALUES

V_a max.	45	V
V_{g2} max.	45	V
I_k max.	1.7	mA

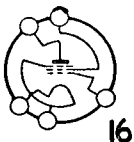

BASE:
Wired-in
B8D

DIMENSIONS:
L=38 mm plus 32 mm leads
D=10.1 mm



4 VALVE DATA PREFERRED TYPES

E OUTPUT PENTODES

DL72 Sub-miniature output pentode

FILAMENT

V_f 1.25 V I_f 25 mA Suitable for D.C. operation only

Direct soldered connections to the leads of this valve must be at least 5 mm from the seal and any bending must be at least 1.5 mm from the seal

CAPACITANCES (Measured without an external screen)

C_{in}	1.6	$\mu\mu\text{F}$
C_{out}	3.6	$\mu\mu\text{F}$
C_{a-g}	<0.5	$\mu\mu\text{F}$

CHARACTERISTICS

V_a	45	V
V_{g2}	45	V
V_{g1}	-4.5	V
I_a	1.25	mA
I_{g2}	0.4	mA
g_m	500	$\mu\text{A/V}$
r_a	0.17	M Ω

OPERATING CONDITIONS

As single valve Class "A" amplifier (screen fed direct from H.T. line)

V_b	45	V
R_k	2.7	K Ω
V_{g1}	-4.16	V
I_a	1.16	mA
I_{g2}	0.35	mA
R_a	30	K Ω
$V_{in(rms)}$ ($D_{tot}=10\%$)	2.65	V
P_{out} ($D_{tot}=10\%$)	19.5	mW

LIMITING VALUES

V_a max.	45	V
V_{g2} max.	45	V
I_k max.	1.7	mA



16

BASE:
Wired-in
B8D

DIMENSIONS:
L=38 mm plus 32 mm leads
D=10.1 mm



Miniature output pentode

DL92

FILAMENT Suitable for D.C. operation only

- (a) Series : V_f applied across the two filament sections in series, between pins 1 and 7. V_{g1} referred to pin 1
- (b) Parallel : V_f applied across the two filament sections in parallel, between pin 5 and pins 1 and 7 connected together. V_{g1} referred to pin 5

	<i>Series</i>	<i>Parallel</i>	
V_f	2.8	1.4	V
I_f	0.05	0.1	A

OPERATING CONDITIONS As Class "A" amplifier

Filament	<i>Series</i>		<i>Parallel</i>		
V_a	67.5	90	67.5	90	V
V_{g2}	67.5	67.5	67.5	67.5	V
V_{g1}	-7	-7	-7	-7	V
$I_{s(o)}$	6.0	6.1	7.2	7.4	mA
$I_{g2(o)}$	1.2	1.1	1.5	1.4	mA
g_m	1.4	1.43	1.55	1.58	mA/V
r_a	0.1	0.1	0.1	0.1	M Ω
R_a	5	8	5	8	K Ω
$V_{in(r.m.s.)}$	5	5	5	5	V
P_{out}	160	235	180	270	mW
D_{tot}	12	13	10	12	%

LIMITING VALUES

Filament	<i>Series</i>		<i>Parallel</i>		
V_a max.	90	90	90	90	V
V_{g2} max.	67.5	67.5	67.5	67.5	V
I_k (max. signal)	5.5*	5.5*	11.0	11.0	mA
$I_{k(o)}$ max.	4.5*	4.5*	9.0	9.0	mA

*For each 1.4 V section

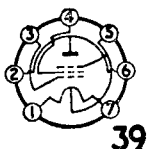

BASE :
B7G

DIMENSIONS :
L=54 mm
D=19 mm

39



4 VALVE DATA PREFERRED TYPES

E OUTPUT PENTODES

DL 93 Miniature output pentode

For operation in transmitting circuits see Section H, page 126

FILAMENT Suitable for D.C. operation only

(a) Series : V_f applied across the two filament sections in series, between pins 1 and 7. V_{g1} referred to pin 1.

(b) Parallel : V_f applied across the two filament sections in parallel, between pin 5 and pins 1 and 7 connected together. V_{g1} referred to pin 5.

	Series	Parallel
V_f	2.8	1.4
I_f	0.1	0.2

CAPACITANCES

Measured without external screen

C_{a-g1}	<0.34 $\mu\mu\text{F}$
C_{1n}	4.8 $\mu\mu\text{F}$
C_{out}	4.2 $\mu\mu\text{F}$

OPERATING CONDITIONS As Class "A" amplifier

Filament Arrangement	Parallel*		
V_a	135	150	V
V_{g2}	90	90	V
V_{g1}	-7.5	-8.4	V
$I_{a(o)}$	14.8	13.3	mA
$I_{g1(o)}$	2.6	2.2	mA
I_a (max. sig.)	14.9	14.1	mA
I_{g2} (max. sig.)	3.5	3.5	mA
r_a	90	100	K Ω
g_m	1.9	1.9	mA/V
R_a	8	8	K Ω
$V_{in(r, m, s.)}$	5.3	5.9	V
P_{out}	600	700	mW
D_{tot}	5	6	%

*Operation with series connected filament will be similar to that with parallel connection. With series connection a shunting resistor must be connected between pins 1 and 5 to by-pass the cathode current

LIMITING VALUES

As power amplifier

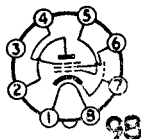

V_a max.	150	V
V_{g2} max.	90	V
p_a max.	2.0	W
p_{g2} max.	0.4	W
$I_{k(o)}$ max.	18	mA

BASE :
B7G

DIMENSIONS :

L=54 mm
D=19 mm

DL 94

Miniature output pentode

FILAMENT Suitable for D.C. operation only

- (a) Series : V_f applied across the two filament sections in series between pins 1 and 7. V_{g1} referred to pin 1
- (b) Parallel : V_f applied across the two filament sections in parallel between pin 5 and pins 1 and 7 connected together. V_{g1} referred to pin 5

	Series	Parallel	
V_f	2.8	1.4	V
I_f	0.05	0.1	A

CAPACITANCES Without external screening

C_{a-g1}	0.2	$\mu\mu\text{F}$
C_{in}	5.5	$\mu\mu\text{F}$
C_{out}	3.8	$\mu\mu\text{F}$

OPERATING CONDITIONS As Class "A" amplifier

Filament	Series	Parallel		
V_a	90	85	90	V
V_{g2}	90	85	90	V
V_{g1}	-4.5	-5.0	-4.5	V
$I_{a(o)}$	7.7	6.9	9.5	mA
$I_{g2(o)}$	1.7	1.5	2.1	mA
g_m	2.0	1.98	2.15	mA/V
r_a	0.12	0.12	0.1	M Ω
R_a	10	10	10	K Ω
$V_{in(r.m.s.)}$	3.2	3.5	3.2	V
P_{out}	240	250	270	mW
D_{tot}	7	10	7	%

LIMITING VALUES

Filament	Series	Parallel		
V_a max.	90	90	90	V
V_{g2} max.	90	90	90	V
$I_{k(o)}$ max.	6	12	12	mA
I_k max. (max. sig.)	6	12	12	mA

The limiting values of I_k for series operation given above indicate the maximum for each 1.4 V section of the filament. As the actual I_k max. of the valve is 12 mA, it is necessary to connect a resistor between pins 1 and 5 in order to maintain the correct voltage across the filament

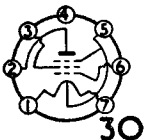

BASE :
B7G

DIMENSIONS :
L=54 mm
D=19 mm



4 VALVE DATA PREFERRED TYPES E OUTPUT PENTODES

EBL 21 Double diode output pentode

HEATER

V_h 6.3 V I_h 0.8 A Suitable for A.C. mains operation

CAPACITANCES

C_{a-g1}	<1.4	$\mu\mu\text{F}$
$C_{a'd-k}$	1.8	$\mu\mu\text{F}$
$C_{a'd-k}$	2.0	$\mu\mu\text{F}$
$C_{a'd-a'd}$	<0.15	$\mu\mu\text{F}$

OPERATING CONDITIONS

As Class "A" amplifier

V_a	250	250	V
V_{g2}	250	275	V
V_{g1}	-6.0	-6.2	V
I_a	36	44	mA
I_{g2}	4.5	5.8	mA
R_k	150	120	Ω
g_m	9.0	9.5	mA/V
μ_{g1-g2}	23	23	
r_a	50	50	K Ω
R_a	7	5.7	K Ω
P_{out}	4.5	5.5	W
D_{tot}	10	10	%
$V_{in(r,m,s)}$	4.2	4.5	V
$V_{in(r,m,s)}$ ($P_{out}=50$ mW)	0.35	0.3	V

OPERATING CONDITIONS

As Class "AB₁" push-pull pair

V_a	300	V
V_{g2}	300	V
R_k	120	Ω
$I_{a(o)}$	2×30	mA
I_a (max. sig.)	2×36	mA
$I_{g2(o)}$	2×3.8	mA
I_{g2} (max. sig.)	2×6.5	mA
R_{a-a}	9	K Ω
$V_{in(r,m,s)}$	2×7.0	V
P_{out}	13.2	W
D_{tot}	1.8	%
$V_{in(r,m,s)}$ ($P_{out}=50$ mW)	2×0.3	V

LIMITING VALUES

$V_{a(b)}$ max.	550	V
V_a max.	300	V
p_a max.	11	W
$V_{g2(b)}$ max.	550	V
V_{g2} max.	300	V
p_{g2} max.	3.5	W
I_k max.	60	mA
R_{g1-k} max.	1.0	M Ω
V_{h-k} max.	50	V



LIMITING VALUES (contd.)

V_{a-d} max.	200	V
V_{s-d} max.	200	V
I_{s-d} max.	0.8	mA
I_{b-d} max.	0.8	mA
V_{s-d} max. ($I_{b-d} = +0.3 \mu A$)	-1.3	V
V_{a-d} max. ($I_{s-d} = +0.3 \mu A$)	-1.3	V

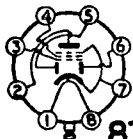

87

BASE :
B8G

DIMENSIONS :
L=96 mm
D=29 mm

EBL 21
(contd.)

Double diode output pentode

EBL 31

HEATER

V_h 6.3 V I_h 1.2 A Suitable for A.C. mains operation

CAPACITANCES

$C_{a-d-a-d}$	<0.35	$\mu\mu F$
C_{a-d-k}	3.0	$\mu\mu F$
C_{s-d-k}	3.6	$\mu\mu F$

OPERATING CONDITIONS

As Class "A" amplifier

V_a	250	V
V_{g2}	250	V
I_a	36	mA
R_k	150	Ω
V_{g1}	-6.0	V
I_{g2}	5.0	mA
g_m	9.5	mA/V
r_a	55	K Ω
R_s	7	K Ω
P_{out}	4.3	W
D_{tot}	10	%
$V_{in(r, m, s.)}$	3.6	V
$V_{in(r, m, s.)}$ ($P_{out} = 50$ mW)	0.35	V

LIMITING VALUES

$V_{a(b)}$	550	V
V_a max.	250	V
p_a max.	9	W
I_k max.	55	mA
$V_{g2(b)}$ max.	550	V
V_{g2} max.	250	V
p_{g2} max.	1.5	W
R_{g1-k} max.	1	M Ω
V_{h-k} max.	50	V



4 VALVE DATA PREFERRED TYPES

E OUTPUT PENTODES

EBL 31 (contd.)

LIMITING VALUES (contd.)

V_{a-d} max.	200	V
V_{g1-d} max.	200	V
I_{a-d} max.	0.8	mA
I_{g1-d} max.	0.8	mA
V_{a-d} max. ($I_{a-d} = +0.3 \mu A$)	-1.3	V
V_{g1-d} max. ($I_{a-d} = +0.3 \mu A$)	-1.3	V

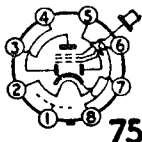

BASE :
Octal

DIMENSIONS :
L=136 mm
D=46 mm

ECL 80

Triode-pentode primarily intended for use as combined line oscillator and frame output valve in television receivers

HEATER

V_h 6.3 V I_h 0.3 A Suitable for series or parallel operation

CAPACITANCES

	C_{gt-sp}	<0.02	$\mu\mu F$
	C_{gt-g1}	<0.2	$\mu\mu F$
	C_{at-sp}	<1.2	$\mu\mu F$
	C_{at-g1}	<0.2	$\mu\mu F$
Triode Section	C_{gt-k}	2.0	$\mu\mu F$
	C_{a-k}	0.3	$\mu\mu F$
	C_{a-gt}	0.9	$\mu\mu F$
Pentode Section	C_{gt-h}	<0.05	$\mu\mu F$
	C_{in}	4.5	$\mu\mu F$
	C_{out}	5.0	$\mu\mu F$
	C_{a-g1}	<0.2	$\mu\mu F$
	C_{g1-h}	<0.25	$\mu\mu F$

CHARACTERISTICS

Triode Section

V_a	100	V
V_{gt}	-2.3	V
I_a	4	mA
g_m	1.4	mA/V
r_a	12.5	K
μ	17.5	

Pentode Section

V_a	170	200	V
V_{g2}	170	200	V
V_{g3}	0	0	
V_{g1}	-6.7	-8.0	V
I_a	15	17.5	mA
I_{g2}	2.8	3.3	mA
g_m	3.4	3.5	mA/V
r_a	0.15	0.15	M Ω
μ_{g1-g2}	14	14	



OPERATING CONDITIONS OF TRIODE SECTION

As A.F. voltage amplifier

V_b	170	200	V
R_a	0.22	0.22	M Ω
* R_{g1}	0.68	0.68	M Ω
V_{gt}	-3.5	-4.2	V
I_{at}	0.45	0.55	mA
V_{out}/V_{in}	11.5	11.5	
$V_{out(r.m.s.)}$ ($D_{tot}=5\%$)	20	24	V

*Grid resistance of following valve

ECL 80
(contd.)

OPERATING CONDITIONS OF PENTODE SECTION

As audio output valve

V_a	170	200	V
V_{g2}	170	200	V
V_{g3}	0	0	V
V_{g1}	-6.7	-8.0	V
$I_{a(o)}$	15	17.5	mA
$I_{g2(o)}$	2.8	3.3	mA
R_a	11	11	K Ω
$V_{in(r.m.s.)}$ ($P_{out}=50$ mW)	0.7	0.7	V
P_{out}	1.0	1.4	W
$V_{in(r.m.s.)}$	3.5	4.0	V
D_{tot}	10	10	%

LIMITING VALUES

Triode Section

$V_{a(b)}$ max.	550	V
V_a max.	200	V
p_a max.	1	W
I_k max.	6	mA
V_{gt} max. ($I_{gt}=+0.3$ μ A)	-1.3	V
R_{gt-k} max.	3	M Ω
V_{h-k} max.	150	V

Pentode Section

$V_{a(b)}$ max.	550	V
V_a max.	400	V
$V_{a(pk)}$ max.	1,200	V
p_a max.	3.5	W
$V_{g2(b)}$ max.	550	V
V_{g2} max.	250	V
p_{g2} max.	0.75	W
I_k max.	25	mA
V_{g1} max. ($I_{g1}=+0.3$ μ A)	-1.3	V
* R_{g1-k} max. ($I_k=20$ mA)	1	M Ω
† R_{g1-k} max. ($I_k=12$ mA)	2.2	M Ω
V_{h-k} max.	150	V

*As audio output valve
†As frame output valve



BASE:
B9A
(Noval)

DIMENSIONS:
L=67 mm
D=22.2 mm



4 VALVE DATA PREFERRED TYPES

E OUTPUT PENTODES

EL 31 Output pentode rated for a continuous anode dissipation of 25 W

HEATER

V_h 6.3 V I_h 1.4 A Suitable for A.C. mains operation

CAPACITANCE

C_{a-g1} 1.2 μF

CHARACTERISTICS

V_a	275	600	V
V_{g2}	275	400	V
V_{g1}	-9	-22	V
I_a	91	42	mA
I_{g2}	11	5	mA
g_m	14	7.0	mA/V
r_a	20	43	K Ω
μ_{g1-g2}	16.5	—	

OPERATING CONDITIONS

As push-pull pair (self bias)

V_a	350	375	400	V
V_{g2}	350	375	400	V
R_k	100	122	145	Ω
$I_{a(0)}$	2×71	2×67	2×63	mA
I_a (max. sig.)	2×83	2×75	2×69	mA
$I_{g2(0)}$	2×8.8	2×8.8	2×8.3	mA
I_{g2} (max. sig.)	2×23.5	2×24.5	2×24	mA
R_{a-a}	5	6	7	K Ω
$V_{in(r,m,s)}$	2×15	2×15	2×15.5	V
* P_{out}	38	37.5	37	W
D_{tot}	4.2	5.0	5.0	%

*Measured at start of I_{g1} or 5% distortion

OPERATING CONDITIONS

As push-pull pair (fixed bias)

V_a	400	600	800	V
V_{g2}	400	400	400	V
V_{g1}	-23	-25.2	-26	V
$I_{a(0)}$	2×40	2×30	2×30	mA
I_a (max. sig.)	2×110	2×103	2×107	mA
$I_{g2(0)}$	2×5.2	2×3.4	2×3.1	mA
I_{g2} (max. sig.)	2×26.8	2×28.5	2×28.5	mA
R_{a-a}	4	7.5	10	K Ω
$V_{in(r,m,s)}$	2×15.5	2×17.5	2×18	V
* P_{out}	55	84	120	W
D_{tot}	3.2	5.0	5.0	%

*Measured at start of I_{g1} or 5% distortion.



LIMITING VALUES

$V_{a(b)}$ max.	1,200	V
V_a max.	800	V
$V_{g2(b)}$ max.	800	V
V_{g2} max.	400	V
p_a max.	25	W
p_{g2} max.	8	W
I_k max.	200	mA
V_{h-k} max.	100	V
R_{g1-k} max. (self bias)	0.5	M Ω
R_{g1-k} max. (fixed bias)	0.1	M Ω

EL 31
(contd.)



73

BASE :
Octal

DIMENSIONS :
L=141 mm
D=54 mm

Output pentode

EL 32

HEATER

V_h 6.3 V I_h 0.2 A Suitable for series or parallel operation, D.C. or A.C.

OPERATING CONDITIONS

As Class "A" amplifier

V_a	250	V
V_{g2}	250	V
V_{g1}	-18	V
I_a	32	mA
I_{g2}	5	mA
g_m	2.8	mA/V
r_a	70	K Ω
R_a	8	K Ω
P_{out}	3.6	W
$V_{in(r,m,s)}$	10	V
D_{tot}	10	%

OPERATING CONDITIONS

As push-pull pair (self bias)

V_a	200	250	V
V_{g2}	200	250	V
R_k	330	330	Ω
$I_{a(o)}$	2×21	2×27.5	mA
I_a (max. sig.)	2×24.5	2×32	mA
$I_{g2(o)}$	2×3.85	2×4.4	mA
I_{g2} (max. sig.)	2×6.1	2×8.0	mA
R_{a-a}	9	8	K Ω
P_{out}	5.1	7	W
D_{tot}	1.6	1.5	%



4 VALVE DATA PREFERRED TYPES

E OUTPUT PENTODES

EL 32 contd.)

OPERATING CONDITIONS AS TRIODE

Screen connected to anode

V_a	200	200	250	250	V
V_{g1}	-19	-14	-27	-20	V
I_a	15	30	15	30	mA
g_m	2.1	3.2	1.7	2.6	mA/V
r_a	3.3	2.4	4.1	3.1	K Ω
μ	7	8	7	8	

LIMITING VALUES

$V_{a(b)}$ max.	550	V
V_a max.	250	V
p_a max.	8	W
I_k max.	45	mA
$V_{g2(b)}$ max.	550	V
V_{g2} max.	250	V
p_{g2} max.	1.6	W
R_{g1-k} max. (fixed bias)	0.6	M Ω
R_{g1-k} max. (self bias)	1.0	M Ω
V_{h-k} max.	50	V



71

BASE :
Octal

DIMENSIONS :
L=110 mm
D=37 mm

EL 33 Output pentode

HEATER

V_h 6.3 V I_h 0.9 A Suitable for A.C. mains operation

CAPACITANCE

C_{a-g1}	1.0	$\mu\mu\text{F}$
------------	-----	------------------

OPERATING CONDITIONS

As Class "A" amplifier

V_a	250	V
V_{g2}	250	V
I_a	36	mA
V_{g1}	-6	V
I_{g2}	4	mA
g_m	9	mA/V
r_a	50	K Ω
μ_{g1-g2}	23	
P_{out}	4.5	W
R_a	7	K Ω
$V_{in(r,m,s)}$	4.2	V
$V_{in(r,m,s)}$ ($P_{out}=50$ mW)	0.33	V
D_{tot}	10	%
R_k	150	Ω

OPERATING CONDITIONS (contd.)

EL 33
(contd.)

As push-pull pair (self bias)

V_a	250	V
V_{g2}	250	V
$I_{a(0)}$	2×24	mA
I_a (max. sig.)	2×28.5	mA
$I_{g2(0)}$	2×2.8	mA
I_{g2} (max. sig.)	2×4.6	mA
R_k	150	Ω
R_{a-a}	10	K Ω
P_{out}	8.2	W
$V_{in(r,m,s)}$	6.7	V
D_{tot}	3.1	%

OPERATING CONDITIONS As Triode

Screen connected to anode

V_a	250	V
I_a	20	mA
V_g	-8.5	V
g_m	6.5	mA/V
μ	20	
r_a	3	K Ω
R_k	390	Ω
R_a	7	K Ω
P_{out}	1.1	W
D_{tot}	5	%
$V_{in(r,m,s)}$	5.9	V
$V_{in(r,m,s)} (P_{out}=50 \text{ mW})$	1.1	V

LIMITING VALUES

$V_{a(b)}$ max.	550	V
V_a max.	250	V
p_a max.	9	W
$V_{g2(b)}$ max.	550	V
V_{g2} max.	275	V
$p_{g2(0)}$ max.	1.2	W
p_{g2} (max. sig.) max.	2.5	W
I_k max.	55	mA
R_{g1-k} max.	1	M Ω
V_{h-k} max.	50	V



BASE :
Octal

DIMENSIONS :
L=126 mm
D=46 mm

Output pentode

EL 37

HEATER

V_h 6.3 V I_h 1.4 A Suitable for A.C. mains operation

CAPACITANCES

C_{out}	9.0	$\mu\mu\text{F}$
C_{1a}	17.5	$\mu\mu\text{F}$
C_{a-g1}	1.0	$\mu\mu\text{F}$



4 VALVE DATA PREFERRED TYPES E OUTPUT PENTODES

EL 37 OPERATING CONDITIONS (contd.) As Class "A" amplifier

V_a	250	V
V_{g2}	250	V
V_{g1}	-13.5	V
I_a	100	mA
I_{g2}	13.5	mA
R_k	120	Ω
g_m	11.0	mA/V
r_a	13.5	K Ω
μ_{g1-g2}	10	
R_a	2.5	K Ω
$V_{in(r,m,s.)}$ ($P_{out}=50$ mW)	0.45	V
P_{out} ($D_{tot}=10\%$)	10.5	W
$V_{in(r,m,s.)}$ (start of I_{g1})	10.8	V
D_{tot} (start of I_{g1})	13.5	%
P_{out} (start of I_{g1})	11.5	W

As push-pull pair (self bias)

V_a	250	325	V
V_{g2}	250	325	V
$I_{a(o)}$	2 \times 59	2 \times 77	mA
I_a (max. sig.)	2 \times 68	2 \times 90	mA
$I_{g2(o)}$	2 \times 7.5	2 \times 9.75	mA
I_{g2} (max. sig.)	2 \times 18	2 \times 30	mA
R_k	130	130	Ω
R_{a-a}	4	4	K Ω
P_{out}	20	35	W
$V_{in(r,m,s.)}$	2 \times 14.5	2 \times 21.5	V
D_{tot}	2.3	4.4	%

As push-pull pair (fixed bias)

V_a	350	400	V
V_{g2}	350	400	V
$I_{a(o)}$	2 \times 40	2 \times 50	mA
I_a (max. sig.)	2 \times 118	2 \times 138	mA
$I_{g2(o)}$	2 \times 5	2 \times 6	mA
I_{g2} (max. sig.)	2 \times 29	2 \times 36	mA
V_{g1}	-31	-36	V
R_{a-a}	3.25	3.25	K Ω
P_{out}	46	69	W
$V_{in(r,m,s.)}$	2 \times 21.7	2 \times 24.5	V
D_{tot}	2.8	2.5	%

OPERATING CONDITIONS AS TRIODE

Single valve (screen connected to anode by 100 Ω resistor)

V_a	300	400	V
I_a	50	37.5	mA
V_{g1}	-26	-39	V
g_m	6.5	4.5	mA/V
μ	9	9	
r_a	1.4	2	K Ω

VALVE DATA
PREFERRED TYPES **4**
OUTPUT PENTODES **E**

OPERATING CONDITIONS AS TRIODE (contd.)

EL 37
(contd.)

As triode connected push-pull pair (self bias)

V_b	350	435	V
V_a	320	400	V
I_a (0)	2×56	2×70	mA
I_a (max. sig.)	2×64	2×80	mA
p_a	2×18	2×28	W
R_k	245	245	Ω
R_{a-a}	4	4	K Ω
V_{in} (r.m.s.)	2×21.5	2×27.2	V
P_{out}	12.5	20.6	W
D_{tot}	4.1	4.3	%

LIMITING VALUES

$V_{a(b)}$ max.	800	V
V_a max.	400	V
$V_{g2(b)}$ max.	800	V
V_{g2} max.	400	V
V_{h-k} max.	75	V
R_{g1-k} max. (cathode bias)	0.5	M Ω
R_{g1-k} max. (fixed bias)	0.1	M Ω
p_a max.	25	W
p_{g2} max.	6	W
I_k max.	200	mA



BASE :
Octal

DIMENSIONS :
L=131 mm
D=54 mm

Output pentode, for use as line time base output valve in A.C. television receivers. Type EL 38M is metallised

EL 38
EL 38M

HEATER

V_h 6.3 V I_h 1.4 A Suitable for A.C. mains operation

CAPACITANCES

	EL 38M	EL 38	
C_{in}	18	18	$\mu\mu\text{F}$
C_{out}	9.5	6.5	$\mu\mu\text{F}$
C_{a-g1}	<1.0	<1.2	$\mu\mu\text{F}$

CHARACTERISTICS

V_a	275	V
V_{g2}	275	V
I_a	91	mA
I_{g2}	11	mA
V_{g1}	-9	V
g_m	14	mA/V
μ_{g1-g2}	16.5	
r_a	20	K Ω



4 VALVE DATA PREFERRED TYPES

E OUTPUT PENTODES

EL 38
EL 38M
(contd.)

OPERATING CONDITIONS

As line time base output valve (see Fig. 1, below)

	V_b	300	V
For EL 38	I_a	64	mA
	I_{g2}	18	mA
	R_k	120	Ω
For EBC 33	I_a	0.8	mA

N.B.—Above values measured under synchronised conditions

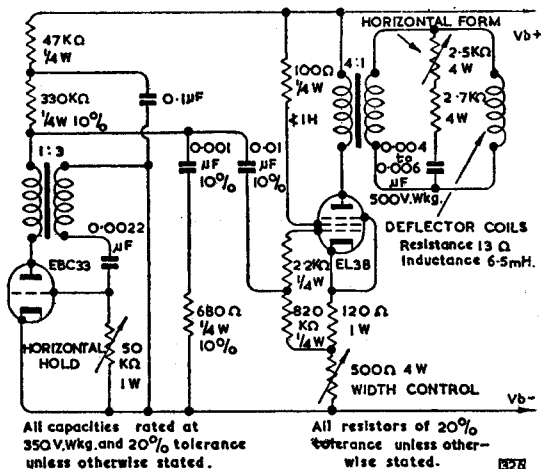

Fig. 1.—Line time base circuit.

NOTES:

- (1) The deflector coils should be capable of providing full scan for MW22-17 ($V_a=7KV$) with a peak to peak current swing of 500mA.
- (2) Synchronising pulses may be applied negatively to the anode or positively to the grid of the EBC.33.
- (3) The decoupling components (47K Ω and 0.1 μF) in the anode circuit of the EBC.33 are necessary only if there is ripple on the H.T. line.
- (4) All potentiometers should be linear components to provide smooth control.

LIMITING VALUES



EL 38
BASE:
Octal

V_a max.	800	V
V_a (pk) max.	8	KV
V_{g2} max.	400	V
p_a max.	25	W
p_{g2} max.	8	W
I_k max.	200	mA
R_{g1-k} ($p_a < 25$ W) max.	0.5	M Ω
R_{g1-k} ($p_a < 9$ W) max.	0.8	M Ω
V_{b-k} max.	100	V



EL38M
BASE:
Octal

DIMENSIONS:

L=141 mm
D=45.5 mm

EL 41

Output pentode.

HEATER

V_h 6.3 V I_h 0.7 A Suitable for A.C. mains operation

CAPACITANCES

C_{in}	10.2	$\mu\mu F$
C_{out}	7.8	$\mu\mu F$
C_{g1-g2}	<1.0	$\mu\mu F$

OPERATING CONDITIONS

As single Class "A" amplifier

V_a	250	V
V_{g2}	250	V
R_k	180	Ω
V_{g1}	-7	V
I_a	36	mA
I_{g2}	5.2	mA
g_m	10	mA/V
r_a	40	K Ω
μ_{g1-g2}	22	
R_a	7	K Ω
$V_{in(r.m.s.)}$ ($P_{out}=50$ mW)	0.32	V
P_{out} ($D_{tot}=10\%$)	4.2	W
$V_{in(r.m.s.)}$ ($D_{tot}=10\%$)	3.7	V
P_{out} ($\eta=50\%$)	4.5	W
$V_{in(r.m.s.)}$ ($P_{out}=4.5$ W)	4.0	V
D_{tot} ($P_{out}=4.5$ W)	11.5	%

LIMITING VALUES

$V_{a(b)}$ max.	550	V
V_a max.	300	V
p_a max.	9	W
$V_{g2(b)}$ max.	550	V
V_{g2} max.	300	V
p_{g2} (zero sig.) max.	1.4	W
p_{g2} (max. sig.) max.	3.3	W
I_k max.	55	mA
R_{g1-k} max.	1	M Ω
V_{b-k} max.	50	V



BASE :
B8A

DIMENSIONS :
L=80 mm
D=22 mm

Output pentode, particularly suitable for use in car radio receivers

EL 42

HEATER

V_h 6.3 V I_h 0.2 A Suitable for D.C./A.C. operation

CAPACITANCE

C_{g1-g2}	<0.2	$\mu\mu F$
-------------	------	------------



4 VALVE DATA PREFERRED TYPES E OUTPUT PENTODES

EL 42 (contd.)

OPERATING CONDITIONS

As single Class "A" amplifier

V_a	200	225	V
V_{g2}	200	225	V
R_k	360	360	Ω
I_a	22.5	26	mA
I_{g2}	3.5	4.1	mA
g_m	3.2	3.2	mA/V
r_a	90	90	K Ω
μ_{g1-g2}	11	11	
R_a	9	9	K Ω
$V_{in(rms)}$ ($P_{out}=50mW$)	0.8	0.75	V
$V_{in(rms)}$	6.5	7.2	V
P_{out}	1.9	2.5	W
D_{tot}	10	10	%

As Class "AB" push-pull pair (self bias)

V_a	200	250	V
V_{g2}	200	250	V
R_k	310	310	Ω
$I_{a(o)}$	2×16	2×20	mA
I_a (max. sig.)	2×17	2×21.5	mA
$I_{g2(o)}$	2×2.6	2×3.2	mA
I_{g2} (max. sig.)	2×5.6	2×6.7	mA
R_{a-a}	15	15	K Ω
$V_{in(rms)}$ ($P_{out}=50mW$)	2×0.75	2×0.7	V
$V_{in(rms)}$	2×9.6	2×12.5	V
P_{out}	4.1	7.0	W
D_{tot}	5.5	5.5	%

As Class "B" push-pull pair (fixed bias)

V_a	200	250	V
V_{g2}	200	250	V
V_{g1}	-17	-22.5	V
$I_{a(o)}$	2×5	2×5	mA
I_a (max. sig.)	2×16	2×20	mA
$I_{g2(o)}$	2×0.8	2×0.8	mA
I_{g2} (max. sig.)	2×4.6	2×6.5	mA
R_{a-a}	16	16	K Ω
$V_{in(rms)}$ ($P_{out}=50mW$)	2×1.5	2×1.7	V
$V_{in(rms)}$	2×12	2×16	V
P_{out}	4.0	6.5	W
D_{tot}	3.5	5	%

LIMITING VALUES

$V_{a(b)}$	550	V
V_a max.	300	V
p_a max.	6	W
$V_{g2(b)}$ max.	550	V
V_{g2} max.	300	V
$p_{g2(o)}$ max.	1.0	W
p_{g2} max. (max. sig.)	2.0	W
I_k max.	35	mA
R_{g1-k} max.	2.0	M Ω
V_{b-k} max.	50	V

BASE :

B8A

DIMENSIONS :

L=60 mm

D=22 mm

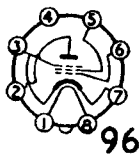

96



Miniature output pentode

EL 91

HEATER

V_h 6.3 V I_h 0.2 A Suitable for series or parallel operation.

CAPACITANCES

C_{in}	4.2	$\mu\mu F$
C_{out}	3.2	$\mu\mu F$
C_{a-g_1}	<0.5	$\mu\mu F$

OPERATING CONDITIONS

As single valve Class "A" amplifier

V_a	250	V
V_{g_2}	250	V
I_a	16	mA
I_{g_2}	2.4	mA
g_m	2.6	mA/V
$\mu_{g_1-g_2}$	12	
r_a	130	K Ω
R_k	680	Ω
R_a	16	K Ω
$V_{in(rms)}$	5.3	V
P_{out}	1.4	W
D_{tot}	10	%

As push-pull pair (self bias)

V_a	250	V
V_{g_2}	250	V
$I_{a(0)}$	2×11	mA
$I_{g_2(0)}$	2×1.6	mA
R_k	600	Ω
R_{a-a}	24	K Ω
$V_{in(rms)}$ ($P_{out}=50$ mW)	2×0.8	V
I_a (max. sig.)	2×12.8	mA
I_{g_2} (max. sig.)	2×4.1	mA
$V_{in(rms)}$	2×12	V
P_{out}	4.0	W
D_{tot}	3.2	%

As push-pull pair (fixed bias)

V_a	250	V
V_{g_2}	250	V
V_{g_1}	-19	V
$I_{a(0)}$	2×5	mA
$I_{g_2(0)}$	2×0.65	mA
R_{a-a}	20	K Ω
$V_{in(rms)}$ ($P_{out}=50$ mW)	2×1.5	V
I_a (max. sig.)	2×16	mA
I_{g_2} (max. sig.)	2×4.5	mA
$V_{in(rms)}$	2×13	V
P_{out} (start of I_{g_1})	4.8	W
D_{tot} (start of I_{g_1})	3.3	%



4 VALVE DATA PREFERRED TYPES

E OUTPUT PENTODES

EL 91 LIMITING VALUES

(contd.)



V_a max.	250	V
V_{g2} max.	250	V
p_a max.	4.0	W
P_{g2} max.	0.6	W
I_k max.	25	mA
V_{b-k} max.	50	V
R_{g1-k} max. (cathode bias)	0.7	M Ω

BASE :
B7G

DIMENSIONS :
L=54 mm
D=19 mm

KL 35 Output pentode

FILAMENT

V_f 2.0 V I_f 0.15 A Suitable for D.C. operation only

CHARACTERISTICS

V_a	135	V
V_{g2}	135	V
I_a	5.6	mA
g_m	2.2	mA/V
r_s	0.15	M Ω

OPERATING CONDITIONS

As single Class "A" amplifier

	Fixed bias	Self bias	
V_a	135	135	V
V_{g2}	135	135	V
V_{g1}	-4.5	-4.8	V
I_a	5.6	5.0	mA
R_a	19	20	K Ω
$V_{1D}(r, m, \theta, \dots)$	3.0	2.9	V
P_{out}	340	310	mW
D_{tot}	10	10	%

LIMITING VALUES

V_a max.	150	V
p_a max.	1.0	W
V_{g2} max.	150	V
I_k max.	10	mA
R_{g1-r} (fixed bias) max.	1.0	M Ω
R_{g1-r} (self bias) max.	1.5	M Ω
* V_{g1} ($I_{g1} = +1 \mu A$)	+0.3 to +0.8	V
*At $V_a = V_{g2} = 135$ V		



BASE:
Octal

DIMENSIONS:
L=106 mm
D=41 mm

KLL 32 Double output pentode

FILAMENT

V_f 2.0 V I_f 0.3 A Suitable for D.C. operation only



VALVE DATA
PREFERRED TYPES **4**
OUTPUT PENTODES **E**

CHARACTERISTICS

V_a	100	V
V_{g2}	100	V
V_{g1}	0	V
g_m	2.6	mA/V

KLL 32
(contd.)

OPERATING CONDITIONS

V_a	90	120	135	V
V_{g2}	90	120	135	V
$I_{a(0)}$	2.8	3.3	3.8	mA
I_a (max. sig.)	9.8	14.4	16.9	mA
V_{g1}	-7.4	-10.2	-11.3	V
I_{g2} (max. sig.)	2.8	4.6	5.7	mA
V_{in} (r. m. s.)	5.2	7.3	8.4	V
P_{out}	0.45	0.94	1.2	W
D_{tot}	1.8	2.5	2.8	%
R_{a-a}	16	16	16	K Ω



BASE:
Octal

DIMENSIONS:
L=101 mm
D=41 mm

Output pentode. Suitable for use in frame time base or audio output stage of series operated television receivers

PL 33

HEATER

V_b 19 V I_b 0.3 A Suitable for series operation, D.C. or A.C.

CAPACITANCE

C_{a-g1} 1.0 $\mu\mu\text{F}$

OPERATING CONDITIONS

As single Class "A" amplifier

V_a	175	200	225	V
V_{g2}	175	200	225	V
R_k	150	150	150	Ω
V_{g1}	-4	-4.65	-5.3	V
I_a	24	28	32	mA
I_{g2}	2.6	3.0	3.4	mA
g_m	8	8.6	9	mA/V
r_a	60	55	50	K Ω
μ_{g1-g2}	23	23	23	
R_a	7	7	7	K Ω
V_{in} (r. m. s.) ($D_{tot}=10\%$)	—	—	3.4	V
P_{out} ($D_{tot}=10\%$)	—	—	3.3	W
V_{in} (r. m. s.) (start of I_{g1})	2.6	3.1	3.6	V
P_{out} (start of I_{g1})	1.8	2.55	3.45	W
D_{tot} (start of I_{g1})	8.8	10	11	%



4 VALVE DATA PREFERRED TYPES

E OUTPUT PENTODES

PL 33 LIMITING VALUES

(contd.)

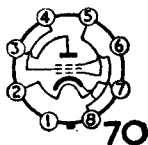

$V_{a(b)}$ max.	550	V
V_a max.	250	V
p_a max.	9	W
$V_{g2(b)}$ max.	550	V
V_{g2} max.	275	V
$P_{g2(o)}$ max.	1.2	W
P_{g2} (max. sig.) max.	2.5	W
I_k max.	55	mA
R_{g1-k} max. (self bias)	1.0	M Ω
V_{h-k} max.	300	V

BASE:
Octal

DIMENSIONS:
L=126 mm
D=46 mm

PL 38 Output pentode. Suitable for use as line time base output valve in series operated television receivers. **PL38M** is metallised

PL 38M

HEATER

V_h 30 V I_h 0.3 A Suitable for series operation, D.C. or A.C.

CAPACITANCES

	PL38M	PL38	
C_{in}	18	18	$\mu\mu F$
C_{out}	9.5	6.5	$\mu\mu F$
C_{a-g1}	<1.0	<1.2	$\mu\mu F$

CHARACTERISTICS

V_a	200	V
V_{g2}	200	V
V_{g1}	-5.5	V
I_a	75	mA
I_{g2}	9.0	mA
g_m	13.5	mA/V
r_a	20	K Ω
μ_{g1-g2}	16.5	

LIMITING VALUES

V_a max.	800	V
$V_{a(pk)}$ max.	8	KV
V_{g2} max.	400	V
p_a max.	25	W
P_{g2} max.	8	W
I_k max.	200	mA
R_{g1-k} max. ($p_a < 25$ W)	0.5	M Ω^*
R_{g1-k} max. ($p_a < 9$ W)	0.8	M Ω^*
V_{h-k} max.	200	V

BASE: *For self bias operation
 PL 38
 Octal (73)
 PL 38M
 Octal (101)

DIMENSIONS:
 L=141 mm
 D=45.5 mm

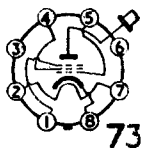

73



101



Double diode output pentode

UBL 21

FILAMENT

V_b 55 V $I_b=0.1$ A Suitable for series operation, D.C. or A.C.

CAPACITANCES

C_{a-g1}	< 1.2	$\mu\mu F$
$C_{a'd-k}$	1.8	$\mu\mu F$
$C_{a''d-k}$	2.0	$\mu\mu F$
$C_{a'd-a''d}$	< 0.15	$\mu\mu F$

OPERATING CONDITIONS

As Class "A" amplifier

V_a	100	180	200	V
V_{g3}	100	180	200	V
R_k	140	140	200	Ω
V_{g1}	-5.3	-10	-13	V
I_a	32.5	61	55	mA
I_{g3}	5.5	10	9.5	mA
g_m	7.5	9.0	8.0	mA/V
r_a	25	22	25	K Ω
μ_{g1-g3}	9.0	9.0	9.0	
R_a	3	3	3.5	K Ω
$V_{in (rms)} (P_{out}=50 mW)$	0.55	0.5	0.5	V
$P_{out} (D_{tot}=10\%)$	1.35	4.8	4.8	W
$V_{in (rms)} (D_{tot}=10\%)$	3.8	6.2	6.2	V

LIMITING VALUES

$V_{a(b)}$ max.	550	V
V_a max.	250	V
p_a max.	11	W
$V_{g3(b)}$ max.	550	V
V_{g3} max.	250	V
p_{g3} max. (max. sig.)	3.5	W
p_{g3} max. (zero sig.)	1.9	W
I_k max.	75	mA
R_{g1-k} max.	1.0	M Ω
V_{h-k} max.	150	V
$V_{a'd}$ max.	200	V
$V_{a''d}$ max.	200	V
$I_{a'd}$ max.	0.8	mA
$I_{a''d}$ max.	0.8	mA



BASE :
B8G

DIMENSIONS :
L=96 mm
D=29 mm



4 VALVE DATA E PREFERRED TYPES E OUTPUT PENTODES

UL 41 Output pentode

HEATER

V_h 45 V I_h 0.1 A Suitable for D.C./A.C. operation

CAPACITANCES

C_{out}	8.3	$\mu\mu F$
C_{in}	11.0	$\mu\mu F$
C_{g1-g2}	<1.0	$\mu\mu F$

OPERATING CONDITIONS

As single valve Class "A" amplifier

V_a	100	170	200	V
V_{g2}	100	170	200	V
V_{g1}	-5.7	-10.4	-14.2	V
R_k	165	165	270	Ω
I_a	29	53	45	mA
I_{g2}	5.5	10	8.5	mA
g_m	8.0	9.5	8.2	mA/V
r_a	18,000	20,000	24,000	Ω
μ_{g1-g2}	10	10	10	
R_{g1}	3,000	3,000	4,300	Ω
P_{out}	1.35	4.2	4.2	W
$V_{in (r.m.s.)}$	3.75	6.0	6.3	V
D_{tot}	10	10	10	%
$V_{in (r.m.s.)}$ ($P_{out}=50$ mW)	0.55	0.5	0.54	V

OPERATING CONDITIONS

For two valves in push-pull

V_a	100	170	200	V
V_{g2}	100	170	200	V
$I_a(0)$	2×24	2×44	2×45	mA
I_a (max. sig.)	2×27	2×49	2×53	mA
$I_{g2(0)}$	2×4.6	2×8.8	2×9	mA
I_{g2} (max. sig.)	2×6.8	2×16.5	2×19	mA
R_k	100	100	130	Ω
R_{g1-g2}	4,000	4,000	4,000	Ω
P_{out}	2.2	9.0	12.5	W
$V_{in (g-g)} (r.m.s.)$	9.2	18.6	24.5	V
D_{tot}	3.5	4.0	4.0	%



LIMITING VALUES

$V_{a(b)}$ max.	550	V
V_a max.	250	V
p_a max.	9	W
$V_{gs(b)}$ max.	550	V
V_{gs} max.	250	V
p_{gs} max.	1.75	W
p_{gs} (max. sig.)	4	W
I_k max.	75	mA
R_{g1-k} max.	1	M Ω
R_{h-k} max.	20	K Ω
V_{b-k} max.	150	V

UL 41
(contd.)



96

BASE :
B8A

DIMENSIONS :
L=76 mm
D=22 mm

RECTIFIERS

POWER RECTIFIERS FOR A.C. MAINS EQUIPMENT

Type	Description	V_h or V_r (V)	I_h or I_r (A)	Base	Page
AZ31	Full wave, directly heated	4.0	1.1	Octal	112
EY91	Half wave, indirectly heated	6.3	0.42	B7G	114
EZ35	Full wave, indirectly heated	6.3	0.6	Octal	115
EZ40	Full wave, indirectly heated	6.3	0.6	B8A	115
EZ41	Full wave, indirectly heated	6.3	0.4	B8A	116
FW4-500	Full wave, directly heated	4.0	3.0	4-pin	116
GZ32	Full wave, indirectly heated	5.0	2.0	Octal	118

POWER RECTIFIERS FOR D.C./A.C. MAINS EQUIPMENT

Type	Description	V_h (V)	I_h (A)	Base	Page
CY31	Half wave, indirectly heated	20	0.2	Octal	112
PY31	Half wave, indirectly heated	17	0.3	Octal	118
PZ30	Full wave, indirectly heated	52	0.3	Octal	119
UY21	Half wave, indirectly heated	50	0.1	B8G (Loctal)	120
UY41	Half wave, indirectly heated	31	0.1	B8A	121

HIGH VOLTAGE RECTIFIERS

Type	Description	V_h (V)	I_h (A)	Base	Page
EY51	Half wave, indirectly heated	6.3	0.09	B2A wired in	113
HVR2	Half wave, indirectly heated	4.0	0.65	4-pin	118



4 VALVE DATA PREFERRED TYPES F RECTIFIERS

AZ 31 Directly-heated full-wave rectifier

FILAMENT

V_f 4.0 V I_f 1.1 A

OPERATING CONDITIONS

V_a (rms) max.	2 × 500	2 × 400	2 × 300	V
I_a max.	60	75	100	mA
Maximum capacitance of reservoir capacitor	60	60	60	μ F
At V_a (rms) 300–0–300 V	Reservoir capacitance 16 μ F			
I_{out} (mA)	Limiting resistance (each anode)			
	100	200	400	800 Ω
			V_{out} (D.C.)	
45	340	320	296	263 V
60	325	302	276	237 V
75	310	288	256	210 V
100	280	261	225	166 V
At V_a (rms) 400–0–400 V				
30	484	472	457	430 V
45	464	451	433	397 V
60	450	434	412	364 V
75	435	420	393	332 V
At V_a (rms) 500–0–500 V				
30	630	612	595	560 V
45	605	588	562	525 V
60	589	570	542	497 V

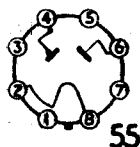

BASE:
Octal

DIMENSIONS:
L=111 mm
D=46 mm

CY 31

Indirectly-heated half-wave rectifier

HEATER

V_h 20 V I_h 0.2 A Suitable for series operation, D.C. or A.C.
Heating time 70 secs

OPERATING CONDITIONS

V_a (rms) max.	250 V
I_a max.	120 mA
V_{h-k} (pk) max.	350 V
Max. capacitance of reservoir capacitor (C)	Limiting resistance (R) in series with anode
(μ F)	(Ω)
8.0	0
16.0	75
32.0	125



CY 31
(contd.)

At V_a (rms) 150 V

I_{out} (mA)	C		V_{out} (D.C.)	32 μ F 125 Ω
	R			
40	8	16		
60	0	75		
80	163	157	153 V	
100	143	144	140 V	
120	125	132	130 V	
	110	123	120 V	
	92	115	111 V	

At V_a (rms) 200 V

40	226	227	221 V
60	204	210	204 V
80	185	190	196 V
100	165	180	175 V
120	148	167	163 V

At V_a (rms) 250 V

40	300	292	282 V
60	271	276	266 V
80	248	262	252 V
100	229	247	240 V
120	210	232	227 V

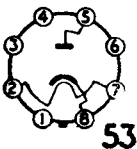

BASE:
Octal

DIMENSIONS:
L=112 mm
D=43 mm

Miniature indirectly-heated half-wave high voltage rectifier

EY 51

HEATER

V_h 6.3 V I_h 90 mA

Heater voltage tolerances

For I_{out} not exceeding 200 μ A	$\pm 15\%$
For $I_{out} = 500 \mu$ A	$\pm 7\%$

CAPACITANCE

C_{a-k}

0.8 μ F

OPERATING CONDITIONS

With sinusoidal input (up to 500 Kc/s)

P.I.V. max.	17 KV
I_{out} max.	0.5 mA
i_k (pk.) max.	4 mA
Min. limiting resistance	0.1 M Ω
*Max. reservoir capacitance	0.1 μ F

*For 50 c/s operation. At other frequencies capacitance to be inversely proportional to the frequency

OPERATING CONDITIONS

With pulse input

P.I.V. max.	17 KV
I_{out} max.	0.2 mA
* i_k (pk.) max.	80 mA
Max. filter capacitance	5,000 μ F

*For max. pulse duration of 5 μ secs.

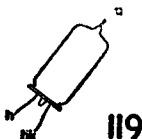

BASE:
B2A

DIMENSIONS:
L=53 mm plus wire leads
D=14.5 mm



4 VALVE DATA PREFERRED TYPES F RECTIFIERS

EY 91 Miniature indirectly-heated half-wave rectifier

HEATER

V_h 6.3 V I_h 0.42 A Heating time 20 secs approx.

OPERATING CONDITIONS

V_a (rms) (V)	Reservoir capacitance (C) (μ F)	Limiting resistance (R) (Ω)			
250	32	100			
	16	50			
	8	0			
200	32	70			
	16	30			
At V_a (rms) 150 V					
I_{out} (mA)	C	8	16	32	μ F
	R	0	0	25	Ω
			V_{out} (D.C.)		
45		155	170	172	V
60		140	160	166	V
75		122	152	160	V
At V_a (rms) 200 V					
I_{out} (mA)	C	8	16	32	μ F
	R	25	50	75	Ω
			V_{out} (D.C.)		
45		217	228	218	V
60		200	215	207	V
75		182	202	195	V
At V_a (rms) 250 V					
I_{out} (mA)	C	8	16	32	μ F
	R	50	100	125	Ω
			V_{out} (D.C.)		
45		276	282	280	V
60		259	270	268	V
75		241	255	250	V

LIMITING VALUES



54

V_a (rms) max.	250	V
I_a max.	75	mA
V_{h-k} (pk) max.	300	V
C max.	32	μ F

BASE :
B7G

DIMENSIONS :
L=54 mm
D=19 mm

Indirectly-heated full-wave rectifier

EZ 35

HEATER

V_h 6.3 V I_h 0.6 A

OPERATING CONDITIONS

V_a (rms) max.	2 × 325 V
I_a max.	70 mA
V_{h-k} (pk) (max.)	350 V
Max. capacitance of reservoir capacitor	16 μ F
Min. value of limiting resistance in series with each anode, when reservoir capacitance is 16 μ F	350 Ω

Reservoir capacitance = 4 μ F

I_{out} (mA)	2 × 150	2 × 200	2 × 250	2 × 300	2 × 350 V
			V_a (rms)		
			307	375	437 V
			V_{out} (D.C.)		
30	172	235	307	375	437 V
40	165	228	300	368	430 V
50	158	220	292	360	421 V
60	150	210	284	350	415 V
70	143	202	278	342	409 V

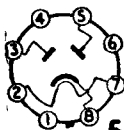

56

BASE :
Octal

DIMENSIONS :
L=93 mm
D=33 mm

Indirectly-heated full-wave rectifier

EZ 40

HEATER

V_h 6.3 V I_h 0.6 A

LIMITING VALUES

	2 × 250	2 × 275	2 × 300	2 × 350 V
V_a (rms)				90 mA
I_{out} max.	90	90	90	90 mA
Max. reservoir capacitance	50	50	50	50 μ F
Min. limiting resistance (each anode) (R)	125	175	215	300 Ω
V_{h-k} (pk) max.	500	500	500	500 V

OPERATING CONDITIONS

I_{out} (mA)	2 × 275 V (C = 50 μ F R = 175 Ω)	V_a (rms)	2 × 350 V (C = 50 μ F R = 300 Ω)
		V_{out} (D.C.)	
30	398		428 V
45	320		403 V
60	302		383 V
75	288		365 V
90	275		350 V



5

BASE :
B8A

DIMENSIONS :
L=80 mm
D=22 mm



4 VALVE DATA PREFERRED TYPES

F RECTIFIERS

EZ 41 Indirectly-heated full-wave rectifier

HEATER

V_h 6.3 V I_h 0.4 A

OPERATING CONDITIONS

V_a (rms) max.	2 × 250 V
V_{out} (approx.)	260 V
I_{out}	60 mA
Reservoir capacitance (C)	8 μ F
Limiting resistance (R)	150 Ω

LIMITING VALUES

V_a (rms) max.	2 × 250 V
I_{out} max.	60 mA
C max.	32 μ F
R min. (C = 8 μ F)	150 Ω
(C = 16 μ F)	250 Ω
(C = 32 μ F)	300 Ω
V_{h-k} (pk) max.	350 V

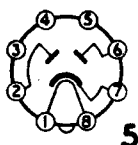

BASE :
B8A

DIMENSIONS :
L=60 mm
D=22 mm

FW 4-500 Directly-heated full-wave rectifier

FILAMENT

V_f 4.0 V I_f 3.0 A

OPERATING CONDITIONS

V_a (rms) V	Capacitance of reservoir capacitor (μ F)	Min. value of limiting resistances (Ω)
2 × 500	16	2 × 200
2 × 350	32	2 × 150

I_{out} (mA)	V_a (rms) 2 × 300	V_{out} (D.C.)	2 × 500 V
50	375	516	650
100	330	470	600 V
150	290	425	560 V
200	260	390	522 V
250	240	380	500 V

LIMITING VALUES

V_a (rms) max.	2 × 500 V
I_a max.	250 mA
P.I.V. max.	1,600 V

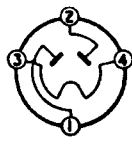

BASE :
British
4-pin

DIMENSIONS :
L=146 mm
D=51 mm

Indirectly-heated full-wave rectifier

GZ 32

HEATER

V_h 5.0 V I_h 2.3 A Heating time 25 secs. approx.

LIMITING VALUES

Capacitor input

V_a (rms) max.	2 × 300	2 × 350 V
I_{out} max.	300	250 mA

Reservoir capacitance (μ F)
60
32
16

Limiting resistance (Ω)
2 × 150
2 × 100
2 × 50

Choke input

V_a (rms) max.	2 × 400	2 × 500 V
I_{out} max.	300	250 mA

OPERATING CONDITIONS

Capacitor input

V_a (rms) V	C (μ F)	R (Ω)	V_{out} (D.C.) at					
			100	150	200	250	300 mA	
250-0-250	16	50	280	260	242	230	218	V
	32	100	270	248	230	212	200	V
	60	150	260	236	212	192	178	V
300-0-300	16	50	342	322	305	290	280*	V
	32	100	330	308	290	272	260*	V
	60	150	321	295	272	254	240*	V
350-0-350	16	50	410	388	372	360*	—	V
	32	100	392	370	352	340*	—	V
	60	150	389	360	339	320*	—	V

Choke input

300-0-300	242	232	226	215	210*	V
400-0-400	328	320	312	302	290*	V
500-0-500	416	408	398	390*	—	V

*Limiting values

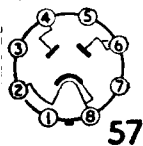

BASE :
Octal

DIMENSIONS :
L=120 mm
D=46 mm



4 VALVE DATA PREFERRED TYPES F RECTIFIERS

HVR 2 High-voltage half-wave rectifier

HEATER

V_h 4.0 V I_h 0.65 A Heating time 40 secs.

LIMITING VALUES

$V_{a(rms)}$ max.	6,000	V
I_a max.	3.0	mA
P.I.V. max.	20	KV

OPERATING CONDITIONS

Reservoir Capacitor=0.2 μ F
Smoothing Capacitor=0.1 μ F
Smoothing Resistor=0.4 M Ω

$V_{a(rms)}$ V	KV _{out} (D.C.) at					
	0.5	1.0	1.5	2.0	2.5	3.0
4,000 V	5.1	4.9	4.5	4.2	3.9	3.6
6,000 V	8.0	7.8	7.5	7.2	7.0	6.7

BASE : British 4-pin

DIMENSIONS :
L=131 mm
D=46 mm

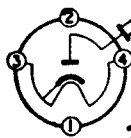

PY 31 Indirectly-heated half-wave rectifier

HEATER

V_h 17 V I_h 0.3 A Suitable for series operation, D.C. or A.C.

OPERATING CONDITIONS

$V_{a(rms)}$ V	Max. reservoir capacitance (C) (μ F)	Min. limiting resistance (R) (Ω)			
250	60	175			
	32	125			
	16	75			
	8	0			
170	60	100			
	32	75			
	16	30			
127	60	0			

With reservoir capacitance=32 μ F

$V_{a(rms)}$ V	V_{out} (D.C.) at			
110 (R=0)	50	75	100	125
220 (R=125 Ω)	120	110	100	90
	235	216	195	179

V_{in} (D.C.)	V_{out} (D.C.) at			
110 (R=0)	103	101	99	96
220 (R=125 Ω)	210	203	200	194

LIMITING VALUES

PY 31
 (contd.)

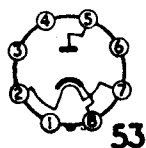

V_a max.	250 V
I_a max.	125 mA
V_{h-k} (pk) max.	300 V
P.I.V. max.	1,000 V
C max.	60 μ F

BASE : Octal
DIMENSIONS :
 L=112 mm
 D=44 mm

Indirectly-heated full-wave rectifier, primarily intended for use in series operated television equipment

PZ 30

HEATER

V_h 52 V I_h 0.3 A Suitable for series operation, D.C. or A.C.

INTERNAL RESISTANCE 100 Ω (per section)

OPERATING CONDITIONS

In half-wave circuit

V_a (rms) V	Reservoir capacitance (μ F)	Limiting resistance (each anode) (Ω)
240	50	50
240	32	30

With limiting resistors = $2 \times 50 \Omega$ and reservoir capacitor = 50 μ F

V_a (V_{rms})	V_{out} (D.C.) at						
	50	100	150	200	240	300	400 mA
240	306	280	272	250	250	225	205 V

OPERATING CONDITIONS

In voltage doubler circuit

V_a (rms)	220	240 V
I_{out}	200	200 mA
V_{out}	425	480 V
Limiting resistance (each anode)	30	30 Ω
Reservoir capacitance	2×32	$2 \times 32 \mu$ F

With limiting resistors = $2 \times 30 \Omega$ and reservoir capacitor = 32 μ F

V_a (rms) V	V_{out} (D.C.) at					
	60	80	100	150	200	mA
220	520	505	490	452	425	V
240	571	557	540	502	480	V

LIMITING VALUES

V_a (rms) max.	240 V
I_a max. (each anode)	200 mA
V_{h-k} (pk) max.	650 V
Max. reservoir capacitance	50 μ F

BASE : Octal
DIMENSIONS :
 L=120 mm
 D=46 mm



4 VALVE DATA PREFERRED TYPES F RECTIFIERS

UY 21 Indirectly-heated half-wave rectifier

HEATER

V_h 50 V I_h 0.1 A Suitable for series operation, D.C. or A.C.

OPERATING CONDITIONS

V_a (rms) (V)	Reservoir capacitance (μ F)	Limiting resistance (R) (Ω)				
250	60	175				
	32	125				
	16	75				
	8	0				
170	60	100				
	32	75				
	16	30				
127	60	0				
V_a V (rms)		V_{out} (D.C.) at				
	50	75	100	125	140	mA
110 (R=0)	116	108	100	95	88	V
127 (R=0)	140	130	122	115	110	V
220 (R=125 Ω)	232	211	195	180	169	V
V_a (D.C.)						
110 (R=0)	104	101	98	95	93	V
127 (R=0)	124	121	119	117	115	V
220 (R=125 Ω)	210	205	200	196	191	V

LIMITING VALUES

V_a (rms) max.	250 V
I_a max.	140 mA
V_{h-k} (pk) max.	550 V
C max.	60 μ F

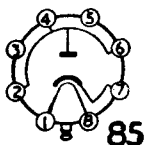

BASE :
B8G

DIMENSIONS :
L=93 mm
D=28 mm

Indirectly-heated half-wave rectifier

UY 41

HEATER

V_h 31 V I_h 0.1 A Suitable for series operation, D.C. or A.C.

OPERATING CONDITIONS

V_a max. (V_{rms})	Minimum value of series protective resistance (with 50 μ F capacitor) (R)				
	(Ω)				
220	160				
127	0				
117	0				
110	0				

$V_{a(rms)}$ V	V_{out} (D.C.) at				
	20	40	60	80	90 mA
110 (R=0)	130	120	111	105	102 V
117 (R=0)	140	128	120	114	111 V
127 (R=0)	153	142	134	127	125 V
220 (R=160 Ω)	260	234	211	196	191 V

V_a (D.C.)	V_a				
110 (R=0)	105	101	98	96	95 V
220 (R=160 Ω)	210	203	196	192	190 V

LIMITING VALUES

$V_{a(rms)}$ max.	250 V
I_a max.	90 mA
V_{a-k} (pk) max.	550 V
C max.	50 μ F

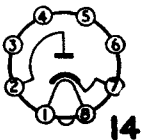

BASE :
B8A

DIMENSIONS :

L=64 mm
D=22 mm



ELECTRON BEAM INDICATORS

Type	Description	Principal Applications	Page
EM 34	Electron Beam Indicator	Visual Tuning Indicator in A.C. Mains Receivers	124
IM 34	Electron Beam Indicator	Visual Tuning Indicator in series operated Mains Receivers	124



4 VALVE DATA PREFERRED TYPES

G ELECTRON BEAM INDICATORS

EM 34 HEATER

V_h 6.3 V I_h 0.2 A Suitable for series operation, D.C. or A.C.

OPERATING CONDITIONS

V_b	200	250	V
R_{b^*}	1	1	M Ω
R_{b^*}	1	1	M Ω
I_t	0.55	0.75	mA
V_g (1)	0	0	V
V_g (2)	0	0	V
V_g (5)	-4.2	-5.0	V
V_g (6)	-12.5	-16.0	V

(1) and (2) Max. angle of the shadows produced by the deflector plates x' , x'' and y' , y'' respectively

(5) and (6) Min. angle (5°) of the shadows produced by the deflector plates x' , x'' and y' , y'' respectively

LIMITING VALUES

$V_{b^*(b)}$ max.	550	V
V_{b^*} max.	275	V
$V_{b^*(b)}$ max.	550	V
V_{b^*} max.	275	V
$V_{i(b)}$ max.	550	V
V_i max.	275	V
V_{h-k} max.	100	V
R_{g-k} max.	3	M Ω

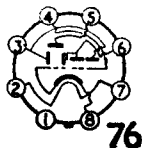

BASE :
Octal

DIMENSIONS :
L=90 mm
D=28 mm

UM 34 HEATER

V_h 12.6 V I_h 0.1 A Suitable for D.C./A.C. operation

With the exception of heater ratings the Type UM 34 is identical with Type EM 34 to which please refer

TRANSMITTING VALVES AND MERCURY VAPOUR RECTIFIERS

TRANSMITTING VALVES

Type	Description	Principal Applications	Page
DL93	Miniature R.F. pentode	Power amplifier in miniature communications equipment	126
EC52	Triode	Low power oscillator for frequencies up to 400 Mc/s ...	127
EC53	Miniature Triode ...	Low power oscillator for frequencies up to 600 Mc/s ...	127
EC91	Miniature Triode ...	Grounded grid amplifier for frequencies up to 250 Mc/s ...	128
EC91	Miniature Double Triode	R.F. push-pull amplifier or oscillator for frequencies up to 250 Mc/s	130
ME1001	Disc Seal Triode ...	Concentric line oscillator or power amplifier for frequencies up to 3,500 Mc/s ...	131
TY2-125	VHF Triode	R.F. Power amplifier, oscillator or modulator for frequencies up to 200 Mc/s	131
QV04-7	Beam Tetrode	R.F. amplifier or frequency multiplier for frequencies up to 150 Mc/s	133
QV05-25	Beam Tetrode	A.F. amplifier or modulator ; R.F. amplifier or oscillator for frequencies up to 75 Mc/s ...	135
QY2-100	Beam Tetrode	Class "C" R.F. amplifier for frequencies up to 60 Mc/s ...	138
QY3-125	R.F. Tetrode	Power amplifier for frequencies up to 100 Mc/s	140
QQV04-20	Twin Beam Tetrode ...	Push-pull Power amplifier for frequencies up to 200 Mc/s...	142
QQV06-40	Twin Beam Tetrode ...	Amplifier or oscillator for frequencies up to 300 Mc/s ...	145
QQV07-40	Twin Beam Tetrode ...	Amplifier or oscillator for frequencies up to 250 Mc/s ...	147
QZ04-15	Twin Tetrode	Amplifier, oscillator for frequencies up to 186 Mc/s ...	149

MERCURY VAPOUR RECTIFIER

Type	Page
RG1-240A	150
RG3-250	151



**H TRANSMITTING VALVES AND
MERCURY VAPOUR RECTIFIERS**

DL 93 Directly-heated for use in miniature communications equipment as an R.F. power amplifier

For appli-
cation as
output
pentode see
Section E,
page 88

FILAMENT ARRANGEMENT

Suitable for D.C. operation only

- (a) Series V_f applied across the two filament sections in series between pins 1 and 7. V_{g1} referred to pin 1.
- (b) Parallel V_f applied across the two filament sections in parallel between pin 5 and pins 1 and 7 connected together. V_{g1} referred to pin 5.

Series 1.4 V 0.2 A Parallel 2.8 V 0.1 A

CAPACITANCES

Measured without external screen

C_{a-g1}	<0.34	$\mu\mu\text{F}$
C_{1a}	4.8	$\mu\mu\text{F}$
C_{out}	4.2	$\mu\mu\text{F}$

OPERATING CONDITIONS

As R.F. power amplifier at 50 Mc/s (Intermittent operation)

Filament arrangement : Parallel*

V_a	150	V
V_{g2}	135	V
R_{g1}	0.2	M Ω
I_a (max. sig.)	18.3	mA
I_{g2} (max. sig.)	6.5	mA
I_{g1} (max. sig.)	0.13	mA
P_{out} approx.	1.2	W

*Operation with series connected filament will be similar to that with parallel connection. With series connection a shunting resistor must be connected between pins 1 and 5 to by-pass the cathode current.

LIMITING VALUES

R.F. power amplifier (intermittent operation)

V_a max.	150	V
V_{g2} max.	135	V
V_{g1} max.	-30	V
I_a max.	20	mA
I_{g1} max.	0.25	mA
I_k max.	25	mA
p_a max.	2	W



BASE :
B7G

DIMENSIONS :
L=54 mm
D=19 mm



**TRANSMITTING VALVES AND
MERCURY VAPOUR RECTIFIERS**

Single-ended short-wave triode for use as low power oscillator

EC 52

HEATER

V_h 6.3 V I_h 0.43 A

CAPACITANCES

C_{g-k}	5.2	$\mu\mu\text{F}$
C_{a-k}	1.3	$\mu\mu\text{F}$
C_{a-g1}	3.1	$\mu\mu\text{F}$

CHARACTERISTICS

V_a	250	V
V_{g1}	-2.6	V
I_a	10	mA
g_m	6.5	mA/V
μ	60	
r_a	9.2	K Ω
R_{oq}	310	Ω

LIMITING VALUES

V_a max.	400	V
P_a max.	7.5	W
Limiting frequency of oscillation	400	Mc/s

Note.—At frequencies up to 300 Mc/s the inductance of the heater leads is sufficiently low to allow the heater pins to be earthed capacitatively



89

BASE :
B9G

DIMENSIONS :
L=78 mm
D=38 mm

Miniature triode for use as low power oscillator at frequencies up to 600 Mc/s

EC 53

HEATER

V_h 6.3 V I_h 0.25 A

For circuits
see page 129

CAPACITANCES

C_{g-k}	1.3	$\mu\mu\text{F}$
C_{a-k}	0.13	$\mu\mu\text{F}$
C_{a-g}	1.3	$\mu\mu\text{F}$

CHARACTERISTICS

V_a	200	V
V_g	-3.3	V
I_a	7.5	mA
g_m	2.9	mA/V
μ	33	
r_a	11.4	K Ω
g_m ($V_g=0$)	4.0	mA/V



4 VALVE DATA PREFERRED TYPES

H TRANSMITTING VALVES AND MERCURY VAPOUR RECTIFIERS

EC 53 (contd.)

OPERATING CONDITIONS

As power oscillator up to 400 Mc/s

f (Mc/s)	V _a (V)	I _a (mA)	I _g (mA)	P _{out} W	η %	Refer to circuit
110	250	14.5	5	1.3	35	} see Fig. 1
165	250	14.5	5	1.2	33	
210	250	12.5	3.6	0.8	26	
285	250	12.5	3.6	0.5	16	
335	200	12.5	3.6	0.35	14	} see Fig. 2
400	200	12.5	3.6	0.3	12	

Note.—The input power is reduced at the higher frequencies in order to keep within the rated maximum anode dissipation

LIMITING VALUES

V _a max.	250	V
p _a max.	2.5	W
I _k max.	20	mA
R _{g-k} max.	0.5	MΩ
V _{h-k} max.	40	V
Max. operating frequency	600	Mc/s



BASE :
B3G

DIMENSIONS :
L=54 mm
D=16 mm

EC 91 Miniature grounded-grid triode

HEATER

V_h 6.3 V I_h 0.3 A

CAPACITANCES

(with external shield connected to grid)

C _{a-g}	3.8	μμF
C _{a-k+h}	<0.2	μμF
C _{g-k+h}	5.25	μμF

OPERATING CONDITIONS

V _a	250	V
V _g	-1.5	V
R _k	150	Ω
I _a	10	mA
g _m	8.5	mA/V
μ	100	
r _a	12	KΩ
R _{eq}	400	Ω

LIMITING VALUES

V _a max.	250	V
p _a max.	2.5	W
I _k max.	15	mA
V _{h-k} max.	150	V
V _{g-k} max.	100	V
Max. operating frequency	250	Mc/s

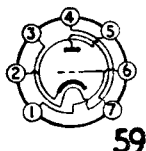

BASE :
B7G

DIMENSIONS :
L=54 mm
D=19 mm

**TRANSMITTING VALVES AND
MERCURY VAPOUR RECTIFIERS **H****

COIL DATA

LENGTH 1"
DIAMETER $\frac{1}{2}$ "
4 TURNS FOR 110-165 Mc/s.
3 TURNS FOR 165-210 Mc/s.

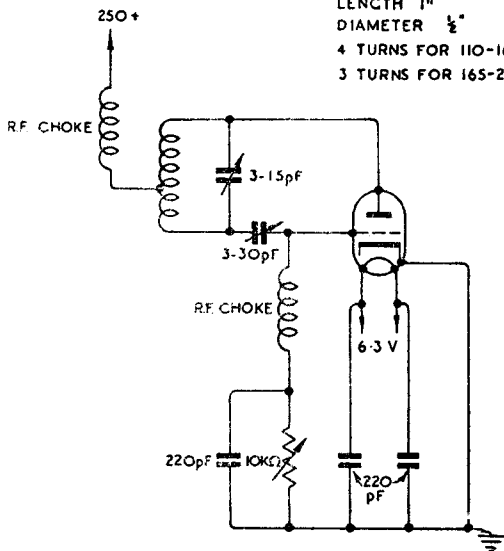

Fig. 1.

*EC 53 as Low Power
Oscillator at Frequencies
between 110 and 210 Mc/s*

LINE DATA

LINE SEPARATION, $d = 2.8$ cm
280-350 Mc/s. $l = 10$ cm. approx.
400-500 Mc/s. $l = 5$ cm. approx.
600 Mc/s. $l = 2$ cm. approx.

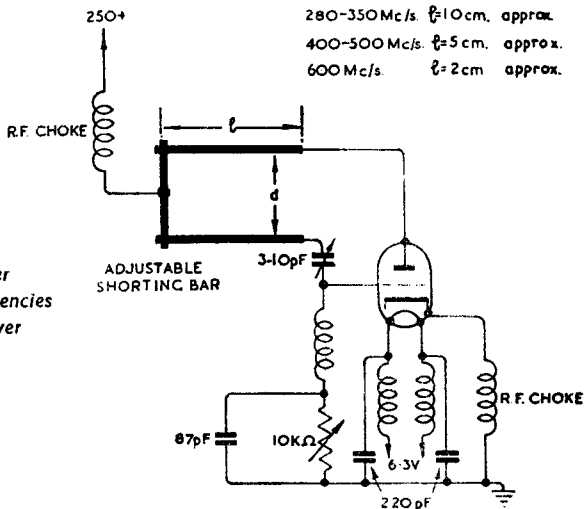

Fig. 2.

*EC 53 as Low Power
Oscillator at Frequencies
of 280 Mc/s and over*

**H TRANSMITTING VALVES AND
MERCURY VAPOUR RECTIFIERS**

ECC 91

Double triode with common cathode for use as R.F. power amplifier or oscillator

For application as voltage amplifier see Section D, page 75

HEATER

V_h 6.3 V I_h 0.45 A

MOUNTING POSITION

Vertical : base up or down

CAPACITANCES

Each section

C_{a-g}	1.6	$\mu\mu\text{F}$
C_{g-k}	2.2	$\mu\mu\text{F}$
C_{a-k}	0.4	$\mu\mu\text{F}$

CHARACTERISTICS

Each section

V_a	100	V
I_a	8.5	mA
V_g	-0.9	V
g_m	5.3	mA/V
μ	38	
r_a	7.1	K Ω

OPERATING CONDITIONS

As Class "C" telegraphy push-pull R.F. amplifier and oscillator at 80 Mc/s approx.

V_a	150	V
* V_g	-10	V
R_g	625	Ω
R_k	220	Ω
I_a	2×15	mA
I_g	2×8	mA
P_{drive}	0.35	W
P_{out}	3.5	W

*Obtained from a fixed supply or from a grid or cathode resistor of value shown

Note.—An output of 1 watt may be obtained from an ECC 91 in a push-pull oscillator at 250 Mc/s with $V_a=150$ V, $p_a=2 \times 1.5$ W and a common grid resistor of 2,000 Ω

LIMITING VALUES

V_a max.	300	V
p_a max.	2×1.5	W
V_g max.	-40	V
I_g max.	2×8	mA
V_{b-k} max.	100	V
R_{g-k} max. (self bias)	0.5	M Ω

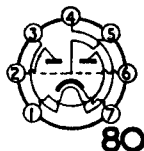

80

BASE :
B7G

DIMENSIONS :
L=54 mm
D=19 mm



**TRANSMITTING VALVES AND
MERCURY VAPOUR RECTIFIERS**

ME 1001

Indirectly-heated disc seal triode (without internal feedback) intended mainly as a common grid, earthed anode, concentric line oscillator. It may also be used as a power amplifier.

When used in a co-axial line circuit with an anode input of 10 watts, the output power is approximately 0.5 watts at 10 cms, rising to 3 watts at 30 cms.

The lower limit of operating wavelength is 8-8.5 cms.

HEATER

V_h 6.3 V I_h 0.4 A approx.

OUNTING POSITION

Any

CAPACITANCES

C_{a-g}	1.1	$\mu\mu F$
C_{a-k}	0.02	$\mu\mu F$
C_{g-k}	2.2	$\mu\mu F$

CHARACTERISTICS

V_a	250	V
V_g	-3.5	V
I_a	20	mA
g_m	6.0	mA/V
μ	30	approx.

LIMITING VALUES

V_a max.	350	V
p_a max.	10	W
I_a max.	50	mA
I_a (pk) max.	150	mA
*Anode seal temp. max.	140	°C

*In order to limit the anode seal temperature and also to limit the rate of change of anode seal temperature, it is necessary that the mass of metal in close thermal contact with the anode disc be not less than 60 grams (2 ozs) of brass or its equivalent



DIMENSIONS :

L=63 mm
D=23 mm

V.H.F. triode with hard glass envelope and strong double helical thoriated tungsten filament, designed for use as an R.F. amplifier, oscillator, grounded-grid amplifier or modulator.

At maximum ratings the maximum operating frequency is 150 Mc/s.

TY2-125

*Preliminary
Data*

FILAMENT

V_f (D.C. or A.C.)	6.3	V
I_f (approx.)	5.4	A



4 VALVE DATA PREFERRED TYPES

H TRANSMITTING VALVES AND MERCURY VAPOUR RECTIFIERS

TY2-125 MOUNTING POSITION

(contd.) Vertical only, base up or down

CAPACITANCES

C_{a-g}	5.8 $\mu\mu\text{F}$ approx.
C_{g-f}	6.0 $\mu\mu\text{F}$ approx.
C_{a-f}	0.2 $\mu\mu\text{F}$ approx.

CHARACTERISTICS. measured at $V_a=2.5 \text{ KV}$, $I_a=50 \text{ mA}$

$g_{m\mu}$	3.0	mA/V
μ	26	

LIMITING VALUES

V_a max.	2,500	V
* p_a max.	135	W
I_k max.	240	mA
Max. operating frequency at full ratings	150	Mc/s
Max. operating frequency at 80% V_a max. and 87% I_k max.	200	Mc/s
Max. temperature of bottom of bulb	180	$^{\circ}\text{C}$
Max. temperature of anode lead out	225	$^{\circ}\text{C}$

*Anode red hot (temperature 850°C .)

COOLING

When the valve is operated at near maximum ratings it is possible that the maximum temperature limits may be exceeded, in which case an air flow of up to $\frac{1}{2}$ cu. ft. (10 litres) per minute must be directed towards the centre of the valve base.

An anode terminal connector having a large area is necessary in order to keep the anode seal cool.

OPERATING CONDITIONS FOR TWO VALVES IN PUSH-PULL AS CLASS "B" L.F. AMPLIFIERS OR MODULATORS

V_a	1,500	2,000	2,500	V
V_g (approx.)	-53	-68	-90	V
$I_{a(o)}$	2×42	2×50	2×40	mA
I_a (max. sig.)	2×166	2×169	2×165	mA
I_g	2×57	2×50	2×40	mA
$V_{in(pk)}$ (approx.)	2×138	2×153	2×175	V
R_{a-a}	11	13	16	K Ω
P_{out}	340	460	560	W
D_{tot} (approx.)	3	3.5	4	%
η	68	68	68	%



**TRANSMITTING VALVES AND
MERCURY VAPOUR RECTIFIERS** **H**

OPERATING CONDITIONS AS SINGLE VALVE R.F. POWER OSCILLATOR OR AMPLIFIER **TY2-125**
(contd.)

	(Class "C" Telegraphy)					
f	<150	<150	<150	<150	200	Mc/s
V _a	1,000	1,500	2,000	2,500	2,000	V
V _g	-80	-120	-150	-200	-150	V
I _a	200	200	200	200	170	mA
I _g	40	40	40	40	40	mA
V _{in} (pk)	230	270	300	350	325	V
P _{drive}	9.2	10.8	12	14	13	W
P _{out}	100	200	280	360	180	W
η	50	67	70	72	53	%

OPERATING CONDITIONS AS R.F. POWER AMPLIFIER (Class "C" Anode Modulated)

f	60	60	60	Mc/s
V _a	1,000	1,500	2,000	V
V _g (approx.)	-120	-150	-200	V
I _a	130	130	130	mA
I _g (approx.)	50	50	50	mA
V _{in} (pk) (approx.)	280	310	360	V
P _{drive} (approx.)	14	15.5	18	W
P _{out}	65	130	180	W
η	50	67	70	%
*P _{mod}	65	97.5	130	W

* For 100% modulation

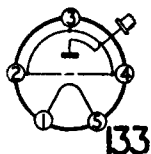

BASE :
MVH 18

DIMENSIONS :
L=129 mm
D=62mm

Indirectly-heated beam tetrode with aligned grid construction to minimise screen current. It is rated to dissipate a maximum of 7.5 watts at the anode and is particularly suitable for use at frequencies up to 150 Mc/s as an R.F. amplifier or as a frequency multiplier.

QVO47

EATER

V_b 6.3 V I_b 0.6 A Suitable for D.C. or A.C. operation
Heating time 22 secs.

MOUNTING POSITION Any

CAPACITANCES

C _{in}	8.0	μμF
C _{out}	5.4	μμF
C _{a-g1}	<0.1	μμF

CHARACTERISTICS

At V_a=300 V V_{g2}=250 V I_a=25 mA

g _m	1.9	mA/V
μ _{g1-g2}	5.6	
r _a	67	K Ω



4 VALVE DATA PREFERRED TYPES

H TRANSMITTING VALVES AND MERCURY VAPOUR RECTIFIERS

QVO47 LIMITING VALUES

(contd.)

V_a max.	400	V
V_{g2} max.	250	V
p_a max.	7.5	W
p_{g2} max.	2.0	W
I_k max.	50	mA
I_{g1} max.	6.0	mA

OPERATING CONDITIONS

As single valve Class "C", R.F. amplifier

Frequency	3	3	20	20	Mc/s
V_a	300	300	300	300	V
V_{g2}	150	250	150	250	V
V_{g1}	-35	-50	-30	-60	V
I_a	40	43	43.5	43.7	mA
I_{g2}	7.2	6.6	4.7	5.9	mA
I_{g1}	2.8	0.4	1.8	0.4	mA
$V_{in(pk)}$	58	60	48	67	V
P_{out}	7.1	8.1	7.3	7.9	W
p_a	4.9	4.8	5.8	5.2	W
η	59	62	56	60	%

Frequency	60	60	150	150	Mc/s
V_a	300	300	300	300	V
V_{g2}	150	250	150	250	V
V_{g1}	-30	-50	-30	-50	V
I_a	44	44	44	46	mA
I_{g2}	4.5	6.0	4.5	4.0	mA
I_{g1}	1.9	0.4	1.5	0.4	mA
$V_{in(pk)}$	48	57	52	57	V
P_{out}	7.0	7.7	6.3	6.3	W
η	53	58	47	45	%

As push-pull Class "C", R.F. amplifier

Frequency	60	100	150	Mc/s
V_a	300	300	300	V
V_{g2}	250	250	250	V
V_{g1}	-60	-60	-50	V
I_a	2×43.0	2×44.4	2×46	mA
I_{g2}	2×6.7	2×5.3	2×4.0	mA
I_{g1}	2×0.5	2×0.4	2×0.4	mA
$V_{in(pk)}$	2×68	2×68	2×57	V
P_{out}	15.6	14.7	12.6	W
p_a	2×5.1	2×6.0	2×7.4	W
η	60	55	46	%

As frequency doubler, Single valve

Output frequency	20	75	100	150	Mc/s
V_a	300	300	300	250	V
V_{g2}	250	250	200	200	V
V_{g1}	-80	-120	-120	-120	V
I_a	41.2	43.3	38.4	36.8	mA
I_{g2}	8.0	5.5	2.6	2.1	mA
I_{g1}	0.8	1.2	1.5	1.1	mA
$V_{in(pk)}$	81	124	120	144	V
P_{out}	5.6	5.6	4.4	2.3	W
p_a	6.8	7.4	7.1	6.9	W
η	45	44	38	25	%



**TRANSMITTING VALVES AND
MERCURY VAPOUR RECTIFIERS**

OPERATING CONDITIONS (contd.)

QVO47
(contd.)

As frequency trebler.	Single valve			Push-pull	
Output frequency	20	75	100	150	Mc/s
V_a	300	300	275	225	V
V_{g2}	250	250	200	200	V
V_{g1}	-120	-140	-140	-140	V
I_a	35.2	34.1	36.0	2×36	mA
I_{g2}	4.2	2.8	2.5	2×2.5	mA
I_{g1}	0.6	0.6	1.5	2×1.3	mA
$V_{in(pk)}$	109	130	142	2×152	V
P_{out}	3.3	3.2	2.8	3.1	W
P_a	7.3	7.1	7.1	2×6.6	W
η	31	31	28	19	%

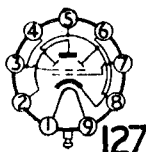

BASE :
B9G

DIMENSIONS :
L=78 mm
D=38 mm

Indirectly-heated beam tetrode rated for a maximum anode dissipation of 25 watts. It is suitable for use as an A.F. amplifier or modulator or as an R.F. amplifier or oscillator. **QVO5-25**

HEATER

V_h 6.3 V I_h 0.9 A

Heating time 15 secs.

MOUNTING POSITION

Any

CAPACITANCES (measured with external shield)

C_{1a}	11	$\mu\mu\text{F}$
C_{out}	7	$\mu\mu\text{F}$
C_{a-g1}	<0.2	$\mu\mu\text{F}$

CHARACTERISTICS

At $V_a=600$ V $V_{g2}=300$ V $I_a=72$ mA

μ_{g1-g2}	8	
g_m	6.0	mA/V



**H TRANSMITTING VALVES AND
MERCURY VAPOUR RECTIFIERS**

QV05-25 LIMITING VALUES

(contd.)

V_a max.	600	V
V_a (pk) max.	2,000	V
P_a max.	25	W
V_{g2} max.	300	V
P_{g2} max.	3.5	W
V_{g1} max.	-200	V
I_k max.	150	mA
I_k (pk) max.	400	mA
I_{g2} max.	10	mA
I_{g1} max.	5	mA
I_{g1} (pk) max.	25	mA
V_{h-k} max.	100	V
R_{g1-k} max.	25	K Ω

Operating frequency (Mc/s)	Max. anode voltage (V)	Max. anode input power (W)
60	600	60
75	500	50

OPERATING CONDITIONS

For push-pull pair as Class "AB₂" A.F. power amplifier and modulator

V_a	400	500	600	V
V_{g2}	300	300	300	V
V_{g1}	-25	-25	-30	V
$I_{a(o)}$	2 × 50	2 × 50	2 × 30	mA
$I_{g2(o)}$	2 × 2.5	2 × 2.5	2 × 2.5	mA
V_{in} (pk)	2 × 39	2 × 39	2 × 39	V
I_a (max. sig.)	2 × 120	2 × 120	2 × 100	mA
I_{g2} (max. sig.)	2 × 5	2 × 5	2 × 5	mA
R_{a-a}	3.2	4.24	6.4	K Ω
P_{drive} (max. sig.)*	0.2	0.2	0.1	W approx.
P_{out}	55	75	80	W approx.

*The effective resistance of the grid circuit should be below 500 Ω and the effective impedance should not exceed 700 Ω at the highest response frequency required.

For single valve as R.F. amplifier, Class "B" telephony

V_a	400	500	600	V
V_{g2}	250	250	250	V
V_{g1}	-25	-25	-25	V
I_a	75	75	62.5	mA
I_{g2}	4	4	3	mA
V_{in} (pk)	30	30	20	V
P_{drive} (approx.)	0.25	0.25	0.2	W
P_{out} (approx.)	9.0	12.5	12.5	W

TRANSMITTING VALVES AND
MERCURY VAPOUR RECTIFIERS

OPERATING CONDITIONS (contd.)

QV05-25
(contd.)

For single valve as R.F. amplifier, Class " C " telephony, anode modulated

V_a	325	400	475	V
* V_{g2}	225	225	225	V
R_{g2}	20	30	50	K Ω
** V_{g1}	-75	-80	-85	V
R_{g1}	25	22.8	21.3	K Ω
I_a	80	80	83	mA
I_{g2}	5	5.75	5	mA
I_{g1}	3	3.5	4	mA approx.
V_{in} (pk)	90	95	110	V
P_{drive}	0.25	0.3	0.4	W approx.
P_{out}	17.5	22.5	27.5	W approx.

*Preferably obtained from modulated anode supply through resistor R_{g2} of value shown.

**May be obtained either from fixed supply or by a grid resistor of value shown, or by a combination of fixed supply and grid resistor.

For single valve as R.F. amplifier and oscillator, Class " C " telegraphy

V_a	400	500	600	V
* V_{g2}	250	250	250	V
R_{g2}	20	42	50	K Ω
** V_{g1}	-45	-45	-45	V
R_{g1}	12.8	12.8	12.8	K Ω
R_k	410	410	410	Ω
I_a	100	100	100	mA
I_{g2}	7.5	6.0	7.0	mA
I_{g1}	3.5	3.5	3.5	mA approx.
V_{in} (pk)	65	65	65	V
P_{drive}	0.2	0.2	0.2	W approx.
P_{out}	25	30	40	W approx.

*Obtained from a fixed supply or from a potentiometer, or from the anode supply through resistor of value shown.

**May be obtained from a fixed supply or from a grid or cathode resistor of value shown, or by a combination of these methods.



BASE :
American
Medium 5-Pin

DIMENSIONS :
L = 147 mm
D = 53 mm



4 VALVE DATA PREFERRED TYPES

H TRANSMITTING VALVES AND MERCURY VAPOUR RECTIFIERS

QY2-100 Beam power tetrode with a maximum anode dissipation of 100 watts, primarily intended for use as a Class "C" R.F. amplifier at frequencies up to 60 Mc/s

FILAMENT

Thoriated tungsten

V_f 10.0 V I_f 5.0 A

MOUNTING POSITION

Vertical

CAPACITANCES

C_{in}	16.3	$\mu\mu F$
C_{out}	14.0	$\mu\mu F$
C_{a-g1}	< 0.25	$\mu\mu F$

CHARACTERISTICS

At $V_a=2,000$ V $V_{g2}=400$ V $I_a=50$ mA

g_m	3.75	mA/V
r_a	45	K Ω
μ_{g1-g2}	8.5	

LIMITING VALUES

V_a max.	2,000	V
$V_{a(pk)}$ max.	7,000	V
V_{g2}	400	V
$V_{g2(b)}$ max.	800	V
V_{g1} max.	-300	V
I_k max.	2.25	mA
$i_{k(pk)}$ max.	800	mA
I_{g2} max.	55	mA
I_{g1} max.	25	mA
$i_{g1(pk)}$ max.	75	mA
P_a max.	100	W
P_{g2} max.	15	W

Operating Frequency (Mc/s)	Max. Anode Voltage (V)	Max. Anode Input Power (V)
30	2,000	375
60	1,000	175

OPERATING CONDITIONS

As single R.F. power amplifier, Class "B" telephony

V_a	1,500	2,000	V
V_{g2}	400	400	V
V_{g1}	-60	-75	V
I_a	100	75	mA
I_{g2}	4	3	mA
$V_{drive(pk)}$	70	80	V
P_{drive}	< 2	< 2	W
P_{out}	50	50	W



TRANSMITTING VALVES AND MERCURY VAPOUR RECTIFIERS

OPERATING CONDITIONS (contd.)

QY2-100
(contd.)

As single R.F. power amplifier (Class "C" unmodulated)
or as oscillator

V_a	1,250	1,500	2,000	V
* V_{g2}	300	300	400	V
R_{g2}	27	40	36	K Ω
** V_{g1}	-75	-90	-120	V
R_{g1}	6	7.5	12	K Ω
R_k	330	400	520	Ω
I_a	180	180	180	mA
I_{g2}	35	30	45	mA
I_{g1}	12	12	10	mA
$V_{drive(pk)}$	160	175	205	V
P_{drive}	1.7	1.9	1.9	W
P_{out}	170	210	275	W

*May be obtained from a fixed supply or from the anode supply through a series resistor of value shown. In the latter case provision must be made to ensure the $V_{g2(b)}$ does not exceed 800 V.

**May be obtained either from a fixed supply or by a grid or cathode resistor of value shown, or by a combination of these methods.

As single R.F. power amplifier, Class "C", grid modulated

V_a	1,500	2,000	V
V_{g2}	400	400	V
V_{g1}	-140	-120	V
I_a	70	75	mA
I_{g2}	3	3	mA
$V_{drive(pk)}$ R.F.	145	120	V
$V_{drive(pk)}$ A.F.	60	60	V
P_{drive} R.F.	<2	<2	W
P_{mod}	<1	<1	W
P_{out}	40	50	W

As single R.F. power amplifier, Class "C", anode and screen modulated

V_a	1,250	1,600	V
* V_{g2}	300	300	V
R_{g2}	27	43	K Ω
** V_{g1}	-160	-160	V
R_{g1}	12.5	13.5	K Ω
I_a	150	150	mA
I_{g2}	35	30	mA
I_{g1}	13	12	mA approx.
$V_{drive(pk)}$ R.F.	250	250	V
P_{drive}	2.9	2.7	W approx.
P_{out}	140	180	W approx.

*May be obtained from a separate supply modulated simultaneously with the anode supply, or from a modulated anode supply through a series resistor of value shown.

**May be obtained from a fixed supply or by grid resistor of value shown.

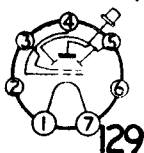

BASE :
MVH15
Giant 7-Pin

DIMENSIONS :
L=192 mm
D=66 mm



**H TRANSMITTING VALVES AND
MERCURY VAPOUR RECTIFIERS**

QY3-125 All-glass tetrode rated for a maximum anode dissipation of 125W and suitable for use at frequencies up to 120 Mc/s at full ratings, and up to 200 Mc/s at reduced ratings.

FILAMENT

Thoriated tungsten, suitable for D.C. or A.C. operation

V_f 5.0 V

I_f 6.5 A

MOUNTING POSITION

Vertical, base up or down

CAPACITANCES

C_{in} 11.2 $\mu\mu F$

C_{out} 4.2 $\mu\mu F$

C_{a-g1} 0.05 $\mu\mu F$

CHARACTERISTICS

At $V_a=2,500V$, $V_{g2}=350V$, $I_a=40mA$.

g_m 2.2 mA/V

μ_{g1-g2} 6

LIMITING VALUES

V_a max. 3,000 V

V_{g2} max. 600 V

P_a max. (corresponding to an anode temperature of 850°C, i.e. red heat) 125 W

P_{g2} max. 25 W

I_k max. 270 mA

I_k (pk) max. 1.1 A

Max. temperature of anode seal 220 °C

Max. temperature of base pins 180 °C

COOLING

In order to keep within the temperature limits it may be necessary to direct a flow of air on to the anode seal and the base of the valve at frequencies above 50 Mc/s. The air stream on to the base should be directed so that it also passes over the envelope. Below 50 Mc/s, radiation cooling from the envelope is sufficient but an anode terminal connection of large surface area, is necessary in order to keep the anode seal cool.

**OPERATING CONDITIONS AS SINGLE VALVE
R.F. POWER AMPLIFIER (Class "C" Unmodulated)
at 120 Mc/s.**

V_a	2,000	2,500	3,000	V
V_{g2}	350	350	350	V
V_{g1}	-100	-150	-150	V
I_a	200	200	167	mA
I_{g2}	50	40	30	mA
I_{g1}	9	9	6.5	mA
V_{in} (pk)	260	330	300	V
P_{g1}	2.4	3	2	W
P_a	125	125	125	W
P_{g2}	17.5	14	10.5	W
P_{out}	275	375	375	W
η	69	75	75	%



TRANSMITTING VALVES AND MERCURY VAPOUR RECTIFIERS

**OPERATING CONDITIONS FOR SINGLE VALVE
AS R.F. AMPLIFIER CLASS "C" TELEPHONY
(Anode and Screen Modulated) at 120 Mc/s.**

QY3-125
(contd.)

V_a	2,000	2,500	V
V_{g2}	350	350	V
V_{g1}	-220	-210	V
I_a	150	152	mA
I_{g2}	33	30	mA
I_{g1}	5	4.5	mA
P_{g1}	2	1.7	W
$V_{in} (pk)$	390	380	V
P_a	75	80	W
P_{g2}	11.5	10.5	W
P_{out}	225	300	W
η	75	79	%
Modulation Depth	100	100	%
P mod.	150	190	W
$V_{g2} (pk) mod.$	300	300	V

**OPERATING CONDITIONS FOR SINGLE VALVE
AS R.F. AMPLIFIER CLASS "B" TELEPHONY
At 120 Mc/s.**

V_a	2,000	2,500	3,000	V
V_{g2}	350	350	350	V
V_{g1}	-50	-50	-50	V
I_a	83	70	60	mA
I_{g2}	1.5	1	1	mA
$V_{in} (pk)$	65	55	50	V
P_a	112	120	122	W
P_{g2}	0.52	0.35	0.35	W
P_{out}	54	55	58	W
η	32.5	31.5	32	%
Modulation depth	100	100	100	%
I_{g1}	4	4	4.5	mA
P_{g1}	0.52	0.44	0.45	W

**OPERATING CONDITIONS FOR TWO VALVES IN
PUSH-PULL AS L.F. POWER AMPLIFIER OR
CLASS "B" MODULATOR**

(Without I_{g1})

V_a	1,500	2,000	2,500	V
V_{g2}	600	600	600	V
V_{g1}	-90	-94	-96	V
$I_{a(0)}$	2×30	2×30	2×30	mA
I_a max. sig.	2×111	2×120	2×116	mA
I_{g2} max. sig.	2×10	2×6	2×8	mA
I_{g1}	0	0	0	mA
$V_{in} (pk)$	2×90	2×94	2×96	V
P_a	2×88	2×125	2×125	W
P_{g2}	2×6	2×3.6	2×4.8	W
P_{out}	158	230	330	W
R_{a-a}	10,000	13,500	20,000	Ω
η	48	48	57	%



4 VALVE DATA PREFERRED TYPES

H TRANSMITTING VALVES AND MERCURY VAPOUR RECTIFIERS

QY3-125 OPERATING CONDITIONS FOR TWO VALVES IN PUSH-PULL AS L.F. POWER AMPLIFIER OR (contd.) CLASS "B" MODULATOR.

(With I_{g1})

V_a	1,500	2,000	2,500	V
V_{g2}	350	350	350	V
V_{g1}	-41	-45	-43	V
I_a (0)	2×45	2×40	2×50	mA
I_a max. sig.	2×200	2×150	2×130	mA
I_{g2} max. sig.	2×19	2×10	2×8	mA
I_{g1}	2×18	2×15	2×12	mA
V_{in} (pk)	2×145	2×110	2×95	V
P_{g1}	2×2.6	2×1.6	2×1.2	W
P_{g2}	2×6.7	2×3.5	2×2.8	W
P_{out}	350	350	400	W
R_{a-a}	7,000	13,500	22,000	Ω
η	58	58	61	%

CIRCUIT NOTES.

1. The R.F. circuit returns must be brought to the filament connection on Pin No. 1.
2. To ensure equal distribution of the currents through the seals the g_2 leads should be strapped together at the valve holder, and the circuit connections joined to the midpoint of the strap. This should not be allowed to impair the free flotation of individual contacts.

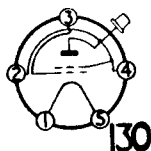

BASE :
MVH18

DIMENSIONS :
L=130 mm
D=62 mm

QQV 04-20

Twin beam tetrode with a maximum rated dissipation of 10 watts at each anode. It is primarily intended for use as a push-pull R.F. power amplifier or oscillator at frequencies up to 200 Mc/s. Arrangements should be made to earth the metal base of the valve by means of spring clips or by some alternative method. The cathode is indirectly heated with centre tapped heater for series or parallel connection.

HEATER

	Series	Parallel	
V_h	12.6	6.3	V
I_h	0.8	1.6	A

Heating time 20 secs.

MOUNTING POSITION

Vertical—base down Horizontal—plane of anodes vertical



**TRANSMITTING VALVES AND
MERCURY VAPOUR RECTIFIERS** **H**

QQV
04-20
(contd.)

CAPACITANCES

Each section

C_{in}	14	$\mu\mu F$
C_{out}	8.5	$\mu\mu F$
C_{a-g1}	<0.2	$\mu\mu F$

Between sections

C_{a-a}	0.8	$\mu\mu F$
-----------	-----	------------

CHARACTERISTICS

At $V_a=400$ V $V_{g2}=200$ V $I_a=25$ mA

g_m	4	mA/V
μ_{g1-g2}	6.5	

LIMITING VALUES

V_a max.	400	V
V_a (pk) max.	1,400	V
V_{g2} max.	225	V
$V_{g2(b)}$ max.	600	V
V_{g1} max.	-175	V
I_k max.	2×100	mA
* i_k (pk) max.	350	mA
I_{g2} max.	2×18	mA
I_{g1} max.	2×7	mA
* i_{g1} (pk) max.	20	mA
P_a max.	2×10	W
P_{g2} max.	2×2.25	W
V_{h-k} max.	100	V
* R_{g1-k} max.	30	K Ω

*Per section

Operating frequency (Mc/s)	Max. anode voltage (V)	Max. anode input power (W)
125	400	60
175	280	42
200	240	36

OPERATING CONDITIONS

As push-pull Class "C" R.F. power amplifier and oscillator

V_a	400	V
* V_{g2}	145	V
R_{g2}	15	K Ω
** V_{g1}	-45	V
R_{g1}	10	K Ω
R_k	260	Ω
I_a	2×75	mA
I_{g2}	2×8.5	mA
I_{g1}	2×2.25	mA
V_{in} (pk)	2×58	V
P_{drive}	0.23	W
P_{out}	44	W

*May be obtained from a separate supply or from the anode supply through series resistor of value shown, in which case provision must be made to ensure that $V_{g2(b)}$ does not exceed 600 V.

**May be obtained from a separate supply or by a grid or cathode resistor of value shown, or by a combination of these methods.



4 VALVE DATA PREFERRED TYPES

H TRANSMITTING VALVES AND MERCURY VAPOUR RECTIFIERS

QQV
04-20
(contd.)

OPERATING CONDITIONS (contd.)

As push-pull R.F. power amplifier, Class "B" telephony

V_a	400	V
V_{g2}	125	V
V_{g1}	-25	V
I_a	2×37.5	mA
I_{g2}	2×2.0	mA
$V_{in(pk)}$	2×25	V
P_{drive}	0.8	W
P_{out}	10.5	W

As push-pull grid-modulated Class "C" R.F. power amplifier

V_a	400	V
V_{g2}	125	V
V_{g1}	-40	V
I_a	2×37.5	mA
I_{g2}	2×1.5	mA
I_{g1}	2×0.2	mA
$V_{in(pk)}$ R.F.	2×40	V
$\uparrow V_{mod(pk)}$ A.F.	19	V
P_{drive}	0.32	W
P_{out}	10.5	W

As push-pull anode-modulated Class "C" R.F. power amplifier

V_a	325	V
* V_{g2}	165	V
R_{g2}	10	K Ω
V_{g1}	-45	V
** R_{g1}	11.25	K Ω
I_a	2×62	mA
I_{g2}	2×8	mA
I_{g1}	2×2	mA
$V_{in(pk)}$	2×56	V
P_{drive}	0.2	W
P_{out}	30	W

\uparrow For 100% modulation.

*May be obtained from a fixed supply or by a grid resistor of value shown.

**May be obtained from a separate supply or by a grid or cathode resistor of value shown, or by a combination of these methods.

As Class "AB₂" A.F. power amplifier or modulator

V_a	400	V
V_{g2}	125	V
V_{g1}	-15	V
I_{a0}	2×10	mA
I_a (max. sig.)	2×75	mA
I_{g2} (max. sig.)	2×16	mA
$V_{in(pk)}$	2×30	V
R_{n-a}	6.2	K Ω
* P_{drive}	0.36	W
P_{out}	42	W

*The effective resistance in the grid circuit should be below 500 Ω and the effective impedance should not exceed 700 Ω at the highest response frequency required.



BASE :
Octal

DIMENSIONS :
L=115 mm
D=59 mm



**TRANSMITTING VALVES AND
MERCURY VAPOUR RECTIFIERS**

The **QQV06-40** is a double tetrode having an oxide coated cathode. The valve is primarily intended for use as an R.F. amplifier or oscillator and has a rated anode dissipation of 20 W per anode. The limiting frequency of operation is approximately 300 Mc/s.

**QQV
06-40**

CATHODE

Indirectly heated for series or parallel operation.

	Series	Parallel	
V_h	12.6	6.3	V
I_h (approx.)	1.0	2.0	A

MOUNTING POSITION

Vertical—base up or down.

Horizontal—anode pins in horizontal plane.

CAPACITANCES

C_{g1-all} (each section)	11.0	$\mu\mu F$
C_{a-all} (each section)	3.5	$\mu\mu F$
C_{a-g1} (each section)	<0.1	$\mu\mu F$
* C_{out}	2.2	$\mu\mu F$
* C_{in}	6.6	$\mu\mu F$

*Two sections in push-pull.

CHARACTERISTICS (each section) measured at $I_a = 30$ mA

g_m	4.5	mA/V
μ_{g1-g2}	9	

LIMITING VALUES

V_a max.	600	V
p_a max.	2×20	W
V_{g2} max.	250	V
p_{g2} max.	2×3	W
I_{g1} max.	2×5	mA
p_{g1} max.	2×1	W
I_k max.	2×120	mA
i_k (pk) max.	2×480	mA
V_{g1} max.	-175	V
Max. temperature of pins	180	°C
Max. temperature of bulb	225	°C
Max. frequency at reduced ratings (V_a max. = 400 V)	300	Mc/s

NOTE—When the valve is used at maximum ratings above 150 Mc/s it is necessary to direct an air flow of up to $\frac{1}{2}$ cu. ft. per min. on to the top of the bulb. An anode connector providing adequate heat transfer by radiation or conduction should also be used.



4 VALVE DATA PREFERRED TYPES

H TRANSMITTING VALVES AND MERCURY VAPOUR RECTIFIERS

QQV 06-40 (contd.)

OPERATING CLASS "C"	CONDITIONS R.F. AMPLIFIER	AS OR	PUSH-PULL OSCILLATOR	
f	60	150	300	Mc/s
V _a	600	500	400	V
V _{g2}	250	250	200	V
V _{g1}	-100	-60	-60	V
I _a	2×100	2×100	2×100	mA
I _{g2}	2×9	2×9	2×6	mA
I _{g1}	2×2	2×1	2×1.5	mA
V _{in} (pk)	2×120	2×80	2×80	V
P _a	2×17	2×17.5	2×20	W
P _{out}	85	65	40	W
η	71	65	50	%

OPERATING CONDITIONS AS CLASS "C" PUSH-PULL FREQUENCY TREBLER

f _{out}	150	150	220	Mc/s
V _a	500	400	400	V
V _{g2}	250	250	250	V
V _{g1}	-150	-150	-150	V
I _a	2×55	2×65	2×60	mA
I _{g2}	2×4.5	2×7	2×9	mA
I _{g1}	2×3	2×2.5	2×1.5	mA
V _{in} (pk)	2×200	2×200	2×200	V
P _a	2×18.5	2×18	2×18.5	W
P _{out}	18	16	11	W
η	33	31	23	%

OPERATING CONDITIONS AS CLASS "C" ANODE AND SCREEN MODULATED R.F. POWER AMPLIFIER (Two systems in parallel)

f	<60	Mc/s
V _a	500	V
V _{g2}	225	V
V _{g2} (pk)	185	V
V _{g1}	-100	V
V _{in} (pk)	150	V
I _a	2×100	mA
I _{g2}	2×13	mA
I _{g1}	2×4.5	mA
P _{g2}	2×3	W
P _a	2×16	W
P _{out}	68	W
η	68	%
P _{mod}	50	W



BASE :
B7A

DIMENSIONS :
L=122 mm
D=50 mm



**TRANSMITTING VALVES AND
MERCURY VAPOUR RECTIFIERS**

Push-pull R.F. power tetrode with a maximum anode dissipation of 20 watts per section and primarily intended for use as a Class "C" amplifier or oscillator at frequencies up to 250 Mc/s.

The cathode is indirectly heated with centre tapped heater for series or parallel connection.

HEATER

	Series	Parallel	V
V_h	12.6	6.3	V
I_h	1.25	2.5	A

OUNTING POSITION

Vertical—base down Horizontal—plane of anodes vertical

ACITANCES

Each section

C_{in}	14.5	$\mu\mu F$
C_{out}	7.0	$\mu\mu F$
* C_{a-g1}	<0.12	$\mu\mu F$
C_{g2-k} (including internal by-pass capacitor)	65	$\mu\mu F$ approx.

*With external shield up to the flange seal

CHARACTERISTICS

Each section (at $I_a=60$ mA $V_a=750$ V $V_{g2}=225$ V)

g_m	8.5	mA/V
μ_{g1-g2}	9	

OPERATING CONDITIONS

As push-pull R.F. power amplifier or oscillator, Class "C" telegraphy

V_a	500	750	V
* V_{g2}	200	200	V
R_{g2}	9.3	18.3	K Ω
** V_{g1}	-45	-55	V
R_{g1-k}	3.75	4.6	K Ω
R_k	160	270	Ω
I_a	2×120	2×80	mA
I_{g2}	2×16	2×15	mA
I_{g1} (approx.)	2×6	2×6	mA
V_{in} (pk)	2×62	2×70	V
P_{drive} (approx.)	0.7	0.8	W
P_{out} (approx.)	83	87	W

4 Class "C" anode-modulated push-pull R.F. amplifier

V_a	425	600	V
* V_{g2}	200	200	V
R_{g2}	6.4	13.3	K Ω
** V_{g1}	-60	-70	V
R_{g1-k}	5.5	5.8	K Ω
I_a	2×106	2×75	mA
I_{g2}	2×18	2×15	mA
I_{g1} (approx.)	2×5.5	2×6	mA
V_{in} (pk)	2×77	2×86	V
P_{drive} (approx.)	0.8	0.9	W
P_{out} (approx.)	63	70	W



**H TRANSMITTING VALVES AND
MERCURY VAPOUR RECTIFIERS**

QQV
07-40
(contd.)

OPERATING CONDITIONS (contd.)

As Class "C" grid-modulated push-pull R.F. power amplifier

V_a	500	750	V
V_{g2}	200	200	V
V_{g1}	-38	-55	V
I_a	2×60	2×40	mA
I_{g2}	2×5	2×2.5	mA
I_{g1}	2×1	0	mA approx.
$V_{fn} (pk) (R.F.)$	2×41	2×52	V
$V_{mod} (pk)$	17	15	V
P_{drive}	0.5	0.7	W approx.
P_{out}	23	24	W approx.

*Obtained from separate supply or from anode supply through series resistor (R_{g2}) of value shown, in which case provision must be made to ensure that $V_{g2(b)}$ does not exceed 600 V.

**Obtained from fixed supply or by means of grid or cathode resistor of value shown, or by a combination of these methods.

LIMITING VALUES

V_a max.	750	V
p_a max.	2×20	W
$V_a (pk)$ max.	2,500	V
$V_{g2(b)}$ max.	600	V
V_{g2} max.	225	V
p_{g2} max.	2×3.5	W
I_{g2} max.	2×17	mA
I_k max.	2×145	mA
* $I_k (pk)$ max.	550	mA
V_{g1} max.	-175	V
I_{g1} max.	2×7.5	mA
* $I_{g1} (pk)$ max.	30	mA
* R_{g1-k} max.	30	K Ω
V_{h-k} max.	100	V
**Max. bulb temp.	175	$^{\circ}C$

*Per section.

**Forced air cooling may be required to limit the bulb temperature to the figure quoted. At normal dissipation an air flow of approx. 5 cu. ft./min. is required.

Operating frequency (Mc/s)	Max. anode voltage (V)	Max. anode input power (W)
100	750	120
150	700	120
200	600	120
250	500	100



BASE :
B7A

DIMENSIONS :
L=109 mm
D=61 mm



**TRANSMITTING VALVES AND
MERCURY VAPOUR RECTIFIERS**

**QQZ
04-15**

Quick-heating double tetrode with an oxide coated filament. It is primarily intended for mobile applications and has a rated anode dissipation of 8 watts, the limiting frequency being 186 Mc/s.

FILAMENT

Oxide coated, directly heated.

V_f	6.3	V
I_f	0.68	A
Heating time	2.0	Secs.

MOUNTING POSITION

Vertical—base upwards or downwards

CAPACITANCES

Each section

C_{a-g}	0.1	$\mu\mu F$
C_{g-f}	8	$\mu\mu F$
C_{a-f}	3	$\mu\mu F$

CHARACTERISTICS

Each section (measured at $I_a=20$ mA)

g_m	2	mA/V
μ_{g1-g2}	9	

**OPERATING CONDITIONS AS PUSH-PULL
CLASS "C" R.F. AMPLIFIER OR OSCILLATOR**

	Continuous operation		Intermittent operation		
	186	186	186	186	Mc/s
V_a	250	400	250	400	V
V_{g2}	175	200	175	200	V
V_{g1}	-70	-80	-70	-80	V
I_a	2×30	2×30	2×40	2×40	mA
I_{g2}	2×4	2×4	2×5	2×5	mA
I_{g1}	2×1.5	2×1.5	2×1.75	2×1.75	mA
V_{in} (pk)	2×60	2×65	2×60	2×65	V
P_a	2×3	2×4.75	2×4	2×6.25	W
P_{out}	9	14.5	12	19.5	W
η	60	61	60	61	%
$\dagger P_{load}$	7.7	12.4	10.2	16.5	W

\dagger These figures assume a circuit efficiency of 85%

**OPERATING CONDITIONS AS PUSH-PULL
CLASS "C" FREQUENCY TREBLER**

	$f=62-186$ Mc/s		$f=33-100$ Mc/s		
	Intermittent operation	Continuous operation	Intermittent operation	Continuous operation	
V_a	250	250	350	350	V
V_{g2}	200	200	200	200	V
V_{g1}	-180	-180	-180	-180	V
I_a	2×40	2×30	2×30	2×24	mA
I_{g2}	6	6	6	6	mA
I_{g1}	2×1.5	2×1.5	2×1.5	2×1.5	mA
P_{out}	5	3.75	6	4.8	W
$\dagger P_{load}$	3.5	3	5	3.8	W

\dagger These figures assume normal circuit efficiencies.



4 VALVE DATA PREFERRED TYPES

H TRANSMITTING VALVES AND MERCURY VAPOUR RECTIFIERS

QQZ LIMITING VALUES

04-15
(contd.)

Continuous operation

V_a max.	400	V
p_a max.	2×6	W
V_{g2} max.	250	V
p_{g2} max.	2×2	W
I_k max.	2×40	mA
i_k (pk) max.	2×160	mA
V_{g1} max.	-250	V
I_{g1} max.	2×5	mA
R_{g1-f} max. (each section)	0.5	MΩ
Max. operating frequency at full ratings	186	Mc/s
Max. temperature of base pins	80	°C
Max. temperature of bulb	200	°C

Intermittent operation (other limiting values as for continuous operation)

p_a max.	2×8	W
p_{g2} max.	2×2.5	W
I_k max.	2×50	mA
i_k (pk) max.	2×200	mA
Max. temperature of base pins	100	°C
Max. temperature of bulb	250	°C



BASE :
B8G

DIMENSIONS :
L=100 mm
D=32 mm

RGI-240A Mercury vapour rectifier

FILAMENT

V_f 4.0 V I_f 2.7 A approx.

LIMITING VALUES

Max. peak inverse voltage (150 c/s max.)	6,500	V
Max. peak anode current	1,250	mA
Max. mean anode current	250	mA
Voltage drop across valve	16	V approx.
Ambient temperature	10 to 40	°C
Condensed mercury temperature	25 to 65	°C



TRANSMITTING VALVES AND MERCURY VAPOUR RECTIFIERS

FULL LOAD OPERATING CONDITIONS

RG1-240A
(contd.)

Circuit	No. of Valves	Full load D.C. output		Applied A.C. volts	Initial filter Elements	
		(V)	(mA)	(V_{rms})	L henries (min.)	C μF (max.)
Single phase full wave	2	2,000	500	2,220 (per valve)	7.0	5.0
Single phase bridge	4	4,000	500	4,440 (total)	14.0	2.5
Three phase half wave	3	2,750	750	2,350 (per phase)	2.5	2.0
Three phase full wave	6	6,000	750	2,570 (per phase)	5.0	1.0

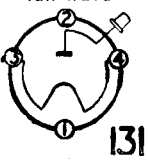

BASE :
British
4-pin

DIMENSIONS :
L=139 mm
D=48 mm

Mercury vapour rectifier FILAMENT

V_f 2.5 V I_f 5.0 A approx.

RG3-250

LIMITING VALUES

Max. peak inverse voltage (150 c/s max.)	10,000	V
Max. peak anode current	1.0	A
Max. mean anode current	0.25	A
Voltage drop across valve	16 V approx.	
Ambient temperature	10 to 40	$^{\circ}C$
Condensed mercury temperature	25 to 65	$^{\circ}C$

FULL LOAD OPERATING CONDITIONS

Circuit	No. of valves	Full Load D.C. output		Applied A.C. volts	Initial Filter elements	
		(V)	(mA)	(V_{rms})	L henries (min.)	C μF (max.)
Single phase full wave	2	3,150	500	3,500 (per valve)	10	2
Single phase bridge	4	6,300	500	7,000 (total)	20	1
Three phase half wave	3	4,100	750	3,500 (per phase)	6.0	1
Three phase full wave	6	9,500	750	4,000 (per phase)	10	0.5

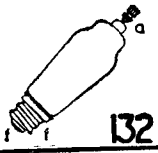

BASE :
Standard Edison
Screw

DIMENSIONS :
L=138 mm
D=48 mm



NEON STABILISING TUBES

Type	Description	Burning Voltage (V)				Page
4687	Neon Stabilising Tube	90-110	154
4687A	Neon Stabilising Tube	90-110	154
475	Neon Stabilising Tube	90-110	154
85A1	Voltage Reference Tube	83-86	155



4 VALVE DATA PREFERRED TYPES

I NEON STABILISING TUBES

4687 Neon-filled stabilising tube

OPERATING CONDITIONS

V ignition max.	130 V
V burning	90-110 V
I quiescent	20 mA
I max.	40 mA
I min.	10 mA
A.C. resistance max.	250 Ω

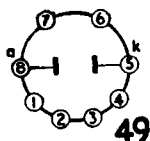

BASE :
P-base

DIMENSIONS :
L=87 mm
D=29 mm

4687A Neon-filled stabilising tube, identical with the 4687 except that it has a British 4-pin base

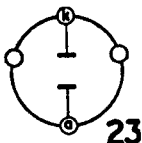

BASE :
British
4-pin

DIMENSIONS :
L=102 mm
D=29 mm

7475 Neon-filled stabilising tube

OPERATING CONDITIONS

V ignition max.	140 V
V burning	90-110 V
I quiescent	4 mA
I max.	8 mA
I min.	1 mA
A.C. resistance max.	300 Ω

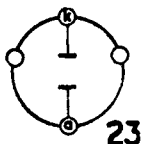

BASE :
British
4-pin

DIMENSIONS :
L=85 mm
D=31 mm



Neon-filled two-electrode tube having a high order of stability over both long and short periods and very small variations from valve to valve

85A1

PREFERRED OPERATING CONDITION

I (quiescent) 4.5 ± 0.2 mA

CHARACTERISTICS

At preferred operating condition

A.C. resistance	290	Ω
V (burning) variation from valve to valve	83-86	V
Temperature co-efficient of V (burning)	-1.8	mV/°F
Max. percentage variation of V (burning) for current change of 4.3-4.7 mA	0.17	%
Max. percentage variation of V (burning) during life	0.5	%
Max. percentage variation of V (burning) after the first 300 hours of life	0.2	%
Max. short term (100 hours max.) variation of V (burning) after the first 300 hours of life	0.1	%

Equilibrium conditions are normally reached after 3 minutes operation.

Over life, the A.C. resistance will remain sensibly constant but the temperature co-efficient of burning voltage can be expected to decrease slightly.

The noise generated by the valve over a frequency band of 30-10,000 c/s, is of the order of 70 μV which is equivalent to the noise generated by a resistance of approximately 30 MΩ. The noise is evenly distributed over the frequency range.

The tube should not be subjected to shock or continuous vibration.

LIMITING CONDITIONS

V (ignition) max.	125	V
V (burning)	83-87	V
I max.	8	mA
I min.	1	mA
A.C. resistance max.	450	Ω

BASE:

B8G
Anode to pin 2
Cathode to pins 4 and 8

DIMENSIONS:

L=80 mm
D=32 mm



OSCILLOSCOPE AND PICTURE TUBES **J**

OSCILLOSCOPE AND PICTURE TUBES

Type	Description		Page
DB4-2	1 $\frac{3}{4}$ in.	Oscilloscope Tube. Short persistence ...	158
DG4-2	1 $\frac{3}{4}$ in.	Oscilloscope Tube. Medium persistence ...	158
DR4-2	1 $\frac{3}{4}$ in.	Oscilloscope Tube. Long persistence ...	158
DB7-5	2 $\frac{3}{4}$ in.	Oscilloscope Tube. Short persistence ...	159
DG7-5	2 $\frac{3}{4}$ in.	Oscilloscope Tube. Medium persistence ...	159
DR7-5	2 $\frac{3}{4}$ in.	Oscilloscope Tube. Long persistence ...	159
DB7-6	2 $\frac{3}{4}$ in.	Oscilloscope Tube. Short persistence. For asymmetric operation ...	160
DG7-6	2 $\frac{3}{4}$ in.	Oscilloscope Tube. Medium persistence. For asymmetric operation ...	160
DR7-6	2 $\frac{3}{4}$ in.	Oscilloscope Tube. Long persistence. For asymmetric operation ...	160
ECR30	3 in.	Oscilloscope Tube. Medium persistence ...	161
ECR35	3 $\frac{1}{2}$ in.	Oscilloscope Tube. Medium persistence ...	161
ECR35P	3 $\frac{1}{2}$ in.	Oscilloscope Tube. Long persistence ...	161
ECR60	6 in.	Oscilloscope Tube. Medium persistence. ...	162
MW6-2	2 $\frac{1}{2}$ in.	Picture Tube for Projection Television...	163
MW22-14	9 in.	Picture Tube. Coated B8G Base ...	164
MW22-14C	9 in.	Picture Tube. Uncoated B8G Base ...	164
MW22-17	9 in.	Picture Tube. Uncoated B12A Base ...	164
MW22-18	9 in.	Picture Tube. Coated B12A Base ...	164
MW31-14C	12 in.	Picture Tube. Uncoated B8G Base ...	165
MW31-17	12 in.	Picture Tube. Uncoated B12A Base ...	165
MW31-18	12 in.	Picture Tube. Coated B12A Base ...	165



4 VALVE DATA PREFERRED TYPES

J OSCILLOSCOPE AND PICTURE TUBES

DB4-2 High Vacuum Oscilloscope Tubes with
DG4-2 $1\frac{1}{2}$ in. diameter screens.
DR4-2

*Preliminary
Data*

HEATER	V_h	6.3	V
	I_h	0.4	A

CAPACITANCES

$C_{y'-all}$	4.4	$\mu\mu F$
$C_{y''-all}$	4.4	$\mu\mu F$
$C_{x'-all}$	5.0	$\mu\mu F$
$C_{x''-all}$	5.4	$\mu\mu F$
$C_{y'y''-all}$	0.5	$\mu\mu F$
$C_{x'x''-all}$	0.8	$\mu\mu F$
$C_{y'y''-x'x''}$	0.1	$\mu\mu F$
C_g-all	9.0	$\mu\mu F$

LUMINESCENT COLOUR

DB4-2	Blue. Short persistence
DG4-2	Green. Medium persistence
DR4-2	Long persistence

DEFLECTION

Double electrostatic
Y plates suitable for symmetrical operation
X plates suitable for asymmetrical operation

FOCUSING Electrostatic

OPERATING CONDITIONS

V_{a2}	800	1,000	V
V_{a1}	200 to 300	260 to 360	V
$*V_g$	0 to -50	0 to -60	V

* Grid must never be allowed to become positive with respect to the cathode

DEFLECTION SENSITIVITY

V_{a2}	800	1,000	V
X plates	0.16	0.13	mm/V
Y plates	0.26	0.21	mm/V

LIMITING VALUES

V_{a2} max.	1,000	V
V_{a2} min.	800	V
V_{a1} max.	360	V
V_g max.	0	V
$-V_{g1}$ max.	60	V
$V_{x'-x''}$ (pk) max.	750	V
$V_{y'-y''}$ (pk) max.	450	V
p_t max.	3	mW/cm ²
R_{g-k} max.	0.5	M Ω

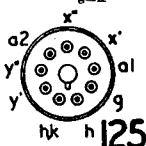

BASE
B9G

DIMENSIONS :
L=160 mm
D= 44 mm



OSCILLOSCOPE AND PICTURE TUBES

High Vacuum Oscilloscope Tubes with
2 3/4 in. diameter screens

DB7-5
DG7-5
DR7-5

*Preliminary
Data*

HEATER

V_h	6.3	V
I_h	0.4	A

CAPACITANCES

$C_{y'-all}$	4.4	$\mu\mu F$
$C_{y''-all}$	4.4	$\mu\mu F$
$C_{x'-all}$	5.0	$\mu\mu F$
$C_{x''-all}$	5.4	$\mu\mu F$
$C_{y'y''-all}$	0.6	$\mu\mu F$
$C_{x'x''-all}$	0.6	$\mu\mu F$
$C_{y'y''-x'x''}$	0.1	$\mu\mu F$
C_{g-all}	9.0	$\mu\mu F$

LUMINESCENT COLOUR

DB7-5	Blue. Short persistence
DG7-5	Green. Medium persistence
DR7-5	Long persistence

DEFLECTION

Double electrostatic
Tubes suitable for symmetrical operation

FOCUSING Electrostatic

OPERATING CONDITIONS

V_{a2}	800	V
V_{a1}	200 to 300	V
$*V_g$	0 to -50	V

* Grid must never be allowed to become positive with respect to the cathode

DEFLECTION SENSITIVITY ($V_{a2}=800$ V)

X plates	0.16	mm/V
Y plates	0.26	mm/V

LIMITING VALUES

V_{a2} max.	1,000	V
V_{a2} min.	800	V
V_{a1} max.	400	V
V_g max.	0	V
$-V_g$ max.	100	V
$V_{x'-x''}$ (pk) max.	750	V
$V_{y'-y''}$ (pk) max.	450	V
p_t max.	3	mW/cm ²
R_{g-k} max.	0.5	M Ω



BASE :
B9G

DIMENSIONS :

D=160 mm
D= 71 mm



**DB7-6
DG7-6
DR7-6**

**High Vacuum Oscilloscope Tubes with
2½ in. diameter screens**

*Preliminary
Data*

HEATER	V_h	6.3	V
	I_h	0.4	V

CAPACITANCES

$C_{y'-all}$	4.4	$\mu\mu F$
$C_{y''-all}$	4.4	$\mu\mu F$
$C_{x'-all}$	5.0	$\mu\mu F$
$C_{x''-all}$	5.4	$\mu\mu F$
$C_{y'y''-all}$	0.5	$\mu\mu F$
$C_{x'x''-all}$	0.8	$\mu\mu F$
$C_{y'y''-x'x''}$	0.1	$\mu\mu F$
C_{g-all}	9.0	$\mu\mu F$

LUMINESCENT COLOUR

DB7-6	Blue. Short persistence
DG7-6	Green. Medium persistence
DR7-6	Long persistence

DEFLECTION

- Double electrostatic
- Y plates suitable for symmetrical operation
- *X plates suitable for asymmetrical operation
- * It is essential that plate x'' be connected to a2

FOCUSING Electrostatic

OPERATING CONDITIONS

V_{B2}	800	V
V_{B1}	200 to 300	V
* V_g	0 to -50	V

* Grid must never be allowed to become positive with respect to the cathode

DEFLECTION SENSITIVITY ($V_{B2}=800$ V)

X plates	0.16	mm/V
Y plates	0.26	mm/V

LIMITING VALUES

V_{B2} max.	1,000	V
V_{B2} min.	800	V
V_{B1} max.	400	V
V_g	0	V
$-\bar{V}_g$ max.	100	V
$V_{x'-x''}$ (p.k) max.	750	V
$V_{y'-y''}$ (p.k) max.	450	V
p_i max.	3	mW/cm ²
R_{g-k} max.	0.5	M Ω

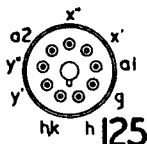

BASE :
B9G

DIMENSIONS :
L=160 mm
D= 71 mm



OSCILLOSCOPE AND PICTURE TUBES J

Oscilloscope tube with 3 in. diameter screen

ECR 30

HEATER

V_h 4.0 V I_h 1.0 A

CAPACITANCES

Grid to all other electrodes	<20	$\mu\mu\text{F}$
Each X plate or each Y plate to all other electrodes	<15	$\mu\mu\text{F}$
One X plate to one Y plate	<3	$\mu\mu\text{F}$

LUMINESCENT COLOUR

Green—medium persistence

DEFLECTION

Electrostatic. The tube is primarily intended for symmetrical deflection

OPERATING CONDITIONS

$V_{a1} = V_{a2}$	800	V
V_{a2}	100 to 170	V
V_g	-1.0 to -18	V

LIMITING VALUES

$V_{a1} = V_{a2}$ max.	1,000	V
V_{h-k} max.	50	V

DEFLECTION SENSITIVITY

X and Y plates $\frac{170}{V_{a2}}$ mm/V

Viewed from the screen end and with the tube positioned so that spigot key of the base is uppermost, a positive voltage on X' will deflect the spot to the left and a positive voltage on Y' will deflect the spot upwards.

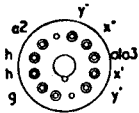

114

BASE :
B12B

DIMENSIONS :
L=206 mm
D=70 mm

High-sensitivity oscilloscope tube with 3½ in. diameter screen

ECR 35
ECR 35P

HEATER

V_h 4.0 V I_h 1.0 A

CAPACITANCES

Grid to all other electrodes	<25	$\mu\mu\text{F}$
Each X plate or each Y plate to all other electrodes	<25	$\mu\mu\text{F}$
One X plate to one Y plate	<5	$\mu\mu\text{F}$

LUMINESCENT COLOUR

ECR 35 Green—medium persistence
ECR 35P Blue—with yellow-green afterglow; long persistence



4 VALVE DATA PREFERRED TYPES

J OSCILLOSCOPE AND PICTURE TUBES

ECR 35 DEFLECTION

ECR 35P (contd.)

Electrostatic. The tube is suitable for either symmetrical or asymmetrical deflection.

With asymmetrical deflection the trapezoidal distortion is such that the angle between adjacent sides of a 45 mm x 70 mm raster is between 85° and 95°.

OPERATING CONDITIONS

$V_{a1} = V_{a2}$	1,200	V
V_{a2}	150-250	V
V_g	-1.0 to -50	V

LIMITING VALUES

$V_{a1} = V_{a3}$ max.	2,500	V
V_{h-k} max.	50	V

DEFLECTION SENSITIVITY

X plates	$\frac{360}{V_{a3}}$ mm/V
Y plates	$\frac{780}{V_{a3}}$ mm/V

Viewed from the screen end and with the tube positioned so that the spigot key of the base is uppermost, a positive voltage on X' will deflect the spot to the left and a positive voltage on Y' will deflect the spot upwards.



BASE :
B12D

DIMENSIONS :
L=341 mm
D=90 mm

ECR 60 High-sensitivity oscilloscope tube with 6 in. diameter screen

HEATER

V_h 4.0 V I_h 1.0 A

CAPACITANCES

Grid to all other electrodes	<25	$\mu\mu\text{F}$
Each X plate or each Y plate to all other electrodes	<25	$\mu\mu\text{F}$
One X plate to one Y plate	<5	$\mu\mu\text{F}$

LUMINESCENT COLOUR

Green—medium persistence

DEFLECTION

Electrostatic. The tube is suitable for either symmetrical or asymmetrical deflection.

With asymmetrical deflection the trapezoidal distortion is such that the angle between adjacent sides of an 80 mm x 80 mm raster is between 85° and 95°.



OSCILLOSCOPE AND PICTURE TUBES **J**

OPERATING CONDITIONS

$V_{b1} = V_{a3}$	2,000	V
V_{a2}	250 to 450	V
V_g	-1.0 to -100	V

ECR 60
(contd.)

LIMITING VALUES

$V_{b1} = V_{a3}$ max.	2,500	V
V_{h-k}	50	V

DEFLECTION SENSITIVITY

X plates	$\frac{600}{\sqrt{V_{a3}}}$	mm/V
Y plates	$\frac{1,150}{\sqrt{V_{a3}}}$	mm/V

Viewed from the screen end and with the tube positioned so that the spigot key of the base is uppermost, a positive voltage on X' will deflect the spot to the left and a positive voltage on Y' will deflect the spot upwards.

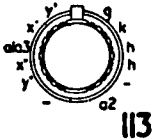

BASE :
B12D

DIMENSIONS :
L=432 mm
D=160 mm

Picture Tube with 2½ in. diameter metal-backed screen,
for use in Projection Television

MW6-2

HEATER

V_h 6.3 V I_h 0.3 A Suitable for series or parallel operation

Important Note.—When used in a series heater chain the surge heater voltage must not exceed 8.5 V (r.m.s.) when the supply is switched on. A current limiting device should therefore be included in the circuit to ensure that this voltage is not exceeded.

MOUNTING POSITION

The tube may be mounted in any position except screen downward with the axis at an angle of less than 50° to the vertical.

EXTERNAL CONDUCTIVE COATING

This tube has an external conductive coating designated M, which must be connected to chassis. The capacitance of this coating to the anode may be used to provide smoothing for the E.H.T. supply.

SPARK TRAP

An internal spark trap, which must be connected to chassis, prevents flash-over between anode and grid within the tube.

CAPACITANCES

C_{g-a11}	6.3	$\mu\mu\text{F}$
C_{k-a11}	6.3	$\mu\mu\text{F}$
C_{a-M}	450	$\mu\mu\text{F}$



4 VALVE DATA PREFERRED TYPES

J OSCILLOSCOPE AND PICTURE TUBES

MW6-2 SCREEN Metal-backed
(contd.)

LUMINESCENT COLOUR

White.

The picture diameter must not exceed 57.5 mm

FOCUSING AND DEFLECTION

Magnetic

The number of ampere-turns required for focusing at $V_a=25KV$ and with an air-gap of 11 to 13 mm in the magnetic circuit is 920.

The inner diameter of the focus coil should be 27.5 mm, and provision should be made for adjusting in through 2.5 to 3° in both the horizontal and vertical directions for picture centering.

The deflection angle is 38°

TYPICAL OPERATING CONDITIONS

V_a	25	KV
I_a (av)	100	μA
* V_g for cut-off	-40 to -90	V

*In no circumstances must the grid be allowed to become positive with respect to the cathode

LIMITING VALUES

V_a max.	25	KV
** V_{h-k} max.	± 125	V

** It is necessary to ensure that this value is not exceeded during the warming up period immediately after switching on.

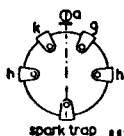

117

BASE :
V

DIMENSIONS

L=268 mm
D= 65 mm

MW22-14 Television picture tubes with 9 in. diameter screen.
These tubes are suitable for series operation

MW22-14C HEATER

MW22-17 V_h 6.3 V I_h 0.3 A

MW22-18

Important Note.—The heater voltage must not exceed 8.5 V when the supply is switched on. If the heater is connected in series with the heaters of other valves a current limiting device should be included in the circuit to ensure that this voltage is not exceeded.

CAPACITANCES

C_{g-all}	<10	$\mu\mu F$
C_{k-all}	<10	$\mu\mu F$
C_{a2-M}	1,000	$\mu\mu F$



VALVE DATA **4**
PREFERRED TYPES **J**

OSCILLOSCOPE AND PICTURE TUBES

EXTERNAL CONDUCTIVE COATING

Types MW 22-14 and MW 22-18 have an external conductive coating designated M which must be earthed. The capacitance C_{a_2-M} may be used to provide smoothing for the EHT supply.

Types MW 22-14C and MW 22-17 have no external conductive coating

MW22-14

MW22-14C

MW22-17

MW22-18

(contd.)

FLUORESCENT COLOUR

White

FOCUSING AND DEFLECTION Magnetic

With the centre of the deflector coils 204 mm from the centre of the screen, the deflection sensitivity at $V_{a_2}=7$ KV is $0.08 \times L$ mm/gauss.

Where L =length of the electron path through the field of the deflector coil in mm.

TYPICAL OPERATING CONDITIONS

V_{a_2}	7.0	KV
V_{a_1}	200	V
* V_{g_1} for cut-off	-40	V
Focusing ampere-turns	650 approx.	

*In no circumstances must the grid be allowed to become positive with respect to the cathode.

LIMITING VALUES

V_{a_2} max.	9.0	KV
V_{a_1} max.	400	V
I_{a_2} max.	100	μ A
V_{h-k} max.	150	V

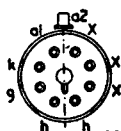

115

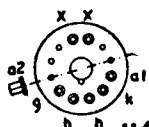

116

DIMENSIONS : $L=376$ mm $D=230$ mm

BASES :

MW 22-14	MW 22-17
MW 22-14C	MW 22-18
B8G (115)	B12A (116)

Television picture tubes with 12 in. diameter screens

MW31-14C

HEATER

MW31-17

V_h 6.3 V I_h 0.3 A. Suitable for series operation, D.C. or A.C.

MW31-18

Note.—The heater voltage must not exceed 8.5 when the supply is switched on. If the heater is connected in series with the heaters of other valves a current limiting device should be included in the circuit to ensure that this voltage is not exceeded.



GAS-FILLED TRIODES AND TETRODES

GAS-FILLED TRIODES AND TETRODES

Type	Description	Page
EN31	Thyratron for use in H.F. Time Bases and Control Equipment...	168
1267	Cold-cathode Gas-filled Triode	168
2D21	Gas-filled Tetrode Primarily intended for use in Relay or Grid Controlled Rectifier Circuits	160



EN 31 Thyatron for use in H.F. time bases and control equipment

HEATER

V_h 6.3 V I_h 1.3 A

CAPACITANCES

C_{in}	6.1	$\mu\mu F$
C_{out}	4.2	$\mu\mu F$
C_{a-g}	2.3	$\mu\mu F$
C_{g-h}	< 1.5	$\mu\mu F$

OPERATING CONDITIONS

As triode

V_{a-g} (pk) max.	1,500	V
V_a (pk) max.	1,000	V
I_a max.	10	mA
i_a pk. max.	750	mA
R_g min.	750	Ω/V
R_g max.	0.75	M Ω
* V_{h-k} max.	100	V
Valve voltage drop	33	V
Control ratio	35	
Max. operating frequency	150	Kc/s

*Cathode always positive with respect to heater.

As half wave rectifier (grid connected to cathode)

V_a max.	350	V
I_{out} max.	40	mA
Min. limiting resistance	100	Ω
Max. reservoir capacitance	6	μF
V_{h-k} max.	100	V

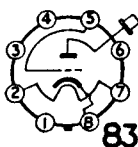

BASE :
Octal

DIMENSIONS :
L=114 mm
D=42 mm

1267 Cold-cathode gas-filled triode

CHARACTERISTICS

Max. operating anode voltage (starter anode connected to cathode)	225	V
Min. starter anode-cathode breakdown voltage	70	V
Max. starter anode-cathode breakdown voltage	90	V
Max. starter anode current for anode breakdown ($V_a = 140$ V)	100	μA
Starter anode to cathode voltage drop	60	V
Anode to cathode voltage drop	70	V
Max. peak cathode current	100	mA
Max. D.C. cathode current	25	mA

BASE : Octal **DIMENSIONS :** L=100 mm D=31 mm
Cathode to Pin 2 Anode to Pin 5 Grid to Pin 7



GAS FILLED TRIODES AND TETRODES

Gas-filled tetrode primarily intended for use in relay or
rid controlled rectifier circuits

2D21

HEATER

	Min.	Av.	Max.	
V_h	5.7	6.3	6.9	V
$I_h (V_a = 6.3V)$	0.54	0.6	0.66	A

Suitable for use on either D.C. or A.C.
Heating time 10 secs.

CAPACITANCES

Measured without external shield

C_{a-g_1}		0.03	μμF
C_{1a}		2.5	μμF
C_{out}		1.6	μμF

CHARACTERISTICS

Anode voltage drop		8	V
Grid 1 control ratio ($R_{g_1} = 0 \Omega$ $V_{g_2} = 0V$)		250	approx.
Grid 2 control ratio ($R_{g_1} = 0 \Omega$ $V_{g_2} = 0V$)		1,000	approx.

TYPICAL OPERATING CONDITIONS

For relay applications

Anode voltage (r.m.s.)		400	V
Grid 2 voltage		0	V
Grid 1 voltage (D.C.)		-6	V
Grid 1 signal voltage (pk.)		6	V
Grid 1 circuit resistance		1.0	M Ω
Anode circuit resistance*		2,000	Ω

*Sufficient resistance must be used to avoid exceeding
the limiting current values.

LIMITING VALUES

Peak anode voltage : Forward max.		650	V
Inverse max.		1,300	V
Grid 2 voltage :			
Peak before anode conduction max.		-100	V
*Average during anode conduction max.		-10	V
Grid 1 voltage :			
Peak before anode conduction max.		-100	V
*Average during anode conduction max.		-10	V
Cathode current : Peak max.		0.5	A
*Average max.		0.1	A
Surge for 0.1 second max.		10	A
Grid 2 current : *Average max.		0.01	A
Grid 1 current : *Average max.		0.01	A
Peak heater-cathode voltage :			
Heater negative max.		100	V
Heater positive max.		25	V
Ambient temperature range		-75 to +90	°C

*Averaged over any 30 second interval.

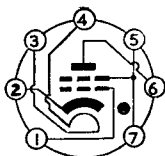

BASE :
B7G

DIMENSIONS :
L = 54mm
D = 19mm



PHOTOGRAPHIC FLASH TUBES

CHARACTERISTICS	TYPES			
	LSD2	LSD3* LSD3A*	LSD4*	LSD7*
Max. energy of discharge (joules)	56	100	400	200
Operating voltage (V)	7,000-10,000	2,000-2,700	2,000-2,700	2,000-2,700
Trigger voltage (V) min.	5,000	3,000	3,000	3,000
Approx. flash duration (micro-seconds)	1	150	300	250
Peak light output (lumens)	100×10^6	40×10^6	66×10^6	60×10^6
Integrated light output (lumen-seconds)	1,500	4,000	26,000	10,000
Efficiency (lumens/watt)	27	40	65	50
Effective tube resistance (Ω)	0.5	4.5	3.0	3.5
Size : Length (mm) Diameter (mm)	140 33	100 35	169 71	110 35
BASE	ESB Anode to top cap Cathode to centre base contact Trigger to thread	LSD3 4-pin UX (110) LSD3A 3-pin 5 Amp (111)	3-pin (112)	4-pin UX (110)

* Data taken at operating voltage=2.6 KV.

GENERAL NOTES

The recommended mode of operation is to arrange that the anode and trigger are at chassis potential, whilst the cathode is negatively live. If the cathode and trigger are at chassis potential and the anode is live, the tube may break down at voltages below 3 KV in the case of Types LSD 3, LSD 3A, LSD 4 and LSD 7.

Very great care must be taken not to exceed the maximum voltage at which a given capacitor delivers the stated maximum number of joules. The energy in joules stored in a capacitor is proportional to the square of the voltage ($\frac{1}{2}CV^2$ where C is in farads) and it is therefore easy to overload and damage the tube by exceeding the maximum voltage.

It is insufficient to rely upon the stated voltage of the transformer employed. In all cases the voltage which is applied to the tube should be measured by means of a high grade voltmeter.

A suitable operating circuit is given on page 247

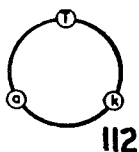
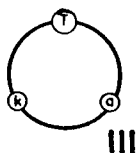
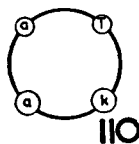

*TYPES	20 AV	20 CG	20 CV	52 CG	55 CG	90 A、	90 CG	90 CV
SENSITIVITY	Daylight and bluish light	Incandescent light and near infra-red	Incandescent light and near infra-red	Incandescent light and near infra-red	Incandescent light and near infra-red	Daylight and bluish light	Incandescent light and near infra-red	Incandescent light and near infra-red
CATHODE	CA	COS	COS	COS	COS	CA	COS	COS
Surface	11	6.7	6.7	4	2.2	4	3.0	3.0 sq. cm.
Projected area	1.7	1.05	1.05	0.62	0.34	0.62	0.47	0.47 sq. in.
CAPACITANCE								
C _{a-k}	0.2	1.5	1.5	1.3	2.3	0.6	1.1	0.8
								μμF
CHARACTERISTICS								
Max. Dark Current } at 150	0.05	0.1	0.05	0.1	0.1	0.05	0.1	0.05
Sensitivity	45†	150‡	25†	125‡	125‡	45†	125‡	20†
Gas Amp. factor max....	—	10	—	10	10	—	10	—
LIMITING VALUES								
V _{ag(b)} max.	150	90	250	90	90	100	90	100
I _g max.	10	5	20	3	2	5	2	10
Ambient temperature max.	70	100	100	100	100	70	100	100
BASE	B8G (106)	B8G (107)	B8G (107)	A	B3A	B7G (108)	B7G (109)	B7G (109)
DIMENSIONS								
Height to centre of cathode (cell seated)	80	80	80	75	63	54	54	54
	32	32	32	26.5	17	19	19	19
	23	32	32	41	35	12	20	20

* The letter "V" in the type number indicates a vacuum cell and "G" indicates a gas-filled type.
 † Sensitivity measured with a lamp of colour temperature 2,700°K.
 ‡ Sensitivity measured with a lamp of colour temperature 2,700°K and with a series resistor of 1 MΩ.
 CA=Caesium-antimony. COS=Caesium-on-oxidised-silver.

VALVE DATA
CURRENT MAINTENANCE TYPES **5**

2 VOLT MISCELLANEOUS TYPES

Type	Description	Base*	Working Conditions					Characteristics at Working Conditions			Optimum Load (kg)	
			If (A)	Va (V)	Vg2 (V)	-Vg1 (V)	Ia (mA)	ra (ohms)	μ	gm or gc (mA/V)		Pout (W)
FC2	Octode Frequency Changer...	7-pin (32)	0.1	135	135 ^{††}	0	0.95	—	—	0.2	—	—
FC2A	Octode Frequency Changer...	7-pin (32)	0.13	135	135 [†]	0.5	0.7	2,500,000	—	0.27	—	—
PM12M	Vari- μ Tetrode (M. or C.)	4-pin (4)	0.18	150	90	0.7	2.5	—	—	1.4	—	—
VP2	Vari- μ R.F. Pentode	7-pin (24)	0.18	135	135	0.7	3.0	400,000	—	1.5	—	—
VP2B	Vari- μ R.F. Hexode	7-pin (28)	0.14	135	60 [†]	1.5-7.5	2.0	1,300,000	—	1.4	—	—
SP2	R.F. Pentode ...	7-pin (24)	0.18	135	135	0	3.0	700,000	1,200	1.8	—	—
PM2HL	Medium Impedance Triode (M. or C.)	4-pin (3)	0.1	135	—	1.5	2.2	21,500	30	1.4	—	—
TDD2A	Double Diode Triode	5-pin (10)	0.12	135	—	1.5	1.95	25,000	30	1.2	—	—
PM2A	Output Triode	4-pin (3)	0.2	135	—	6.0	5.0	6,000	12	2.0	0.15	7
PM202	Super-Power Triode	4-pin (3)	0.2	150	—	14	14.0	2,000	7	3.5	—	3.7
PM2B	Class B Double Triode	7-pin (22)	0.2	120	—	0	3.0	—	—	—	1.25	14
PM22A	Output Pentode	5-pin (11)	0.15	135	135	4.5	5.6	150,000	—	2.2	0.35	19
QP22B	Double Output Pentode	7-pin (35)	0.3	120	120	10.2	3.3	—	—	2.6***	0.94	16

* Numbers in brackets in "Base" Column refer to the Base Diagrams. †† Max. Ratings. *** Measured at Va = Vg2 = 100V; Vg1 = 0
+ Vg3 + ± 5 = 45V. † Vg3 + ± 5 = 70V.

5 VALVE DATA

CURRENT MAINTENANCE TYPES

4 VOLT MISCELLANEOUS TYPES

Type	Description	Base*	Working Conditions				Characteristics at Working Conditions				P _{out} (W)	Optimum Load (kg)
			I _f or I _h (A)	V _a (V)	V _{g2} (V)	-V _{g1} (V)	I _a (mA)	r _a (ohms)	μ	g _m or g _c (mA/V)		
FC4	Octode Frequency Changer ...	7-pin (34)	0.65	250	90†	1.5	1.6	—	—	0.6	—	—
TH4B	Triode Heptode ...	7-pin (31)	1.45	250	100	2.5	3.25	1,500,000	—	0.75	—	—
SP4	R.F. Pentode (M. or C.) ...	{ 5-pin (13) 7-pin (27) }	1.0	200	100	2.0	3.0	2,200,000	5,000	2.3	—	—
SP4B	R.F. Pentode ...	7-pin (26)	0.65	250	250	2.4	4.0	2,000,000	6,800	3.4	—	—
VP4	Vari- μ R.F. Pentode ...	{ 5-pin (13) 7-pin (27) }	1.0	200	100	2.50	4.5	1,000,000	2,300	2.3	—	—
VP4A	Vari- μ R.F. Pentode ...	{ 5-pin (13) 7-pin (27) }	1.2	200	100	2.25	4.25	1,400,000	3,500	2.5	—	—
VP4B	Vari- μ R.F. Pentode ...	7-pin (26)	0.65	250	250	3.0	11.5	—	—	2.0	—	—
2D4A	Double Diode ...	5-pin (8)	0.65	200	—	—	0.8	—	—	—	—	—
TDD4	Double Diode Triode ...	7-pin (20)	0.65	250	—	7.0	4.0	13,500	27	2.0	—	—
TT4	Low Impedance Triode... ..	5-pin (9)	1.0	250	—	16.0	20.0	3,300	10.5	3.2	0.5	10
354V	Med. Impedance Triode (M. or C.) ...	5-pin (9)	0.65	250	—	4.5	6.5	11,500	40	3.5	—	—
Pen4DD	Double Diode Output Pentode ...	7-pin (29)	2.25	250	250	6.0	36.0	50,000	—	9.5	4.3	7
PenA4	Output Pentode... ..	7-pin (25)	1.95	250	250	5.8	36.0	50,000	—	9.5	3.8	8
PenB4	Output Pentode... ..	7-pin (25)	2.1	250	275	14.0	72.0	22,000	—	8.5	8.8	3.5
Pen4VA	Output Pentode... ..	{ 5-pin (12) 7-pin (25) }	1.35	250	250	20.0	36.0	40,000	—	2.8	3.8	6

1 V † + g₅ = 70V.

* Numbers in brackets in "e" Column refer to the Base Diagrams.

VALVE DATA **5**
CURRENT MAINTENANCE TYPES
4 VOLT MISCELLANEOUS TYPES

Type	Description	Base*	Working Conditions					Characteristics at Working Conditions			Pout (W)	Optimum Load (kg)
			If or I _h (A)	V _a (V)	V _{g2} (V)	-V _{g1} (V)	I _a (mA)	r _a (ohms)	μ	gm or gc (mA/V)		
Pen428	Output Pentode...	7-pin (25)	2.1	375	275	Rk=165Ω	2 x 48	—	—	—	28.0***	6.5
AZ1	Full Wave Rectifier (D.H.)	P. Base (43)	1.1	2 x 300	—	—	100	—	—	—	—	—
DW2	Full Wave Rectifier (D.H.)	4-pin (1)	1.0	2 x 250	—	—	60	—	—	—	—	—
DW4/350	Full Wave Rectifier (D.H.)	4-pin (1)	2.0	2 x 350	—	—	120	—	—	—	—	—
DW4/500	Full Wave Rectifier (D.H.)	4-pin (1)	2.0	2 x 500	—	—	120	—	—	—	—	—
FW4/800	Full Wave Rectifier (D.H.)	4-pin (1)	3.0	2 x 850	—	—	125	—	—	—	—	—
IW4/350	Full Wave Rectifier (I.H.)	4-pin (7)	2.0	2 x 350	—	—	120	—	—	—	—	—
IW4/500	Full Wave Rectifier (I.H.)	4-pin (7)	2.5	2 x 500	—	—	120	—	—	—	—	—

* Numbers in brackets in "Base" Column refer to the Base Diagrams. *** Data for 2 x Pen428 in class A.B. push-pull. All ratings quoted for rectifiers are max.

5 VALVE DATA

CURRENT MAINTENANCE TYPES

4 VOLT DIRECTLY HEATED OUTPUT VALVES

Type	Description	Base*	Working Conditions					Characteristics at Working Conditions			Pout (W)	Optimum Load (ohms)
			If or Ih (A)	Va (V)	Vg2 (V)	-Vg1 (V)	Ia (mA)	ra (ohms)	μ	gm or gc (mA/V)		
ACO42	Output Triode	4-pin (3)	$\left. \begin{array}{l} 2.0V \\ 2.0A \end{array} \right\}$ 1.0	300	—	38.0	50.0	1,200	6.0	5.0	3.5	2,300
ACO44	Output Triode	4-pin (3)		300	—	38.0	50.0	1,200	6.0	5.0	3.5	2,300
DO30	Output Triode	4-pin (3)	2.0	500	—	134	60.0	**580	**4.0	**6.9	11.0	6,000
PM24A	Output Pentode	5-pin (11)	0.275	300	200	22.5	20.0	35,000	—	1.7	2.8	15,000
PM24M	Output Pentode	5-pin (11)	1.1	250	250	17.0	30.0	43,000	130	3.0	2.8	7,000

** At Va=100V, Vg

* Numbers in "use" Column refer to the Base Diagrams.

VALVE DATA **5**
CURRENT MAINTENANCE TYPES
6.3 VOLT MISCELLANEOUS TYPES

Type	Description	Base*	Working Conditions					Characteristics at Working Conditions			Optimum Load
			I _h (A)	V _a (V)	V _{g2} (V)	-V _{g1} (V)	I _a (mA)	r _a (ohms)	μ	gm or gc (mA/V)	
ECH3	Triode Hexode F.C. ...	P. Base (52)	0.2	250	100	2.0	3.0	1,300,000	—	0.65	—
EK2	Octode Frequency Changer ...	P. Base (33)	0.2	250	200††	2.0	1.0	2,000,000	—	0.55	—
EF36	R.F. Pentode ...	Octal (72)	0.2	250	100	2.0	3.0	2,500,000	4,500	1.8	—
EF9	Variable-μ R.F. Pentode ...	P. Base (47)	0.2	250	100	2.5	6.0	1,250,000	—	2.2	—
EE50	Secondary Emission Television Valve	B9G	0.3	250	250	3.0	10.0	250,000	—	14.0	—
EBC3	Double Diode Triode ...	P. Base (45)	0.2	250	—	5.5	5.0	15,000	30	2.0	—
EM1	Tuning Indicator...	P. Base (21)	0.2	250	—	0.5	0.13†	—	—	—	2MΩ
EM4	Tuning Indicator (Oval Sensitivity) ...	P. Base (51)	0.2	{ 250 250 }	—	0.16 0.5	0.75†	—	—	—	11MΩ
EBL1	Double Diode Output Pentode ...	P. Base (50)	1.2	250	250	6.0	36.0	50,000	—	9.5	4.3 7KΩ
EL2	Output Pentode ...	P. Base (48)	0.2	250	250	18.0	32.0	70,000	—	2.8	3.6 8KΩ
EL3	Output Pentode ...	P. Base (46)	0.9	250	250	6.0	36.0	50,000	—	9.0	4.5 7KΩ

††V_{g3} + g₅ = 50V
 † Load resistance each anode
 * Numbers in brackets in "Base" Column refer to the Base Diagrams
 † Target Current

5 VALVE DATA CURRENT MAINTENANCE TYPES

0.2 AMP. DC/AC MISCELLANEOUS TYPES

Type	Description	Base*	Working Conditions						Characteristics at Working Conditions			P _{out} (W)	Optimum Load (K.Ω)	
			V _h (V)	I _h (A)	V _a (V)	V _{g2} (V)	-V _{g1} (V)	I _a (mA)	r _a (ohms)	μ	gm or gc (mA/V)			
FC13	Octode Frequency Changer ...	P. Base (33)	13-0	0-2	200	90†	1-5	1-6	—	—	—	—	—	—
FC13C	Octode Frequency Changer ...	7-pin (34)	13-0	0-2	200	90†	1-5	1-6	—	—	—	—	—	—
TH21C	Triode Hexode F.C. ...	7-pin (31)	21-0	0-2	250	70	1-5	4-0	1,500,000	—	—	—	—	—
TH30C	Triode Heptode F.C. ...	7-pin (31)	29-0	0-2	250	100	2-5	3-25	1,500,000	—	—	—	—	—
VP13A	Variable-μ R.F. Pentode ...	P. Base (47)	13-0	0-2	200	100	2-18	4-0	—	2,200	—	—	—	—
VP13C	Variable-μ R.F. Pentode ...	7-pin (26)	13-0	0-2	200	200	2-34	9-0	—	—	—	—	—	—
SP13	R.F. Pentode ...	P. Base (47)	13-0	0-2	200	100	2-0	3-3	1,300,000	—	—	—	—	—
SP13C	R.F. Pentode ...	7-pin (26)	13-0	0-2	200	200	2-2	2-5	2,500,000	—	—	—	—	—
HL13	Med. Impedance Triode (M) ...	P. Base (44)	13-0	0-2	200	—	3-7	5-0	12,000	40	—	—	—	—
HL13C	Med. Impedance Triode (M) ...	7-pin (19)	13-0	0-2	200	—	3-7	5-0	12,000	40	—	—	—	—
TDD13C	Double Diode Triode ...	7-pin (20)	13-0	0-2	200	—	5-0	4-0	13,500	27	—	—	—	—
CBL1	Double Diode Output Pentode	{ P. Base (50) Octal (75) }	44-0	0-2	200	200	8-5	45-0	35,000	—	—	—	—	4-5
CL4 Pen36C	Output Pentode... ..	{ P. Base (48) 7-pin (25) }	33-0	0-2	200	200	8-5	45-0	35,000	—	—	—	—	4-5
CY1 CY31	Half Wave Rectifier (I.H.) ...	{ P. Base (42) Octal (53) }	20	0-2	250	—	—	120	—	—	—	—	—	—
UR1C	Half Wave Rectifier (I.H.) ...	5-pin (6)	20	0-2	250	—	—	75	—	—	—	—	—	—
UR3C	Multiple Rectifier (I.H.) ...	7-pin (18)	30	0-2	2 x 250	—	—	120	—	—	—	—	—	—

† Vg3 + g5 = 70V

* Numbers in brackets in "Base" column refer to the base diagrams

2 VOLT MISCELLANEOUS TYPES

Type	Description	Base	Working Conditions						Characteristics at Working Conditions			Optimum Load (ohms)
			If or I _h (A)	V _a (V)	V _{g2} (V)	-V _{g1} (V)	I _{la} (mA)	r _a (ohms)	μ	g _m or g _c (mA/V)	P _{out} (W)	
PM12A	R.F. Screened Tetrode ...	4-pin	0.18	125	75	0	1.9	330,000	500	1.5	—	
2D2	Indirectly Heated Double Diode	5-pin	0.09	125*	—	—	0.5*	—	—	—	—	
TDD2	Double Diode Triode ...	5-pin	0.1	150	—	5.5	2.5	12,000†	16.5†	1.4†	—	
PM2	Output Triode ...	4-pin	0.2	150	—	12.0	6.6	4,400†	7.5†	1.7†	9,000	
PM252	Output Triode ...	4-pin	0.4	150	—	9.0-12.0	19.0	1,900†	7.0†	3.7†	4,500	
PM2BA	Class B Output Triode ...	7-pin	0.2	120	—	4.5	3.0	—	—	2.15	14,000	
PM22	Output Pentode ...	4-pin or 5-pin	0.3	150	150	10.0	15.0	—	—	1.3†	8,000	
PM22D	High Sensitivity Output Pentode	5-pin	0.3	135	135	2.4	5.0	—	—	3.0	24,000	

† Measured at V_a = 100V V_{g1} = 0V

● Maximum rating

6 VALVE DATA OBSOLESCENT TYPES

4 VOLT MISCELLANEOUS TYPES

Type	Description	Base	Working Conditions					Characteristics at Working Conditions				Pout (W)	Optimum Load
			Ih (A)	Va (V)	Vg2 (V)	-Vg1 (V)	Is (mA)	ra (ohms)	μ	gm or gc (mA/V)			
TH4	Triode Hexode Frequency Changer	7-pin	1.0	250	70	1.5	4.0	1,500,000	—	1.0	—	—	—
TH4A	Triode Hexode Frequency Changer	7-pin	1.45	250	100	2.0	3.5	1,500,000	—	0.75	—	—	—
SD4	Diode Tetrode ...	7-pin	1.0	200	100	—	—	—	—	3.0	—	—	—
MM4V	Variable-Mu Screened Tetrode	5-pin	1.0	200	110	1.5	6.0	—	—	2.5	—	—	—
S4VA	Screened Tetrode ...	5-pin	1.0	200	110	1.5	2.75	500,000	1,000	2.0	—	—	—
S4VB	Screened Tetrode ...	5-pin	1.0	200	110	1.5	4.6	300,000	750	2.5	—	—	—
SP4C	R.F. Pentode ...	P. Base	0.65	250	250	2.0	4.5	—	—	4.0	—	—	—
VM4V	Variable-Mu Screened Tetrode	5-pin	1.0	200	100	1.5	8.5	—	—	1.2	—	—	—
164V	Medium Impedance Triode	5-pin	0.65	200	—	9.0	12.0	4,700	16	3.4	—	—	—
244V	Medium Impedance Triode	5-pin	0.65	200	—	5.5	5.5	9,000†	25†	2.8†	—	—	—
484V	Medium Impedance Triode	5-pin	1.0	200	—	3.0	2.8	21,800†	48†	2.2†	—	—	—
994V	High Impedance Triode ...	5-pin	0.65	200	—	1.5	1.35	35,000†	125†	3.6†	—	—	—
104V	Small Output Triode	5-pin	1.0	200	—	12.0	17.0	3,000†	12†	4.0†	—	—	6K Ω
AL60	Output Pentode ...	7-pin	2.1	250	250	7.0	72.0	20,000	—	14.5	—	—	3.5K Ω
Pen4V	Output Pentode ...	5-pin	1.0	250	200	10.0	35.0	—	—	3.0†	—	—	8K Ω
Pen4VB	Output Pentode ...	7-pin	1.95	250	250	5.8	36.0	50,000	—	9.5	—	—	8K Ω
IW3	Full-Wave Rectifier (I.H.) ...	4-pin	2.4	2 x 350*	—	—	120*	—	—	—	—	—	—
IW4	Full-Wave Rectifier (I.H.) ...	4-pin	2.4	2 x 500*	—	—	120*	—	—	—	—	—	—
DW3	Full-Wave Rectifier (D.H.)	4-pin	2.0	2 x 350*	—	—	120*	—	—	—	—	—	—
DW4	Full-Wave Rectifier (D.H.)	4-pin	2.0	2 x 500*	—	—	120*	—	—	—	—	—	—
AZ3	Full-Wave Rectifier (I.H.)	P. Base	2.0	2 x 350*	—	—	120*	—	—	—	—	—	—

† At Va = 100V; Vg1 = 0V.

* maximum rating.

DC/AC MISCELLANEOUS TYPES

Type	Description	Base	Working Conditions						Characteristics at Working Conditions			Pout (W)	Optimum Load (KΩ)	
			V _h (V)	I _h (A)	V _a (V)	V _{g2} (V)	-V _{g1} (V)	I _a (mA)	r _a (ohms)	μ	gm or gc (mA/V)			
2D13A	Double Diode ...	V. Base	13.0	0.2	200*	—	—	—	0.8*	—	—	—	—	—
2D13C	Double Diode ...	5-pin												
TDD13	Double Diode Triode	P. Base	13.0	0.2	200	—	5.0	4.0	13,500	27	2.0	—	—	—
CL6	Output Pentode...	P. Base	35.0	0.2	200	100	9.5	45	19,000	—	8.0	4.0	4.5	—
Pen26	Output Pentode...	P. Base	24.0	0.2	200	100	19	40	—	—	3.1	3.0	5	—
CY2	Multiple Rectifier (I.H.)	P. Base	30.0	0.2	2 × 250*	—	—	120*	—	—	—	—	—	—
UY31	Half-Wave Rectifier (I.H.)	Occal	50.0	0.1	250*	—	—	125*	—	—	—	—	—	—

4VOLT DIRECTLY HEATED OUTPUT VALVES

Type	Description	Base	Working Conditions						Characteristics at Working Conditions			Pout (W)	Optimum Load (KΩ)
			I _f (A)	V _a (V)	V _{g2} (V)	-V _{g1} (V)	I _a (mA)	r _a (ohms)	μ	gm or gc (mA/V)			
D026	Triode...	4-pin	2.0	400	—	92.0	63.0	950	3.6	3.8	7.5	3	—
PM24B	Pentode ...	5-pin	1.0	400	300	40.0	30.0	—	—	2.1†	—	8	—

* Maximum rating.

† At V_a = 100v; V_{g1} = 0v.





6 VALVE DATA OBSCULENT TYPES

6.3 VOLT MISCELLANEOUS TYPES

Type	Description	Base	Working Conditions						Characteristics at Working Conditions			Pout (W)
			Ih (A)	Va (V)	Vg2 (V)	-Vg1 (V)	Ia (mA)	ra (ohms)	μ	gm or gc (mA/V)		
EF6	R.F. Pentode ...	P. Base	0.2	250	100	2	3	2,500,000	—	1.8	—	
EF8	Low Noise R.F. Hexode ...	P. Base	0.2	250	250	2.5†	8	450,000	—	1.8	—	
EK3	Octode Frequency Changer ...	P. Base	0.6	250	100	2.5	2.5	2,000,000	—	0.65	—	
EB4	Double Diode ...	P. Base	0.2	200*	—	—	0.8*	—	—	—	—	
EAB1	Triple Diode ...	P. Base	0.2	200*	—	—	0.8*	—	—	—	—	

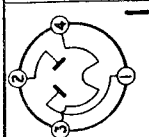
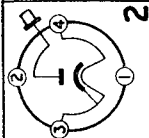
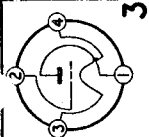
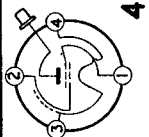
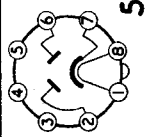
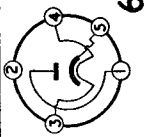
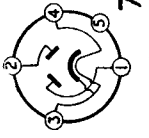
† g2 and g4 connected to cathode.

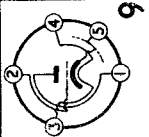
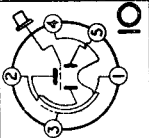
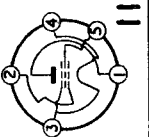
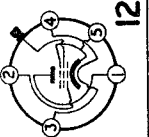
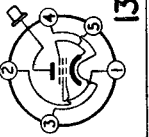
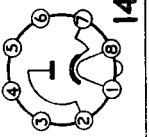
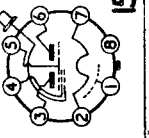

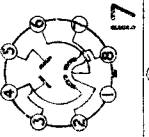
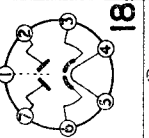
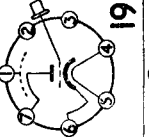
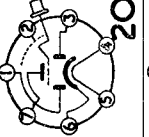
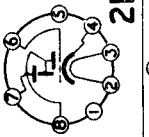
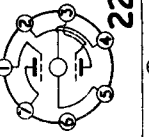
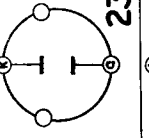
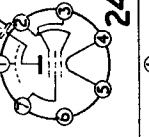
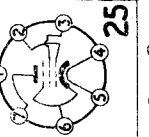
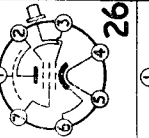
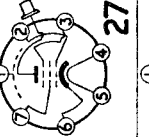
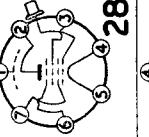
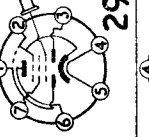
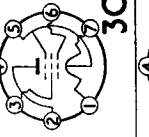
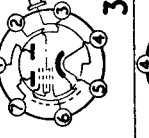
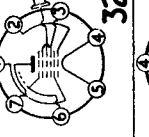
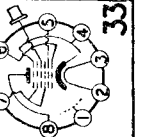
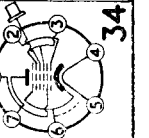
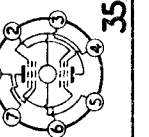
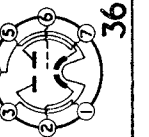
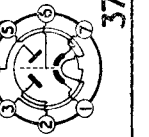
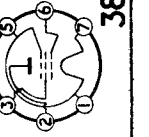
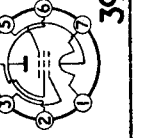
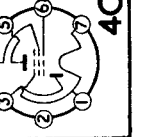
* Maximum rating.

 1	 2	 3	 4	 5	 6	 7	 8
 9	 10	 11	 12	 13	 14	 15	 16
 17	 18	 19	 20	 21	 22	 23	 24
 25	 26	 27	 28	 29	 30	 31	 32
 33	 34	 35	 36	 37	 38	 39	 40

7 VALVE DATA

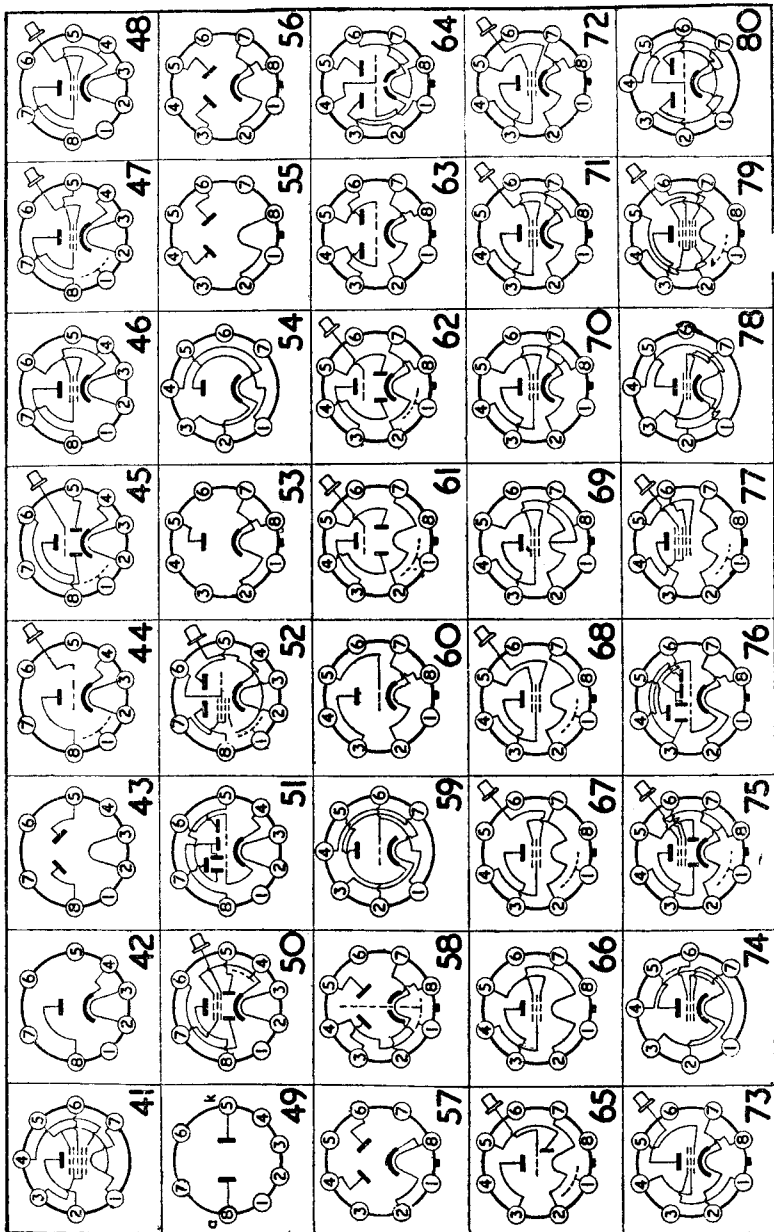
VALVE BASES

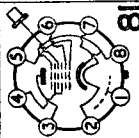
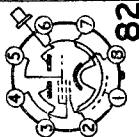
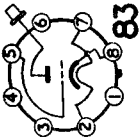
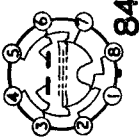
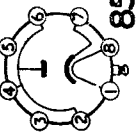
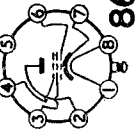
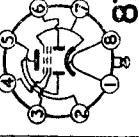
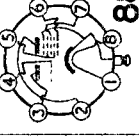
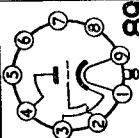
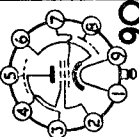
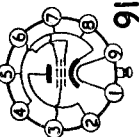
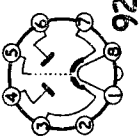
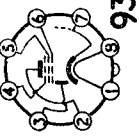
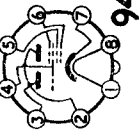
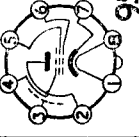
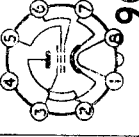
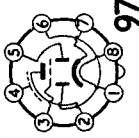
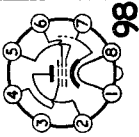
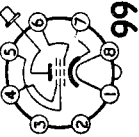
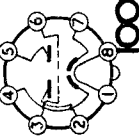

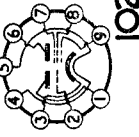
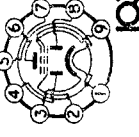
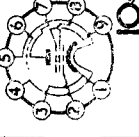
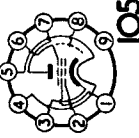
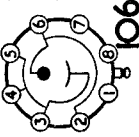
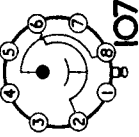
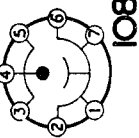
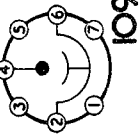
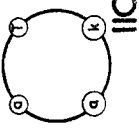
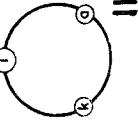
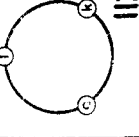
 81	 82	 83	 84	 85	 86	 87	 88
 89	 90	 91	 92	 93	 94	 95	 96
 97	 98	 99	 100	 101	 102	 103	 104
 105	 106	 107	 108	 109	 110	 111	 112

7 VALVE DATA

VALVE BASES

<p>113</p>	<p>114</p>	<p>115</p>	<p>116</p>	<p>117</p>	<p>118</p>	<p>119</p>	<p>120</p>
<p>NOTE In bases Nos 115 and 116 pins marked 'X' are connected internally and must not be used for external bonded connections.</p>			<p>121</p> <p>Red spot indicates the anode lead</p>	<p>METALLISING</p> <p>TOP CAP</p> <p>SIDE TERMINAL</p> <p>SCREEN</p>			
<p>BRITISH 4 PIN (A BASE)</p>	<p>BRITISH 5 PIN (O BASE)</p>	<p>BRITISH 7 PIN (M BASE)</p>	<p>SIDE CONTACT (P BASE)</p>	<p>NOVAL (B9A)</p>	<p>8 PIN MINIATURE (B8A)</p>	<p>9 PIN ALL GLASS (B9G)</p>	<p>LOCTAL (B8G)</p>
<p>DUODECAL (B12A)</p>	<p>SIDE CONTACT (V BASE)</p>	<p>OCTAL (K BASE)</p>	<p>7 PIN MINIATURE (B7G)</p>	<p>9 PIN ALL GLASS (B9G)</p>	<p>8 PIN MINIATURE (B8A)</p>	<p>LOCTAL (B8G)</p>	<p>9 PIN ALL GLASS (B9G)</p>

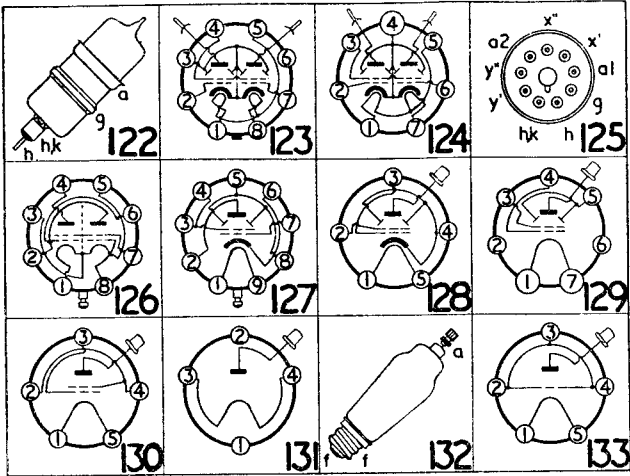

DIRECT EQUIVALENTS A

Type	Mullard Equiv. or Manufacturer	Type	Mullard Equiv. or Manufacturer
A			
A11D	IW4-350	C36C	TH30C
A20B	2D4A	C50B	SP13C
A23A	TDD4	C50N	VP13C
A27D	PEN4DD	C70D	PEN36C
A30B	E/Ready	C80B	FC13C
A30D	354V	CB215	PM2B
A36C	TH4B	CBL1	CBL1
A50A	SP4	CBL31	CBL31
A50B	SP4B	CCH35	CCH35
A50M	VP4.7	CL4	CL4
A50N	VP4A.(7)	CL33	CL33
A50P	VP4B	CY1	CY1
A70B	PEN4VA(7)	CY1C	UR1C
A70D	PENA4	CY31	CY31
A70E	PENB4		
A80A	FC4	D	
AC/HL	354V	D1	Mazda
AC/HL/DD	TDD4	D4	354V
ACO42	ACO42	D41	2D4A
ACO44	ACO44	D42	Osram
AC/P	TT4	D43	Osram
AC/P4	Mazda	D63	EB34*
AC/PEN	PEN4VA	D77	EB91
AC/SG	Mazda	DA	Ferranti
AC/SG/VM	Mazda	DA30	DO30
AC/TH1	TH4B	DA90	DA90
AC/TP	Mazda	DAC32	DAC32
AC/VP1	Mazda	DAF91	DAF91
AC/VP2	VP4B	DCC90	DCC90
AC2/HL	Mazda	DD4	2D4A
AC2/PEN	PENA4	DD6	EB91
AC2/PENDD	Mazda	DD41	Mazda
AC4/PEN	PENB4	DDL4	Cossor
AC5/PEN	Mazda	DDPP4M	PEN4DD
AC5/PENDD	Mazda	DDT	Cossor
APP4A	PEN4VA	DDT2	TDD2A
APP4B	PENA4	DDT4	TDD4
APP4E	PENB4	DDT13	TDD13C
APV4	IW4-350	DF33	DF33
AZ1	AZ1	DF66	DF66
AZ31	AZ31	DF70	DF70
		DF91	DF91
B		DF92	DF92
B36	Osram	DH63	Osram
B65	Osram	DH76	Osram
		DH77	Osram
C		DH81	Osram
C10B	UR1C	DH101	Osram
C20C	E/Ready	DH107	Osram
C23B	TDD13C	HL142	Osram
C30B	HL13C	DH147	UBC41
C36A	TH21C		EBC33

* Valve having different heater current, not direct replacement in AC/DC Receivers



DIRECT EQUIVALENTS A

Type	Mullard Equiv. or Manufacturer	Type	Mullard Equiv. or Manufacturer
G			
GDT4B	Cossor	K70D	PM22D
GDT4C	Cossor	K77B	QP22B
GU50	RG1-240A	K80A	FC2
GZ32	GZ32	K80B	FC2A
		KBC32	KBC32
		KCF30	KCF30
		KF35	KF35
H		KK32	KK32
H2D	TDD2A	KL35	KL35
44D	Ferranti	KLL32	KLL32
H63	Osram	KT2	PM22A
HAD	Ferranti	KT24	PM22A
HD14	DAC32	KT32	Osram
HD24	TDD2A	KT33c	Osram
HL2	PM ² HL	KT36	Osram
HL13 (Tung.)	HL13C	KT41	Osram
HL13 (Mull.)	HL13	KT44	Osram
HL13s	HL13	KT45	Osram
HL13C	HL13C	KT61	Osram
HL23	Mazda	KT63	Osram
HL23DD	Mazda	KT66	EL37
HL41	Mazda	KT71	Osram
HL41/DD	Mazda	KT76	Osram
HL42/DD	Mazda	KT81	Osram
HL/133/DD	Mazda	KT101	Osram
HLA2	345V	KTW61	Osram
HP2	PM2B	KTW63	Osram
HP13s	VP13A	KTZ41	Osram
HP210nc	SP2	KTZ63	Osram
HP211c	VP2		EF37*
HP4101c	SP4		
HP4115c	VP4A	L	
HR1	Ferranti	L2	PM2A
HR2	Ferranti	L4	TT4
HR3	Ferranti	L63	Osram
HR4	Ferranti	L77	Osram
HSD	Ferranti	LP2	Ferranti
HVR2	HVR2	LP2 (M.O.)	PM2A
		LP4	ACO44
		LP220	PM2A
I			
IW4-350	IW4-350		
IW4-500	IW4-500	M	
		ME6s	EM1
K		ME41	Mazda
K23B	TDD2A	ME91	Mazda
K30G	PM2A	MH4	354V
K30K	PM2HL	MH41	Marconi
K33A	PM2B	MHD4	Osram
K40N	PM12M	MHL4	Osram
K50M	VP2	MKT4	Osram
K50N	VP2B	ML4	PEN4VA
K70B	PM22A	MP/PEN	TT4
			PEN4VA

* Valve having different heater current, not direct replacement in AC/DC Receivers



8 VALVE DATA

A DIRECT EQUIVALENTS

Type	Mullard Equiv. or Manufacturer	Type	Mullard Equiv. or Manufacturer
MS4B	Osram	PEN45DD	Mazda
MSP4	SP4	PEN46	Mazda
MSP41	Osram	PEN220	PM22A
MS/PEN	SP4	PEN383	Mazda
MS/PENB	Cossor	PEN384	Mazda
MU14	IW4-500	PEN428	PEN428
MVS/PEN	VP4A	PEN453DD	Mazda
MVS/PENB	Cossor	PENA4	PENA4
MX40	Osram	PENB4	PENB4
		PENDD4020	Mazda
N		PL33	PL33
N1	Osram	PL38	PL38
N2	Osram	PL38M	PL38M
N14	DL35	PL81	PL81
N16	DL33	PL82	PL82
N17	DL92	PL83	PL83
N19	DL94	PM2A	PM2A
N77	EL91	PM2B	PM2B
N78	Osram	PM2HL	PM2HL
N108	Osram	PM12M	PM12M
N142	UL41	PM22A	PM22A
N144	EL91	PM22D	PM22D
N145	Osram	PM24A	PM24A
N147	EL33	PM24M	PM24M
N150	EL41	PM202	PM202
N151	EL42	PP2	PM22A
		PP3/250	ACO44
O		PP4	PM24M
OM1	CY31	PP5/400	Mazda
OM4	EBC33	PP35	PEN36C
OM5A	EF37	PT2	PM22A
OM5B	EF37A	PT4	PENA4
OM6	EF39	PT4D	Ferranti
OM7	EF39	PT10	Cossor
OM9	EL32	PT25H	Osram
OM10	CCH35	PT41	PM24M
OZ4	Ferranti/Brimar	PTA	Ferranti
		PTS	Ferranti
P		PTSD	Ferranti
P2	PM202	PTZ	Ferranti
P12/250	ACO44	PV30	UR3C
P41	Mazda	PX4	ACO44
P61	Mazda	PX25	Osram
PA1	Brimar	PY31	PY31
PA20	ACO42	PZ30	PZ30
PEN4DD	PEN4DD		
PEN4VA	PEN4VA	Q	
PEN25	Mazda	QP21	Osram
PEN36C	PEN36C	QP25	Mazda
PEN44	Mazda	QP22B	QP22B
PEN45	Mazda	QP230	QP22B
		QPT2	Ferranti



DIRECT EQUIVALENTS A

Type	Mullard Equiv. or Manufacturer	Type	Mullard Equiv. or Manufacturer
R			
R1	DW2	TH21C	TH21C
R2	IW4-350	TH29	TH30C
R3	IW4-500	TH30	TH30C
R4	DW4-350	TH30C	TH30C
R4A	DW4-500	TH41	Mazda
R10	Brimar	TH233	Mazda
R12	Brimar	TH2321	TH30C
R42	IW4-350	TP22	Mazda
R52	GZ32	TP23	Mazda
RV120/350	DW4-350	TP25	Mazda
RV120/500	DW4-500	TP2620	Mazda
RV200/600	FW4-800	TSE4	TSE4
RZ	UR1C	TSP4	TSP4
		TT4	TT4
		TX21	TH21C
S		U	
S2	Ferranti	U10	DW2
S11A	DW2	U14	DW4-500
S11D	DW4-350	U16	Osram
S30C	ACO44	U17	Osram
S30D	ACO42	U18/20	FW4-500
SD	Ferranti	U19/23	Osram
SD6	Cossor	U21	Mazda
SE211c	PM12M	U22	Mazda
SP2	SP2	U24	Mazda
SP4	SP4	U31	PY31
SP4B	SP4B	U33	Osram
SP6	EF91	U35	Osram
SP13	SP13	U37	Osram
SP13B	SP13C	U50	Osram
SP13C	SP13C	U52	Osram
SP13s	SP13	U70	Osram
SP41	Mazda	U76	EZ35
SP42	Mazda	U78	Osram
SP61	Mazda	U82	Osram
SP181	Mazda	U84	Osram
SP220	PM202	U101	Osram
SPT2	SP2	U107	Osram
jPT4A	SP4	U142	UY41
SU25	Cossor	U143	AZ31
SU61	EY51	U145	UY41
SU2150	Cossor	U147	EZ35
SU2150A	Cossor	U149	Osram
T		U150	EZ40
T4D	T4D	U201	CY31
T41	Mazda	U281	Mazda
TDD2A	TDD2A	U403	Mazda
TDD4	TDD4	U404	UY41
TDD13C	TDD13C	U801	Mazda
TH4B	TH4B	U4020	UR1C



8 VALVE DATA

A DIRECT EQUIVALENTS

Type	Mullard Equiv. or Manufacturer	Type	Mullard Equiv. or Manufacturer
UAF42	UAF42	VP133	Mazda
UB41	UB41	VP210	Mazda
UBC41	UBC41	VP132Z	VP13C
UBF80	UBF80	VPT2	Ferranti
UBL21	UBL21	VPT4	VP4
UCH21	UCH21	VPT4B	VP4A
UCH42	UCH42	VPTA	Ferranti
UF41	UF41	VPTS	Ferranti
UF42	UF42	VS2	PM12M
UL41	UL41	VX2	VP2B
UL44	UL44		
UL46	UL46		
UM34	UM34	W	
UR1C	UR1C	W17	DF91
UR3C	UR3C	W21	Osram
UU5	IW4-500	W42	Osram
UU6	Mazda	W61	Osram
UU7	Mazda	W76	Osram
UU8	Mazda	W77	EF92
UU9	EZ40	W81	Osram
UU10	Mazda	W101	Osram
UY21	Mazda	W107	Osram
UY41	UY41	W143	EF22
		W145	Osram
V		W147	EF39
V20	UR1C	W148	Osram
V312	Mazda	W149	Osram
V503	Mazda	W150	EF41
V914	2D4A	WD142	UAF42
VHTA	Ferranti	WD150	EAF42
VHT2A	FC2A		
VHT4	FC4	X	
VHTS	Ferranti	X14	DK32
VMP4G	Osram	X17	DK91
VMS4B	Osram	X22	FC2
VO2	FC2A	X24	Osram
VO4	FC4	X41	Osram
VO13	FC13C	X61M	ECH35
VO13s	FC13	X63	Osram
VP2	VP2	X65	Osram
VP2B	VP2B	X76M	Osram
VP4	VP4	X78	Osram
VP4A	VP4A	X81	Osram
VP4B	VP4B	X101	Osram
VP6	EF92	X108	Osram
VP12D	Ferranti	X142	UCH42
VP13A	VP13A	X143	ECH21
VP13B	VP13C	X145	Osram
VP13C	VP13C	X147	ECH35
VP23	Mazda	X148	Osram
VP41	Mazda	X150	ECH42



DIRECT EQUIVALENTS A

Type	Mullard Equiv. or Manufacturer	Type	Mullard Equiv. or Manufacturer
Y			
Y61	Osram	3A4	DL93
Y62	Osram	3D6	Brimar
Y63	Osram	3Q5G	DL33
Y64	Osram	3Q5GT	DL33
Y65	Osram	3S4	DL92
		3V4	DL94
		4D1	Brimar
		4THA	Cossor
Z		4TPB	Cossor
Z14	DF33	4TSA	Cossor
Z21	Osram	4TSP	Cossor
Z22	SP2	4XP	ACO44
Z63	Osram		
Z66	Osram	5U4G	5U4G
Z77	EF91	5V4G	GZ32
Z142	UF42	5Y3G	5Y3G
Z150	EF42	5Y3GT	Brimar
ZD	Ferranti	5Z4	Ferranti
ZD17	DAF91	5Z4G	GZ32
1A5GT	Ferranti/Brimar	6A7	Brimar
1A7G	Brimar	6A8G	6A8G
1A7GT/G	DK32	6A8GT	Brimar
1C1	DK91	6AB7	Ferranti
1C5G	DL35	6AC7	Ferranti
1C5GT/G	DL35	6AG6G	EL33
1D5	Brimar	6AL5	EB91
1D6	Brimar	6AM5	EL91
1F2	DF92	6AM6	EF91
1F3	DF91	6AQ5	Brimar
1FD9	DAF91	6AT6	Brimar
1H5G	Brimar	6AU6	Brimar
1H5GT/G	DAC32		
1L4	Brimar	6B7	Ferranti
1LA4E	Brimar	6B8	Ferranti
1LA6E	Brimar	6B8G	Ferranti/Brimar
1LD5	Brimar	6BA6	Brimar
1LH4	Brimar	6BE6	Brimar
1LN5E	Brimar	6BG6G	Brimar
1N5G	Brimar		
1N5GT/G	DF33	6C4	Brimar
1P10	DL92	6C5	Ferranti
1P11	DL94	6C5G	6C5G
1Q5GT	Ferranti	6C5GT/G	Ferranti
1R5	DK91	6C6	Ferranti/Brimar
1S4	Ferranti/Brimar	6C9	Mazda
1S5	DAF91	6C31	Mazda
1T4	DF91	6D1	EA50
2D4A	2D4A	6D2	EB91
2P	Cossor	6D6	Ferranti/ Brimar



8 VALVE DATA

A DIRECT EQUIVALENTS

Type	Mullard Equiv. or Manufacturer	Type	Mullard Equiv. or Manufacturer
6E8G	ECH35	6SG7	Ferranti
6F1	Mazda	6SH7	Ferranti
6F6	Ferranti	6SJ7	Ferranti
6F6G	6F6G	6SJ7GT	Ferranti
6F8G	Ferranti	6SK7	Ferranti
6F11	Mazda	6SK7GT	Ferranti
6F12	EF91	6SL7GT	ECC35*
6F13	Mazda	6SN7GT	Ferranti/Brimar
6F14	Mazda	6SQ7	Ferranti
6F15	Mazda	6SQ7GT	Ferranti
6F16	EF41	6SS7	Ferranti
6G6G	Ferranti	6U5/6G5	Brimar
6H6	Ferranti	6U5G	Brimar
6H6G	Ferranti/Brimar	6U7G	Ferranti/Brimar
6H6GT	Ferranti	6V6	Ferranti
6J5	Ferranti	6V6G	6V6G
6J5G	Cossor/Tun./ Brimar/Ferranti	6V6GT	Ferranti/Brimar
6J5GT	Ferranti/Brimar	6X4	Brimar
6J6	ECC91	6X5G	6X5G/EZ35
6J7	Ferranti	6X5GT	EZ35
6J7G	6J7G	6Y6G	Ferranti
6J7GT	EF37*	7A2	PEN4VA
6K6GT/G	Ferranti	7A3	PENA4
6K7	Ferranti	7B6	Brimar
6K7G	6K7G	7B7	Cossor/Brimar
6K7GT	EF39*	7C5	Cossor/Ferranti/ Brimar
6K8G	6K8G	7C6	Cossor
6K8GT	Ferranti/Brimar	7D3	Brimar
6K25	Mazda	7D5	Brimar
6L6	Ferranti	7D6	PEN36C
6L6G	6L6G	7D8	Brimar
6L18	Mazda	7H7	Cossor/Ferranti/ Brimar
6L19	Mazda	7K7	Ferranti/Brimar
6LD20	Mazda	7Q7	Ferranti
6M1	Mazda	7R7	Cossor
6N7	Ferranti	7S7	Brimar
6N7GT	Ferranti/Brimar		
6P25	Mazda		
6P28	Mazda		
6Q7G	6Q7G		
6Q7GT	Ferranti/Brimar		
6R7G	Ferranti/Brimar		
6SA7	Ferranti		

* Valve having different heater current, not direct replacement in AC/DC Receivers



DIRECT EQUIVALENTS A

Type	Mullard Equiv. or Manufacturer	Type	Mullard Equiv. or Manufacturer
7Y4	Ferranti/Brimar Cossor Brimar/Ferranti	15A2	Brimar
7Z4		15D1	Brimar
8A1	SP4	18	Brimar
8D2	Brimar	19B6G	Brimar
8D3	EF91		
9A1	VP4	20A1	TH4B
9D2	Brimar	20D1	Mazda
9D6	EF92	20D2	Brimar
10C1	Mazda	20F2	Mazda
10D1		Brimar	20P1
10F1	Mazda	25A6G	25A6G
10F3	Mazda	25L6G	Ferranti
10F9	UF41	25L6GT	Brimar
10LD11	Mazda	25Z4G	Brimar
10P13	Mazda	27SU	Cossor
10P14	UL41	35A5	Cossor
11A2	Brimar	35L6GT/G	Ferranti/Brimar
11D3	Brimar	35Z3	Cossor
11D5	Brimar	35Z4GT	Ferranti/Brimar
12A6	Ferranti/Brimar	40SUA	Cossor
12AH7	Ferranti	41FP	Cossor
12AT7	Brimar	41MH	Cossor
12AU7	Brimar	41MHL	354V
12AX7	Brimar	41MP	TT4
12C8	Ferranti	41MPG	FC4
12C8GT	Brimar	41MPT	Cossor
12J7GT	Ferranti/Brimar	41MTL	Cossor
12K7GT	Ferranti/Brimar	41MXP	Cossor
12K8	Ferranti	41STH	Cossor
12K8GT	Ferranti/Brimar	42	Ferranti/Brimar
12Q7GT	Ferranti/Brimar	42MP/PEN	PENA4
12SJ7	Ferranti	42MPT	Cossor
12SJ7GT	Ferranti	42/OT	PENA4
12SK7	Ferranti/Brimar	42/OTDD	Cossor
12SK7GT	Ferranti	42SPT	Cossor
12SQ7	Ferranti	43	Brimar
12SQ7GT	Ferranti	43IU	IW4-350
12SR7	Ferranti	45IU	Cossor
13SPA	Cossor	50L6G	Ferranti
13VPA	Cossor	50L6GT	Brimar
14H7	Brimar	52KU	Cossor
14S7	Cossor/Brimar	53KU	Cossor
		54KU	GZ32
		61BT	Cossor
		61SPT	Cossor
		62BT	Cossor



8 VALVE DATA

A DIRECT EQUIVALENTS

Type	Mullard Equiv. or Manufacturer	Type	Mullard Equiv. or Manufacturer
63ME	Cossor	215SG	PM12M
63SPT	EF50	220OT	PM22A
64ME	EM34	220P	Cossor
75	Brimar	220PA	PM2A
77	Brimar/Ferranti	220PT	Cossor
78	Brimar/Ferranti	220TH	Cossor
80	Brimar/Ferranti	225DU	Cossor
142BT	Cossor	230XP	Cossor
185BT	Cossor	240QP	QP22B
202DDT	TDD13C	302THA	TH30C
202STH	TH21C	332PEN	CL33
202VP	Cossor	354V	354V
202VPB	Cossor	402P	Cossor
203THA	Cossor	402/PEN	Cossor
210DDT	Cossor	402/PENA	Cossor
210HF	TDD2A	405BU	Cossor
210HL	PM2HL	506BU	DW2
210HL	PM2HL	1561	DW4-500
210LF	Cossor	1629	Brimar
210PG	FC2	1821	DW2
210SPT	Cossor	1867	IW4-350
210VPA	Cossor	1881	IW4-350
210VPT	Cossor		
215P	Cossor		



AMERICAN—MULLARD				
American Type	Base	Mullard Type	Base	Conversion
1A4P	UX	KF35	K	Change base.
1A6	UX	KK32	K	Change base.
1A7G	K	DK32	K	Earth pin 1.
1C6	UX	KK32	K	Change base.
1C7G	K	KK32	K	Earth pin 1.
1D7G	K	KK32	K	Earth pin 1.
1E5G	K	KF35	K	Earth pins 1 and 5.
1F4	UX	KL35	K	Change base.
1H5G	K	DAC32	K	Earth pin 1.
1H6G	K	KBC32	K	Rewire base.
1N5G	K	DF33	K	Earth pin 1.
1Q5GT	K	DL35	K	Bias may require adjustment.
5Y3G	K	GZ32	K	GZ32 is indirectly heated.
5Y4G	K	GZ32	K	Rewire base. GZ32 is indirectly heated.
6AK6	B7G	EL91	B7G	Rewire base.
6C6	UX	EF37*	K	Change base.
6D6	UX	EF39*	K	Change base.
6J7G	K	EF37*	K	Earth pin 1.
6J8G	K	ECH35	K	Earth pin 1. Bias may require adjustment.
6K8G	K	ECH35	K	Earth pin 1. Receiver may require realigning.
6K8GT	K	ECH35	K	Receiver may require realigning.
6L6G	K	EL37	K	Bias may require adjustment.
6N7GT/G	K	ECC33	K	Rewire base. ECC33 unsuitable for use as class B output valve.
6Q7G	K	EBC33*	K	Earth pin 1. Bias may require adjustment.
6SC7	K	ECC35*	K	Rewire base.
6SN7GT	K	ECC33	K	Bias may require adjustment.
6U5/6G5	UX	EM34*	K	Change Base. Supply second anode from H.T.+ through 1 Mohm resistor.

8 VALVE DATA

B NEAR EQUIVALENTS

AMERICAN—MULLARD— <i>continued</i>				
American Type	Base	Mullard Type	Base	Conversion
6U7G	K	EF39*	K	Earth pin 1.
6V6G	K	EL33	K	Bias may require adjustment.
6W7G	K	EF37*	K	Earth pin 1.
7A7 7B7	B8G B8G	} EF22*	B8G	Bias may require adjustment.
7C5	B8G		EL41	B8A
7S7	B8G	ECH21*	B8G	Rewire base. Receiver may require realigning.
7Y4	B8G	EZ35	K	Change base.
36	UX	EF37*	K	Change base.
39/44	UX	EF39*	K	Change base.
42	UX	EL32	K	Change base.
77	UX	EF37*	K	Change base.
78	UX	EF39*	K	Change base.
80	UX	GZ32	K	Change base.
84/6Z4	UX	EZ35	K	Change base.

BRIMAR—MULLARD				
Brimar Type	Base	Mullard Type	Base	Conversion
HLB1	A	PM2HL	A	Bias may require adjustment.
1D5	O	UR1C	O	Check $I_h = 0.2$ A.
4D1	M	HL13C	M	Earth pin 1.
8D2	M	SP13C	M	Increase V_{g2} to V_a .
9D2	M	VP13C	M	Earth pin 1. Raise V_{g2} to 200 V.
11A2	M	TDD4	M	Earth pin 2. Bias may require adjustment.
15A2	M	FC4	M	V_{g2} max. = 90 V.

BRIMAR—MULLARD (Continued)				
Brimar Type	Base	Mullard Type	Base	Conversion
15D1	M	FC13C	M	Vg2 max.=90 V.
42E	UX	EL32	K	Change base.
77E	UX	EF37*	K	Change base.
78E	UX	EF39*	K	Change base.
2101	UX	KL35	K	Change base.
2102	UX	KBC32	K	Change base.

For additional types see American Substitution List.

COSSOR—MULLARD				
Cossor Type	Base	Mullard Type	Base	Conversion
DDT	M	TDD4	M	Bias may require adjustment.
MV/SG	O	VP4	O/M	Bias may require adjustment.
MVS/PenB	M	VP4B	M	Raise Vg2 to Va.
4THA	M	TH4B	M	Receiver may require realigning.
13PGA	M	FC13C	M	Vg2 max.=90 V.
13SPA	M	SP13C	M	Increase Vg2 to Va.
13VPA	M	VP13C	M	Increase Vg2 to Va.
40SUA	O	UR1C	O	Check I _h =0.2 A.
41STH	M	TH4B	M	Bias may require adjustment.
45IU	A	FW4/500	A	FW4/500 is directly heated.
210LF	A	PM2HL	A	Bias may require adjustment.
210SPT	M	SP2	M	Increase Vg2 to Va.
210VPT	M	VP2	M	Increase Vg2 to Va.
215P	A	PM2A	A	Increase Vg1 to -6V.
220P	A	PM2A	A	Bias will require adjustment.
230XP	A	PM202	A	Bias may require adjustment.

8 VALVE DATA

B NEAR EQUIVALENTS

FERRANTI—MULLARD				
Ferranti Type	Base	Mullard Type	Base	Conversion
DA	M	HL13C	M	Bias may require adjustment.
HAD	M	TDD13C	M	Bias may require adjustment.
H4D	M	TDD4	M	Bias may require adjustment.
PTZ	M	Pen36C	M	Connect g1 to T.C.
PT4D	M	Pen4DD	M	Rewire base.
QPT2	M	QP22B	M	Bias may require adjustment.
VHTA	M	FC13C	M	Vg2 max. = 90V. Receiver may require realigning.
VPT2	M	VP2	M	Increase Vg2 to Va.

HIVAC—MULLARD				
Hivac Type	Base	Mullard Type	Base	Conversion
AC/Q	M	{ PenB4 Pen428 }	M	Bias may require adjustment.
AC/Qa	K		K	Bias may require adjustment.
AC/SH	M	SP4	M	Bias may require adjustment..
AC/VH	O	VP4	O	Bias may require adjustment.
AC/Y	O/M	Pen4VA	O/M	Bias may require adjustment.
DDT215	O	TDD2A	O	Bias may require adjustment.
HL13	M	HL13C	M	Shunt heater with 130 ohm 2 W resistor.
HP215	M	SP2	M	Raise Vg2 to Va.
P215	A	PM2A	A	Bias may require adjustment.
QP240	M	QP22B	M	Bias may require adjustment.
VP13	M	VP13A	P	Change base.
VP215	M	VP2	M	Increase Vg2 to Va.
Y220	O	PM22A	O	Bias may require adjustment.

MAZDA—MULLARD				
Mazda Type	Base	Mullard Type	Base	Conversion
AC/SG	O/M	SP4	O/M	Raise Vg2. Vg2=100V for R.F. amplifier.
AC/SGVM	O/M	VP4	O/M	Raise Vg2. Vg2=100V for R.F. amplifier.
AC/S2Pen	M	SP4	M	Bias may require adjustment.
AC/VP1	M	VP4B	M	Rewire base.
AC2/PenDD	M	Pen4DD	M	Rewire base.
DD620	O	EB34	K	Change base.
HL/DD1320	M	TDD13C	M	Bias may require adjustment.
HL22	MO	PM2HL	A	Change base.
HL23DD	MO	KBC32	K	Change base.
HL41	MO	354V	O	Change base.
HL41DD	MO	TDD4	M	Change base.
HL133DD	MO	TDD13C	M	Change base.
Pen24	MO	KL35	K	Change base. Increase bias voltage to -4.5 V.
Pen25	MO	KL35	K	Change base.
PenDD4020	M	CB631	K	Change base.
QP240	9-pin	QP22B	M	Change base.
SP22	MO	SP2	M	Change base.
SP215	M	SP2	M	Bias may require adjustment.
TH41	MO	TH4B	M	Change base. Receiver may require realigning.
TH233	MO	TH30C	M	Change base. Receiver may require realigning.
TH2320	M	CCH35	K	Change base. Check I _h =0.2 A. Receiver may require realigning.
UU6	MO	IW4/350	A	Change base.
U403	MO	CY31	K	Change base. Check I _h =0.2 A.
U4020	O	UR1C	O	Check I _h =0.2 A.
VP22	MO	KF35	K	Change base.

MAZDA — MULLARD (continued)

Mazda Type	Base	Mullard Type	Base	Conversion
VP41	MO	VP4B	M	Change base.
VP133	MO	VP13C	M	Change base. Bias may require adjustment.
VP215	M	VP2	M	Increase Vg2 to Va.
VP1321	M	VP13C	M	Rewire base.
6P28	K	EL38	K	Rewire base.

MARCONI/OSRAM—MULLARD

Marconi/Osram Type	Base	Mullard Type	Base	Conversion
B21	M	PM2B	M	Reduce bias to zero.
DH63	K	EBC33*	K	Earth pin 1.
DN41	M	Pen4DD	M	Rewire base. Raise Vg2 to Va. Increase Rk to 140 ohms.
KTW61	K	EF39*	K	Earth pin 1. Bias may require adjustment.
KTW61M	K	EF39*	K	Bias may require adjustment.
KTW63	K	EF39*	K	Earth pin 1.
KTZ63	K	EF37*	K	Connect pin 5 to pin 8.
KT41	M	PenA4	M	Bias may require adjustment.
KT61	K	EL33	K	Bias may require adjustment.
KT63	K	EL32	K	Rewire base.
MHD4	M	TDD4	M	Bias may require adjustment.
MHL4	O	354V	O	Bias may require adjustment.
N15	K	DL33	K	Increase bias.
N40	O	Pen4VA	O/M	Bias may require adjustment.
QP21	M	QP22B	M	Bias may require adjustment.
U50	K	GZ32	K	GZ32 has indirectly heated cathode.

MARCONI/OSRAM—MULLARD (Continued)

Marconi/Osram Type	Base	Mullard Type	Base	Conversion
U82	B8G	EZ35	K	Change base.
U84	B8G	AZ31	A	Change base.
U101	B8G	UY21	B8G	Join pins 2, 4 and 6 together.
U149	B8G	EZ35	K	Change base.
VMP4G	M	VP4A	M	Bias may require adjustment.
W21	M	VP2	M	Join pins 3 and 4 together.
W42	M	VP4A	O/M	Change base connections.
X42	M	FC4	M	Bias may require adjustment.
X65	K	ECH35	K	Earth pin 1. Receiver may require realigning.
Y61 } Y62 } Y63 }	K	EM34*	K	Supply a" (pin 6) from H.T.+ through 1 Mohm resistor. Interchange connections to pins 4 and 5.
Z21	M	SP2	M	Earth pin 3.

TUNGSRAM—MULLARD

Tungsrham Type	Base	Mullard Type	Base	Conversion
APP4As	P	Pen4VA	O/M	Change base.
APP4Bs	P	PenA4	M	Change base.
DDPP4B	M	Pen4DD	M	Rewire base.
DDPP39M	M	CBL31	K	Change base.
DDT4s	P	TDD4	M	Change base.
DDT13s	P	TDD13C	M	Change base.
DD6ds	P	EB34	K	Change base.
DD13 } DD13s }	O } V }	EB34	K	Change base. When rewiring connect together cathodes of EB34. Vh=6.3V.
DD465	O			
LD210	A	PM2HL	A	Bias may require adjustment.
PP2s	P	PM22A	O	Change base.

8 VALVE DATA

B NEAR EQUIVALENTS

TUNGSRAM — MULLARD—(Continued)					
Tungsrasm Type	Base	Mullard Type	Base	Conversion	
PP4s	P	PM24M	O	Change base.	
PP34	M	Pen36C	M	Connect g1 to T.C.	
PP34s	P	CL33	K	Change base.	
PP36	M	Pen36C	M	Rewire base.	
PVA6s	P	EZ35	K	Change base. Check lh when series heated.	
PV29s	P	} UR3C	M	Change base.	
PV30s	P		} ACO44	A	Change base.
P12/250s	P				
P220	A	PM202	A	Bias may require adjustment.	
RV120/350s	P	AZ31	K	Change base.	
RV120/500s	P	DW4/500	A	Change base.	
SP6s	P	EF37	K	Change base.	
TX4	M	TH4B	M	Change bias resistance to 140 ohms. Grid leak to be increased to 50,000 ohms between grid and cathode.	
VO2s	P	FC2A	M	Change base.	
VX2s	P	VP2B	M	Change base.	

TRIOTRON—MULLARD				
Triotron Type	Base	Mullard Type	Base	Conversion
D1300	P	EB34	K	Change base. When rewiring connect together cathodes of EB34.
DP4480	M	CBL31	K	Vh=6.3 V. Change base.
S1324	M	SP13C	M	Raise Vg2 to Va.
YD2	A	PM2A	A	Bias may require adjustment.

- NOTES :**
- Types marked with asterisk (*) are replacements in A.C. receivers only. In AC/DC receivers it will be necessary to shunt the heater of the replacement valve, as the heater current of this valve differs from that of the original type.
 - The data provided on this chart assumes that the valve to be substituted was being operated under the manufacturer's recommended conditions.

The information in this section will be of some assistance in maintaining receivers for which direct replacement valves are no longer available. There can, of course, be no assurance that such sets will operate as efficiently with the substitute types.

MULLARD VALVE TYPE EF91—No supplies available

With circuit modifications this valve may be replaced by the Mullard Type EF9 in Mullard and Philips sets as detailed:

- (1) Lead to contact 5 disconnected and insulated.
- (2) Lead to contact 6 disconnected and extended, and fitted with top cap adaptor to reach the top cap of the EF9.
- (3) Join together contacts 4 and 5.
- (4) Reduce the anode load resistor from approximately 130,000 ohms to 50,000 ohms. It may be necessary to continue the screening on the lead formerly to contact 6 as far as the top cap, though in many cases this will not be necessary. Should the top cap of the EF9 touch the tuning scale it may be necessary to bend the platform for the EF91 slightly so as to give a small clearance. Under these conditions the set should operate as before but without the tuning indicator.

SUBSTITUTION OF TDD2A FOR THE 2D2

Change connections as below:

Connections for 2D2

Pin Number

1
2
3
4
5

Disconnect and take wire to
As at present
As at present
As at present
Disconnect and insulate end of lead

Connections for TDD2A

Pin Number

5
2
3
4
—

Also connect the earth end of the speech diode load to LT+, care being taken not to short out the grid bias supply.

Under these conditions the receiver should operate as before, but with a reduction of volume due to the removal of the A.V.C. delay voltage.

SUBSTITUTION OF TDD4 FOR THE SD4

Change connections as below:

Connections for SD4

Pin
Number

1
2
3
4
5
6
7

Not used with SD4
Disconnect and take this lead to
Disconnect and insulate end of lead
These connections remain as they are
at present
Disconnect and take lead to
Disconnect and take lead to

Connections for TDD4

Pin
Number

1
Top Cap

4
5
6
3
7

Top Cap

Join together pins 1 and 6.

In some cases the lead to the top cap may have to be screened.

SUBSTITUTION OF EB34 FOR THE EAB1

Contacts on—
EAB1 holder
No. 1 to

In Philips Receivers Types 753A and 895X,
also Mullard MAS17, MAS109 and
MAS12.

Circuit alterations:

1. Change valve holder to octal type.
2. Change connections as opposite.

	EB34 holder
2 to	1
3 to	2
4 to	7
5 to	4
7 insulate end of lead.	3
8 to	5
Join together pins 4 and 8.	

Under these conditions the set should operate as before, but without the A.V.C. delay characteristic.



9 VALVE DATA SUBSTITUTIONS FOR OBSOLETE TYPE VALVES

Original Type	Base	Substitute Type	Base	Remarks
ACO54	A	ACO44	A	Redesign circuit } There is no valve which will directly replace these valves, and full working conditions of the ACO44 should be studied before substitution is made.
ACO64	A	ACO44	A	
ACO84	A	ACO44	A	
ACO84N	A	ACO44	A	
AC104	A	ACO44	A	
AL60	M	PenB4	M	Re-wire base, change cathode resistance to 175 ohms. Pin No. $\begin{array}{cccccccc} 1 & 2 & 3 & 4 & 5 & 6 & 7 \\ \text{Conn.} & - & g1 & g2 & h & h & k & a \end{array}$
AZ2	P	FW4/500	A	Pin No. $\begin{array}{cccc} 1 & 2 & 3 & 4 \\ \text{Conn.} & a'' & a' & f & f \end{array}$
AZ3	P	IW4/350	A	No circuit change. Pin No. $\begin{array}{cccc} 1 & 2 & 3 & 4 \\ \text{Conn.} & a'' & a' & f & f \end{array}$
AZ32	K	FW4/500	A	Pin No. $\begin{array}{cccc} 1 & 2 & 3 & 4 \\ \text{Conn.} & a'' & a' & f & f \end{array}$
AZ33	K	IW4/350	A	No circuit change. Pin No. $\begin{array}{cccc} 1 & 2 & 3 & 4 \\ \text{Conn.} & a'' & a' & h & h, k \end{array}$
CL6	P	CL4	P	Change bias resistance to 170 ohms. Raise Vg2 to 200 V.
CY2	P	UR3C	M	No circuit change. Pin No. $\begin{array}{ccccccccc} 1 & 2 & 3 & 4 & 5 & 6 & 7 \\ \text{Conn.} & - & a' & k' & h & h & k'' & a'' \end{array}$
CY32	K	UR3C	M	No circuit change. Pin No. $\begin{array}{ccccccccc} 1 & 2 & 3 & 4 & 5 & 6 & 7 \\ \text{Conn.} & - & a' & k' & h & h & k'' & a'' \end{array}$
DAC1	P	DAC32	K	Pin No. $\begin{array}{cccccccc} 1 & 2 & 3 & 4 & 5 & 6 & 7 & 8 & \text{TC} \\ \text{Conn.} & M & f & a & - & a d & - & f & - & g1 \end{array}$
DF1	P	DF33	K	No circuit change. Pin No. $\begin{array}{cccccccc} 1 & 2 & 3 & 4 & 5 & 6 & 7 & 8 & \text{Tr} \\ \text{Conn.} & M & f+ & a & g2 & - & - & f, g3 & - & g1 \end{array}$
DK1	P	DK32	K	Pin No. $\begin{array}{cccccccc} 1 & 2 & 3 & 4 & 5 & 6 & 7 & 8 & \text{TC} \\ \text{Conn.} & M & f & a & g3 & g1 & g2 & f & - & g4 \end{array}$
DL2	P	DL35	K	Pin No. $\begin{array}{cccccccc} 1 & 2 & 3 & 4 & 5 & 6 & 7 & 8 \\ \text{Conn.} & - & f & a & g2 & g1 & - & f & - \end{array}$
DO25	A	DO30	A	Add series filament resistance of 1 ohm, 10 watts; no further change.
DT3 } DT30 }	A	DW4/500	A	Add series filament resistance of approx. 1.7 ohm, 10 watts; no further change.
DW3	A	DW4/350	A	No change.
DW4	A	{ DW4/500 FW4/500 }	A	No change.

VALVE DATA **9**
SUBSTITUTIONS FOR
OBSOLETE TYPE VALVES

Original Type	Base	Substitute Type	Base	Remarks
EAB1	P	EB34	K	Redesign circuit. (See instructions at beginning of list.)
EAF41	B8A	EAF42	B8A	Connect pins 4 and 7 together.
EB4	P	EB34	K	No circuit change. Pin No. <u>1 2 3 4 5 6 7 8</u> Conn. M, s h ad' k' ad" — h k'
ECC32	K	ECC33	K	No change.
ECH2	P	ECH3	P	No change. ECH3 $I_h = 0.2A$.
ECH33	K	{ CCH35 ECH35	K	For AC/DC receivers—CCH35. For AC receivers—ECH35.
EF2	P	EF9	P	EF9 has longer grid base.
EF5	P	EF9	P	No change.
EF6	P	EF36	K	Change base. Pin No. <u>1 2 3 4 5 6 7 8 TC</u> Conn. M h a g2 g3 — h k g1
EF8	P	EF9	P	No Change
EF38	K	EF39	K	No change.
EFM1	P	EF9	P	Redesign circuit without tuning indicator. (See instructions at beginning of list.)
EH2	P	ECH3	P	Use hexode section only in extreme cases.
EK3	P	EK2	P	Raise Vg2 to 200 V. EK2, $I_h = 0.2A$.
EL5	P	EL35	K	EL35 Vg2 = 250 V. max. Change bias resistance to 180 ohms. Pin No. <u>1 2 3 4 5 6 7 8</u> Conn. — h a g2 g1 — h k, g3
EL6	P	EL35	K	EL35 Vg2 = 250 V. max. Change bias resistance to 180 ohms. Pin No. <u>1 2 3 4 5 6 7 8</u> Conn. — h a g2 g1 — h g3, K
EL36	K	EL35	K	EL35 Vg2 = 250 V. max. Change bias resistance to 180 ohms.
EZ1	P	EZ35	K	Pin No. <u>1 2 3 4 5 6 7 8</u> Conn. — h a' — a' — h k $I_h = 0.6A$
IW3	A	IW4-350	A	No change.
IW4	A	IW4-500	A	No change.
MM4V	O	VP4	O	No change. Volume control will be less gradual in operation.
MW22-7	B8G	MW22-14C	B8G	No change.
MW31-7	B8G	MW31-14C	B8G	No change.

9 VALVE DATA SUBSTITUTIONS FOR OBSOLETE TYPE VALVES

Original Type	Base	Substitute Type	Base	Remarks																
Pen4V	O	Pen4VA	O	Change grid bias to -22 volts. No change with automatic bias.																
Pen4VB	M	PenA4	M	No change.																
Pen26	P	CL4	P	Change bias resistance to 170 ohms. CL4, $V_g=200$ volts.																
Pen40DD	M	CBL31	K	Change base. Pin No. <table style="display: inline-table; border-collapse: collapse; vertical-align: middle;"> <tr> <td style="border: none; padding: 0 5px;">1</td> <td style="border: none; padding: 0 5px;">2</td> <td style="border: none; padding: 0 5px;">3</td> <td style="border: none; padding: 0 5px;">4</td> <td style="border: none; padding: 0 5px;">5</td> <td style="border: none; padding: 0 5px;">6</td> <td style="border: none; padding: 0 5px;">7</td> <td style="border: none; padding: 0 5px;">8</td> </tr> <tr> <td style="border: none; padding: 0 5px;">Pen</td> <td style="border: none; padding: 0 5px;">h</td> <td style="border: none; padding: 0 5px;">a</td> <td style="border: none; padding: 0 5px;">d'</td> <td style="border: none; padding: 0 5px;">d''</td> <td style="border: none; padding: 0 5px;">g2</td> <td style="border: none; padding: 0 5px;">h,</td> <td style="border: none; padding: 0 5px;">k, g3</td> </tr> </table>	1	2	3	4	5	6	7	8	Pen	h	a	d'	d''	g2	h,	k, g3
1	2	3	4	5	6	7	8													
Pen	h	a	d'	d''	g2	h,	k, g3													
PM1A	A	PM2HL	A	No change.																
PM1HF	A	PM2HL	A	No change.																
PM1HL	A	PM2HL	A	No change.																
PM1LF	A	PM2HL	A	Change grid bias to -1.5 volts.																
PM2	A	PM2A	A	Change grid bias to -6.0 volts.																
PM2BA	M	PM2B	M	Remove bias supply from the valve.																
PM2DL	A	PM2HL	A	No change.																
PM2DX	A	PM2HL	A	No change.																
PM12	A	PM12M	A	Raise V_{g2} to 90 volts.																
PM12A	A	PM12M	A	Raise V_{g2} to 90 volts.																
PM22	A/O	PM22A	A/O	Change grid bias to -4.5 volts at $V_a=V_{g2}=135$ volts, and anode load to approx. 19,000 ohms.																
PM22D	O	PM22A	O	Increase bias to -4.5 V.																
PM24	A/O	PM24A	O	No circuit change. Pin No. <table style="display: inline-table; border-collapse: collapse; vertical-align: middle;"> <tr> <td style="border: none; padding: 0 5px;">1</td> <td style="border: none; padding: 0 5px;">2</td> <td style="border: none; padding: 0 5px;">3</td> <td style="border: none; padding: 0 5px;">4</td> <td style="border: none; padding: 0 5px;">5</td> </tr> <tr> <td style="border: none; padding: 0 5px;">Conn.</td> <td style="border: none; padding: 0 5px;">a</td> <td style="border: none; padding: 0 5px;">g1</td> <td style="border: none; padding: 0 5px;">f</td> <td style="border: none; padding: 0 5px;">g2</td> </tr> </table>	1	2	3	4	5	Conn.	a	g1	f	g2						
1	2	3	4	5																
Conn.	a	g1	f	g2																
PM24B	O	PM24M	O	Redesign circuit. PM24M $V_a=V_{g2}=250$ volts max.																
PM24C	O	PM24M	O	Redesign circuit. PM24M $V_a=V_{g2}=250$ volts max.																
PM252	A	PM2A	A	Anode load=7,000 ohms. Change bias to -6.0 volts.																
SD4	M	TDD4	M	Redesign circuit. (See instructions at beginning of list.)																
SP4C	P	SP4B	M	No circuit change. Pin No. <table style="display: inline-table; border-collapse: collapse; vertical-align: middle;"> <tr> <td style="border: none; padding: 0 5px;">1</td> <td style="border: none; padding: 0 5px;">2</td> <td style="border: none; padding: 0 5px;">3</td> <td style="border: none; padding: 0 5px;">4</td> <td style="border: none; padding: 0 5px;">5</td> <td style="border: none; padding: 0 5px;">6</td> <td style="border: none; padding: 0 5px;">7</td> <td style="border: none; padding: 0 5px;">TC</td> </tr> <tr> <td style="border: none; padding: 0 5px;">Conn.</td> <td style="border: none; padding: 0 5px;">M</td> <td style="border: none; padding: 0 5px;">a</td> <td style="border: none; padding: 0 5px;">g3</td> <td style="border: none; padding: 0 5px;">h</td> <td style="border: none; padding: 0 5px;">h</td> <td style="border: none; padding: 0 5px;">k</td> <td style="border: none; padding: 0 5px;">g2 g1</td> </tr> </table>	1	2	3	4	5	6	7	TC	Conn.	M	a	g3	h	h	k	g2 g1
1	2	3	4	5	6	7	TC													
Conn.	M	a	g3	h	h	k	g2 g1													
S4V	A/O	SP4	O	No circuit change. Pin No. <table style="display: inline-table; border-collapse: collapse; vertical-align: middle;"> <tr> <td style="border: none; padding: 0 5px;">1</td> <td style="border: none; padding: 0 5px;">2</td> <td style="border: none; padding: 0 5px;">3</td> <td style="border: none; padding: 0 5px;">4</td> <td style="border: none; padding: 0 5px;">5</td> <td style="border: none; padding: 0 5px;">TC</td> </tr> <tr> <td style="border: none; padding: 0 5px;">Conn.</td> <td style="border: none; padding: 0 5px;">g2</td> <td style="border: none; padding: 0 5px;">g1</td> <td style="border: none; padding: 0 5px;">h</td> <td style="border: none; padding: 0 5px;">h</td> <td style="border: none; padding: 0 5px;">k a</td> </tr> </table>	1	2	3	4	5	TC	Conn.	g2	g1	h	h	k a				
1	2	3	4	5	TC															
Conn.	g2	g1	h	h	k a															
S4VA	O	SP4	O	No change.																
S4VB	O	SP4	O	No change.																

VALVE DATA 9

SUBSTITUTIONS FOR OBSOLETE TYPE VALVES

Original Type	Base	Substitute Type	Base	Remarks																
TDD2	O	TDD2A	O	Change grid bias to -1.5 volts. Not suitable as Class B driver.																
TDD13	P	TDD13C	M	No circuit change. Pin No. <table style="display: inline-table; border-collapse: collapse;"><tr><td style="border: none;">1</td><td style="border: none;">2</td><td style="border: none;">3</td><td style="border: none;">4</td><td style="border: none;">5</td><td style="border: none;">6</td><td style="border: none;">7</td><td style="border: none;">TC</td></tr><tr><td style="border: none;">Conn.</td><td style="border: none;">ad'</td><td style="border: none;">M</td><td style="border: none;">ad'</td><td style="border: none;">h</td><td style="border: none;">h</td><td style="border: none;">k</td><td style="border: none;">a gl</td></tr></table>	1	2	3	4	5	6	7	TC	Conn.	ad'	M	ad'	h	h	k	a gl
1	2	3	4	5	6	7	TC													
Conn.	ad'	M	ad'	h	h	k	a gl													
TH4	M	TH4B	M	Change bias resistance to 140 ohms. Grid leak to be increased to 47,000 ohms between oscillator grid and cathode.																
TH4A	M	TH4B	M	No change.																
TH22C	M	TH30C	M	No change.																
TH62	K	{ CCH35 } { ECH35 }	K	For AC/DC receivers—CCH35. For AC receivers—ECH35. No change.																
TV6	P	EM1	P	No change.																
UAF41	B8A	UAF42	B8A	Connect pins 4 and 7 together.																
UR1	P	CY1	P	No change.																
UR2	P	UR3C	M	No circuit change. Pin No. <table style="display: inline-table; border-collapse: collapse;"><tr><td style="border: none;">1</td><td style="border: none;">2</td><td style="border: none;">3</td><td style="border: none;">4</td><td style="border: none;">5</td><td style="border: none;">6</td><td style="border: none;">7</td></tr><tr><td style="border: none;">Conn.</td><td style="border: none;">—</td><td style="border: none;">a'</td><td style="border: none;">k'</td><td style="border: none;">h</td><td style="border: none;">h</td><td style="border: none;">k'</td><td style="border: none;">a'</td></tr></table>	1	2	3	4	5	6	7	Conn.	—	a'	k'	h	h	k'	a'	
1	2	3	4	5	6	7														
Conn.	—	a'	k'	h	h	k'	a'													
UR3	P	UR3C	M	No circuit change. Pin No. <table style="display: inline-table; border-collapse: collapse;"><tr><td style="border: none;">1</td><td style="border: none;">2</td><td style="border: none;">3</td><td style="border: none;">4</td><td style="border: none;">5</td><td style="border: none;">6</td><td style="border: none;">7</td></tr><tr><td style="border: none;">Conn.</td><td style="border: none;">—</td><td style="border: none;">a'</td><td style="border: none;">k'</td><td style="border: none;">h</td><td style="border: none;">h</td><td style="border: none;">k'</td><td style="border: none;">a'</td></tr></table>	1	2	3	4	5	6	7	Conn.	—	a'	k'	h	h	k'	a'	
1	2	3	4	5	6	7														
Conn.	—	a'	k'	h	h	k'	a'													
UY31	K	UY21	B8G	Change base. Pin No. <table style="display: inline-table; border-collapse: collapse;"><tr><td style="border: none;">1</td><td style="border: none;">2</td><td style="border: none;">3</td><td style="border: none;">4</td><td style="border: none;">5</td><td style="border: none;">6</td><td style="border: none;">7</td><td style="border: none;">8</td></tr><tr><td style="border: none;">Conn.</td><td style="border: none;">h</td><td style="border: none;">a</td><td style="border: none;">—</td><td style="border: none;">a</td><td style="border: none;">—</td><td style="border: none;">a</td><td style="border: none;">k h</td></tr></table>	1	2	3	4	5	6	7	8	Conn.	h	a	—	a	—	a	k h
1	2	3	4	5	6	7	8													
Conn.	h	a	—	a	—	a	k h													
VM4V	O	VP4	O	No change. Volume control will not be so gradual in operation.																
O54V	O	ACO44	A	Redesign circuit.																
IA7G	K	DK32	K	Earth pin 1.																
IC5G	K	DL35	K	No change.																
IH5G	K	DAC32	K	Earth pin 1.																
IN5G	K	DF33	K	Earth pin 1.																
2D2	O	TDD2A	O	Redesign circuit. (See instructions at beginning of list.)																
2D4	O	2D4A	O	No circuit change. Pin No. <table style="display: inline-table; border-collapse: collapse;"><tr><td style="border: none;">1</td><td style="border: none;">2</td><td style="border: none;">3</td><td style="border: none;">4</td><td style="border: none;">5</td></tr><tr><td style="border: none;">Conn.</td><td style="border: none;">ad'</td><td style="border: none;">ad'</td><td style="border: none;">h</td><td style="border: none;">h k</td></tr></table> 2D4A has no top cap.	1	2	3	4	5	Conn.	ad'	ad'	h	h k						
1	2	3	4	5																
Conn.	ad'	ad'	h	h k																
2D13	V	EB34	K	As for 2D13C.																
2D13A	V	EB34	K	As for 2D13C.																

9 VALVE DATA SUBSTITUTIONS FOR OBSOLETE TYPE VALVES

Original Type	Base	Substitute Type	Base	Remarks								
2D13C	○	EB34	K	Change base. Pin No. <table style="display: inline-table; border-collapse: collapse;"> <tr> <td style="border: 1px solid black; padding: 2px;">1</td> <td style="border: 1px solid black; padding: 2px;">2</td> <td style="border: 1px solid black; padding: 2px;">3</td> <td style="border: 1px solid black; padding: 2px;">4</td> <td style="border: 1px solid black; padding: 2px;">5</td> <td style="border: 1px solid black; padding: 2px;">6</td> <td style="border: 1px solid black; padding: 2px;">7</td> <td style="border: 1px solid black; padding: 2px;">8</td> </tr> </table> Conn. Ms h ad' k' ad' — h k' When re-wiring connect separate cathodes of EB34 together. EB34, Vh=6.3 V.	1	2	3	4	5	6	7	8
1	2	3	4	5	6	7	8					
3Q5G	K	DL33	K	No change.								
164V	○	TT4	○	In R-C stage increase Rk to 10,000 Ω and Ra to 82,000 Ω.								
244V	○	354V	○	No change.								
484V	○	354V	○	Change grid bias to -4.5 volts or bias resistance to 700 ohms.								

RESISTOR AND CAPACITOR COLOUR CODES

RESISTOR COLOUR CODE

The British system of colour coding for fixed resistors is indicated by one or the other of two methods illustrated in Figs. A and B below.

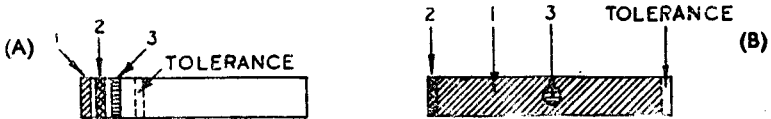

In method A the colours are read from the end of the resistor adjacent to the colour bands. In method B the sequence is : body colour, tip colour, and spot or band colour. The third colour always indicates the number of "noughts" following the first two numerals.

The colour code is as follows :

Black 0	Brown 1	Red 2	Orange 3	Yellow 4
Green 5	Blue 6	Violet 7	Grey 8	White 9

If a fourth band is added on resistors marked by method A, or an additional tip in method B, it indicates the tolerance according to the following code :

Gold $\pm 5\%$ tolerance	Silver $\pm 10\%$ tolerance
--------------------------	-----------------------------

If this fourth metallic indication is absent, the tolerance is assumed to be $\pm 20\%$.

EXAMPLES

- (1) RED-GREEN-ORANGE-SILVER $25,000 \Omega \pm 10\%$
- (2) YELLOW-VIOLET-BLACK-GOLD $47 \Omega \pm 5\%$
- (3) BLUE-GREY-BROWN $680 \Omega \pm 20\%$

CAPACITOR COLOUR CODE

Up to six colours are sometimes used to indicate the capacity in micro-microfarads, the direct current voltage rating and the tolerance. The sequence of colours is shown by an arrow or some such device and the code is as follows :

- First colour First figure.
- Second colour Second figure.
- Third colour Third figure.
- Fourth colour Number of "noughts" following the first three figures.
- Fifth colour Direct current voltage test rating.
- Sixth colour Percentage tolerance, plus or minus.

	First Four Colours (Numerals and Noughts)	Fifth Colour (D.C. voltage test rating)	Sixth Colour (Tolerance %)
Black	0	0	0
Brown	1	100	1
Red	2	200	2
Orange	3	300	3
Yellow	4	400	4
Green	5	500	5
Blue	6	600	6
Violet	7	700	7
Grey	8	800	8
White	9	900	9
Gold	0.1 (fourth colour only)	1,000	5
Silver	0.01 (fourth colour only)	2,000	10
No colour	—	500	20

EXAMPLES

- (1) ORANGE-GREEN-BLACK-BROWN-GREEN or NO COLOUR-SILVER = $3,500 \mu\mu\text{F}$, 500-volt D.C. test rating, 10% tolerance.
- (2) YELLOW-VIOLET-BLACK-BLACK-GOLD-RED = $470 \mu\mu\text{F}$, 1,000-volt D.C. test rating, 2% tolerance.



B STANDARD RESISTOR VALUES

The standardisation of fixed resistor values has been introduced to obviate, as far as possible, the use of a large number of intermediate values. Tolerance ranges of 5%, 10%, 20% and 33½% are included, identification being by means of gold, silver, no colour and white (where distinguishable) rings or dots respectively. In modern radio receiver practice, however, it is usual to adhere to either the 10% or the 20% tolerance range, the former being used only where essential.

20% TOLERANCE RANGE

In the following table the standard resistor values in ohms are shown in heavy type in the left-hand column whilst the resistor range these are intended to cover is given in the right-hand column.

10	10- 12	1,000	800- 1,200	100,000	80,000-120,000
15	12- 18	1,500	1,200- 1,800	150,000	120,000-180,000
22	18- 26	2,200	1,760- 2,640	220,000	176,000-264,000
33	27- 39	3,300	2,640- 3,960	330,000	264,000-396,000
47	38- 56	4,700	3,760- 5,640	470,000	376,000-564,000
68	55- 81	6,800	5,440- 8,160	680,000	544,000-816,000
100	80-120	10,000	8,000-12,000	1.0 Meg	0.8 Meg- 1.2 Meg
150	120-180	15,000	12,000-18,000	1.5 Meg	1.2 Meg- 1.8 Meg
220	178-264	22,000	17,600-26,400	2.2 Meg	1.76 Meg- 2.64 Meg
330	264-396	33,000	26,400-39,600	3.3 Meg	2.64 Meg- 3.96 Meg
470	376-564	47,000	37,600-56,400	4.7 Meg	3.76 Meg- 5.64 Meg
680	544-820	68,000	54,400-81,600	6.8 Meg	5.44 Meg- 8.16 Meg
				10.0 Meg	8.0 Meg-10.0 Meg

10% TOLERANCE RANGE

The following table lists the standard resistor values in ohms, comprising the 10% Tolerance Range. Each resistor covers values within $\pm 10\%$ of its nominal value.

10	100	1,000	10,000	100,000	1.0 Meg
12	120	1,200	12,000	120,000	1.2 Meg
15	150	1,500	15,000	150,000	1.5 Meg
18	180	1,800	18,000	180,000	1.8 Meg
22	220	2,200	22,000	220,000	2.2 Meg
27	270	2,700	27,000	270,000	2.7 Meg
33	330	3,300	33,000	330,000	3.3 Meg
39	390	3,900	39,000	390,000	3.9 Meg
47	470	4,700	47,000	470,000	4.7 Meg
56	560	5,600	56,000	560,000	5.6 Meg
68	680	6,800	68,000	680,000	6.8 Meg
82	820	8,200	82,000	820,000	8.2 Meg



The tables on this page are reprinted from "Radio Designer's Handbook", F. Langton Smith, published in England by Iliffe & Sons, Ltd.

GENERAL TECHNICAL DATA INDUCTIVE AND CAPACITIVE REACTANCES

10
C

REACTANCE IN OHMS AT AUDIO FREQUENCIES

Inductance (henries)	30 c/s	50 c/s	100 c/s	400 c/s	1000 c/s	5000 c/s
250	47,100	78,500	157,000	628,000	1,570,000	7,850,000
100	18,800	31,400	62,800	251,000	628,000	3,140,000
50	9,420	15,700	31,400	126,000	314,000	1,570,000
25	4,710	7,850	15,700	62,800	157,000	785,000
10	1,880	3,140	6,280	25,100	62,800	314,000
5	942	1,570	3,140	12,600	31,400	157,000
1	188	314	628	2,510	6,280	31,400
.1	18.8	31.4	62.8	251	628	3,140
.01	1.88	3.14	6.28	25.1	62.8	314
1000 μ H	0.188	0.314	0.628	2.51	6.28	31.4
200 μ H	0.0376	0.0628	0.126	0.502	1.26	6.28
100 μ H	0.0188	0.0314	0.0628	0.251	0.628	3.14

REACTANCE IN OHMS AT RADIO FREQUENCIES

Inductance (henries)	175 Kc/s	252 Kc/s	465 Kc/s	550 Kc/s	1000 Kc/s	1500 Kc/s
1	1,100,000	1,580,000	2,920,000	3,460,000	6,280,000	9,430,000
.1	110,000	158,000	292,000	346,000	628,000	943,000
.01	11,000	15,800	29,200	34,600	62,800	94,300
1000 μ H	1,100	1,580	2,920	3,460	6,280	9,430
200 μ H	220	317	484	691	1,260	1,890
100 μ H	110	158	292	346	628	943

REACTANCE IN OHMS AT AUDIO FREQUENCIES

Capacitance Microfarads	30 c/s	50 c/s	100 c/s	400 c/s	1000 c/s	5000 c/s
.00005	—	—	—	—	—	637,000
.0001	—	—	—	—	1,590,000	318,000
.00025	—	—	—	1,590,000	637,000	127,000
.0005	—	—	3,180,000	796,000	318,000	63,700
.001	—	3,180,000	1,590,000	398,000	159,000	31,800
.005	1,060,000	637,000	318,000	79,600	31,800	6,370
.01	531,000	318,000	159,000	39,800	15,900	3,180
.02	263,000	159,000	79,600	19,900	7,960	1,590
.05	106,000	63,700	31,800	7,960	3,180	637
.1	53,100	31,800	15,900	3,980	1,590	318
.25	21,200	12,700	6,370	1,590	637	127
.5	10,600	6,370	3,180	796	318	63.7
1	5,310	3,180	1,590	389	159	31.8
2	2,650	1,590	796	199	79.6	15.9
4	1,310	796	398	99.5	39.8	7.96
8	663	398	199	49.7	19.9	3.98
16	332	199	99.5	24.9	9.95	1.99
25	212	127	63.7	15.9	6.37	1.27
35	152	91	45.5	11.4	4.55	0.91

REACTANCE IN OHMS AT RADIO FREQUENCIES

Capacitance Microfarads	175 Kc/s	252 Kc/s	465 Kc/s	550 Kc/s	1000 Kc/s	1500 Kc/s
.00005	18,200	12,600	6,850	5,800	3,180	2,120
.0001	9,100	6,320	3,420	2,900	1,590	1,060
.00025	3,640	2,530	1,370	1,160	637	424
.0005	1,820	1,260	685	579	318	212
.001	910	632	342	290	159	106
.005	182	126	68.5	57.9	31.8	21.2
.01	91	63.2	34.2	28.9	15.9	10.6
.02	45.5	31.6	17.1	14.5	7.96	5.31
.05	18.2	12.6	6.85	4.79	3.18	2.12
.1	9.1	6.32	3.42	2.89	1.59	1.06
.25	3.64	2.53	1.37	1.16	0.637	0.424
.5	1.82	1.26	0.685	0.579	0.318	0.212
1	0.91	0.632	0.342	0.289	0.159	0.106
2	0.455	0.316	0.171	0.145	0.0796	0.0531
4	0.227	0.158	0.0856	0.0723	0.0398	0.0265



D ABAC — OHM'S LAW

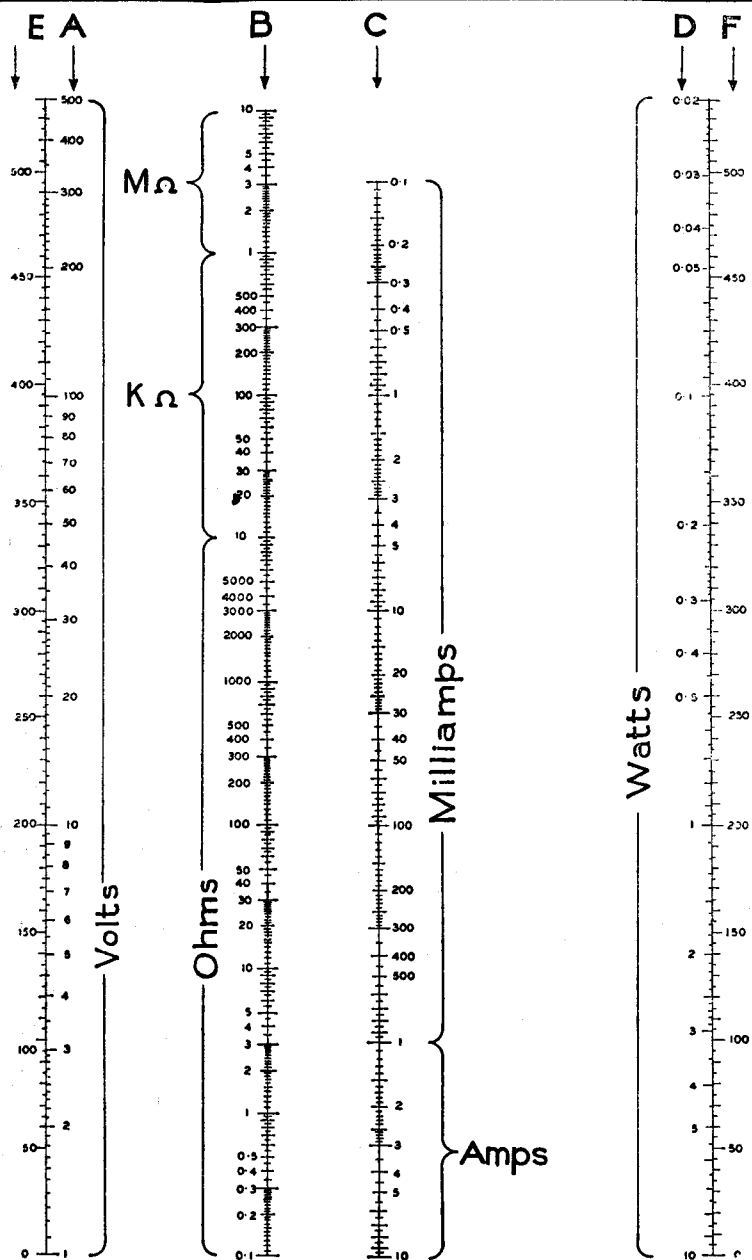

OHM'S LAW

If any two of the quantities (volts, amperes, ohms or watts) are known, the remaining two can be found by placing a straight edge across the scales A, B, C, D, so that it coincides with the values of the two known quantities.

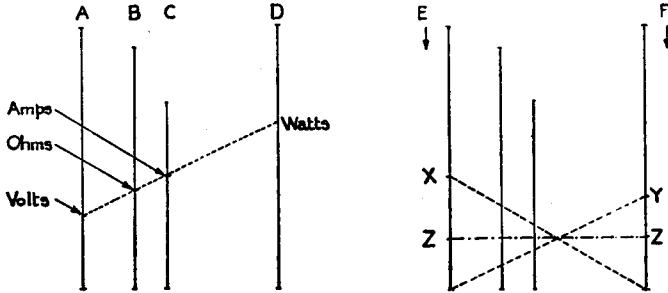
**RESISTORS IN PARALLEL**

To find the resultant resistance of two or more resistors in parallel use scales E and F.

Select a point on scale E corresponding to the ohmic value of one resistor (X) and join X to the bottom of scale F. Select a point on scale F corresponding to the ohmic value of the second resistor (Y) and join Y to the bottom of scale E. The intersection of these two lines projected on either scale E or scale F (Z) gives the resultant resistance to the same units.

EXAMPLE 1

To find the resultant resistance of 17,000 ohms and 9,000 ohms in parallel, X may be selected as 170 and Y as 90. Point Z will be found to be 59, and the resultant resistance is thus 5,900 ohms.

If the resultant resistance of more than two resistors in parallel is required, the resultant resistance of the first two should be found as described above, and the answer combined with the third resistor in the same way and so on.

EXAMPLE 2

To find the resultant resistance of 17,000, 9,000 and 3,000 ohms in parallel. The resultant resistance of 17,000 ohms and 9,000 ohms is 5,900 ohms (see Example 1). This figure now becomes the new point X (59) on Scale E and 3,000 ohms is represented by a new point Y (30) on Scale F. Proceeding as in Example 1, the final resultant will be found to be 19.9 on Scale E or F, i.e. 1,990 ohms.

The above operations can, of course, be performed in reverse to determine what combination of standard resistors can be used in parallel to obtain any desired resultant resistance.

CAPACITORS IN SERIES

Exactly the same procedure can be employed for determining the resultant capacitance of two or more capacitors in series.



E DECIBEL CONVERSION CHART

The relation between Voltage, Current or Power Ratios and Decibels is:—

Voltage $20 \log \frac{V_1}{V_2} = \text{decibels.}$

Current $20 \log \frac{I_1}{I_2} = \text{decibels.}$

Power $10 \log \frac{P_1}{P_2} = \text{decibels.}$

The chart reproduced below enables gain ratios to be converted to decibels direct. The conversion of voltage or current ratios, however, is correct only when the two powers compared are dissipated in equal impedances.

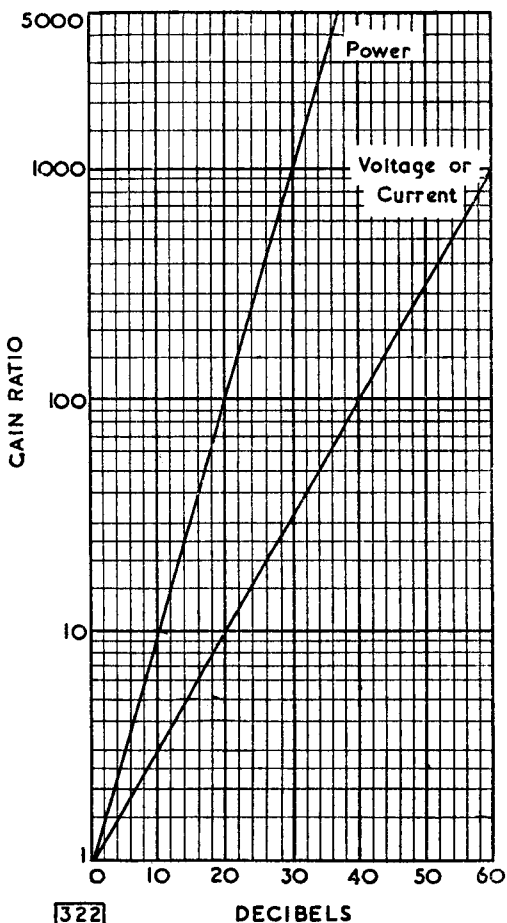

322

DECIBELS

B.B.C. TELEVISION FREQUENCY ALLOCATIONS F

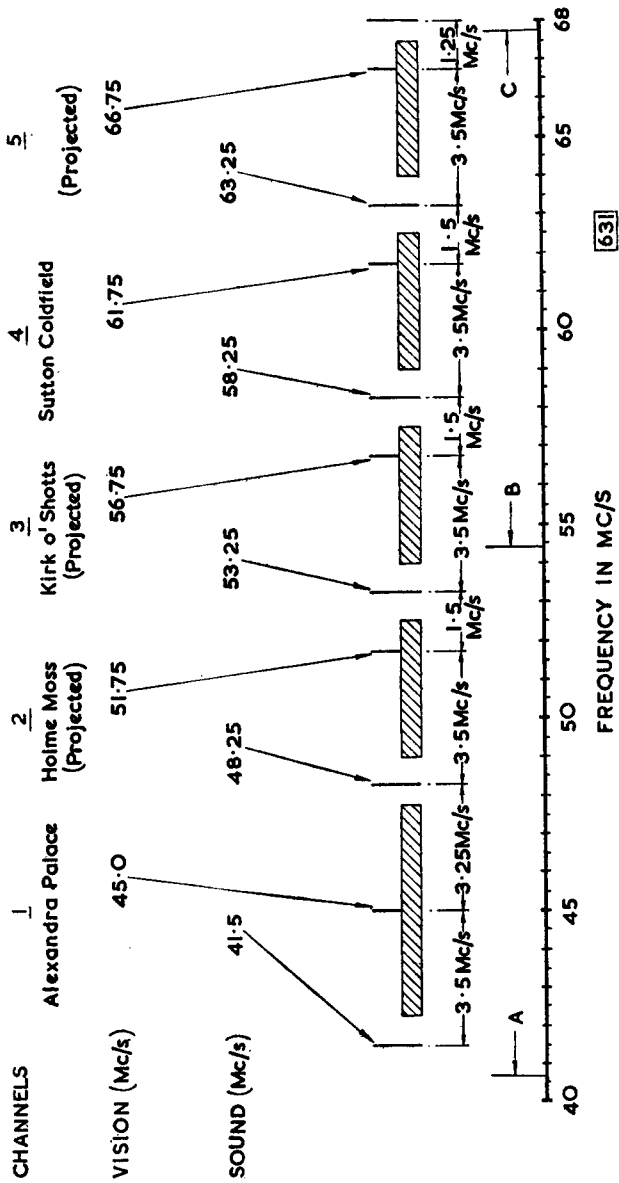

B.B.C. Television Service Frequency Allocations for 5 Channels in the 40—68 Mc/s Waveband. 631

A., B. and C. are respectively the Fundamental, 2nd Harmonic and 5th Harmonic of the Industrial (or Medical) Frequency—40.68 ± 0.05%



10 GENERAL DESIGN DATA G WAVELENGTH-FREQUENCY CHART

The tables on this page are reprinted from "Radio Designer's Handbook", F. Langton Smith, published in England by Illiffe and Sons Ltd.

Wavelength-Frequency Conversion Chart

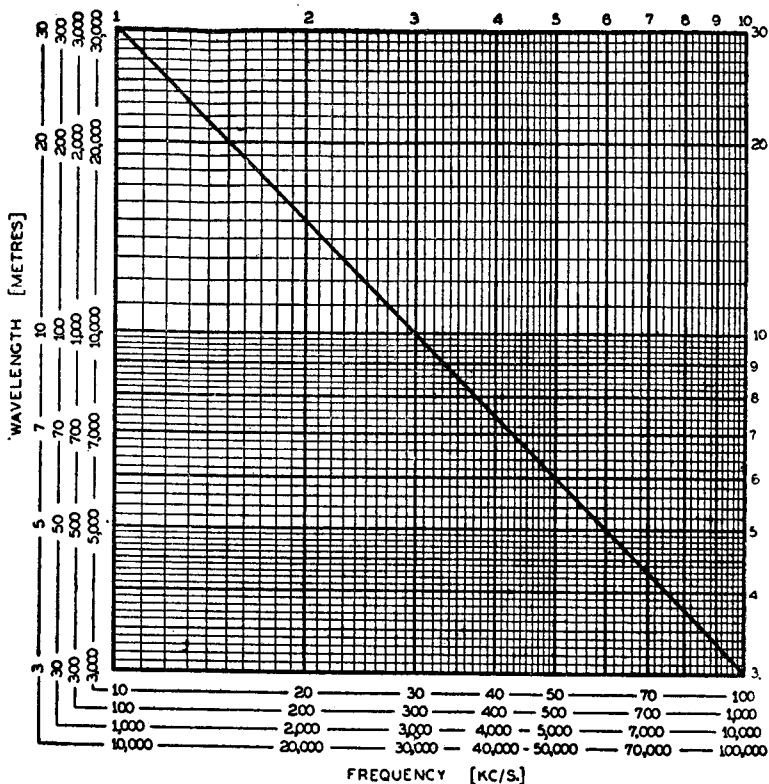

Wavelength-Frequency Conversion Table Convenient Points Selected for Rapid Reference.

Broadcast Band				Short Waves			
Fre- quency Kc/s.	Wave- length Metres	Fre- quency Kc/s.	Wave- length Metres	Fre- quency Mc/s.	Wave- length Metres	Fre- quency Mc/s.	Wave- length Metres
550	545	1050	286	1.5	200	11	27.3
600	500	1100	273	2	150	12	25.0
650	461	1150	261	3	100	13	23.1
700	429	1200	250	4	75.0	14	21.4
750	400	1250	240	5	60.0	15	20.0
800	375	1300	231	6	50.0	16	18.8
850	353	1350	222	7	42.9	17	17.6
900	333	1400	214	8	37.5	18	16.7
950	316	1450	207	9	33.3	19	15.8
1000	300	1500	200	10	30.0	20	15.0

PHOTOCELLS

Mullard photocells are of the emissive type, that is to say, the current through a cell is due to the emission of electrons due to light falling upon a cold cathode, no power being required for cathode heating. The cells are manufactured in a range of forms and sizes, and fall into two general classes :—

1. High Vacuum Cells—denoted by letter "V"—e.g., 20 CV.
2. Gasfilled Cells—denoted by letter "G"—e.g. 20 CG.

High Vacuum Cells possess the following advantages :—

- (a) Provided the anode voltage exceeds a certain value known as the "saturation value," and which is in the order of 20 V, the sensitivity of the cell is practically independent of the anode voltage. This means that the anode current depends only on the amount of light falling on the cathode. They may therefore be used where quantitative readings are required.
- (b) If the cell is operated under the recommended conditions its characteristics will remain substantially constant over long periods of time, and in comparison with gas-filled cells, are not so seriously affected by accidentally applied excess voltages.

Gasfilled Cells possess the advantage of higher sensitivity due to amplification by gas ionisation within the cell. The gas amplification rises with increasing anode voltage and also with increasing intensity of illumination. This means that the anode current depends upon the anode voltage, upon the total amount of light falling upon the cathode and also upon the intensity of the light. Gasfilled cells, therefore, are not suitable in general for applications involving measurement, but are employed mainly for "on-off" applications. A disadvantage of the gasfilled cell is that it may suffer permanent damage due to gas discharge if subjected to anode voltages in excess of those specified. It is therefore recommended that a resistor of at least 0.1 M be included in series with the cell, to limit the effect of gas discharge due to unintentional over-running. Gas discharge manifests itself by a faint blue glow within the tube.

RESPONSE TO ILLUMINATION

Under given electrical conditions, and for light of a given colour composition, the current passed by a photocell depends upon the amount of light falling upon the cathode. The sensitivity of the cell, however, depends upon the colour composition of the light. Two types of cathode material are used :—

- (a) **Caesium on silver oxide** cathodes have maximum sensitivity to incandescent light and near infra-red radiation. Cells having this type of cathode are denoted by the letter "C"—e.g. 20 CV.
- (b) **Caesium on antimony** cathodes have high sensitivity to daylight and to light with blue predominance. Cells having this type of cathode are denoted by the letter "A"—e.g., 20 AV.



PHOTOCELLS (contd)

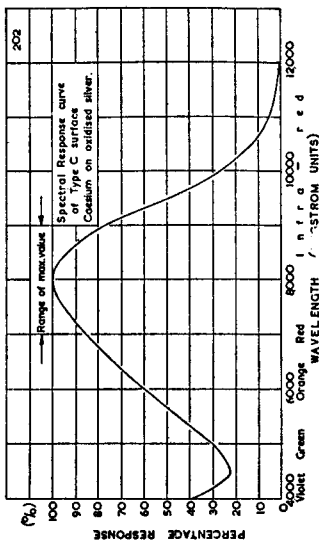
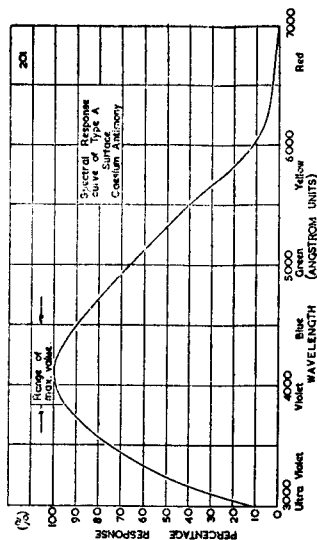

Spectral response curves for the two types are reproduced on the page opposite. **Measurement of Light.** The unit of light flux is the *lumen* and the sensitivity of a photocell is quoted as the current (in micro-amperes) passed by the cell per lumen of light falling on the cathode.

The amount of light falling on cathode having an area of A sq. cms. is:—

$$L = \frac{E \times W \times A}{4\pi d^2}$$

where "d" is the distance in cms between the lamp and the filament, W is the wattage of the lamp, and E is the light efficiency of the lamp in lumens per watt. As a guide in determining the approximate amount of light on the cathode of a photocell, it may be stated the light efficiency "E" of a 60-watt 230-volt single coil tungsten gasfilled lamp is 9.2 lumens per watt.

For a 12-volt 36-watt "V" filament car headlight bulb without reflector mounted base downward, and with the plane of the filament parallel to the cathode of the photocell, the following intensities are obtained:—

Distance.	Lumens per sq. cm. of cathode area.
1 ft.	0.075
5 ft.	0.003
10 ft.	0.00075

Effect of Exposure to Intense Illumination. If a photocell is exposed to intense illumination such as direct sunlight, the sensitivity may decrease temporarily, even if no voltage is applied to the cell. It is therefore recommended that photocells should be stored in the dark.

Effect of Ambient Temperature. The maximum ambient temperature specified for each type of cell is the temperature of the surrounding air above which the emissive coating of the cathode may evaporate, with consequent reduction of the life and sensitivity of the cell.



OHM'S LAW

$$I = \frac{E}{R}$$

where I = current in amperes,
E = voltage in volts, and
R = resistance in ohms

A convenient method of memorising Ohm's Law is by setting it out thus :

$$\frac{\text{Volts}}{\text{Amps} \times \text{Ohms}}$$

when, in order to find the unknown value, the latter should be covered and the remaining calculation performed.

RESISTORS IN PARALLEL

$$R_s = \frac{1}{\frac{1}{R_1} + \frac{1}{R_2} + \frac{1}{R_3} + \dots + \frac{1}{R_n}}$$

CAPACITORS IN SERIES

$$C = \frac{1}{\frac{1}{C_1} + \frac{1}{C_2} + \frac{1}{C_3} + \dots + \frac{1}{C_n}}$$

REACTANCE OF COIL

$X_L = 2\pi fL$
where $\pi = 3.14$
f = frequency in cycles per second
L = inductance in henrys

REACTANCE OF A CAPACITOR

$X_C = \frac{10^6}{2\pi fC}$
where C is the capacitance in microfarads

RESONANT FREQUENCY OF TUNED CIRCUIT

$$f = \frac{1}{2\pi\sqrt{LC}}$$

where f = frequency in cycles per second
 $\pi = 3.14$
L = inductance in henrys
C = capacitance in farads

In making radio frequency calculations it is more convenient to reduce L and C to smaller units so that f may be expressed in megacycles. The three equations then become :

$$f^2 = \frac{25,330}{LC} \text{ or } L = \frac{25,330}{f^2 C} \text{ or } C = \frac{25,330}{f^2 L}$$

where f = frequency in megacycles
L = inductance in microhenrys, and
C = capacity in micro-micro-farads



10 GENERAL TECHNICAL DATA

I USEFUL FORMULAE

TIME CONSTANT OF RESISTANCE AND CAPACITANCE IN SERIES

$$T = R \times C$$

where T is the time constant in seconds, R in ohms and C in farads

STAGE GAIN—VALVE AMPLIFIER

$$M = \frac{\mu R_a}{r_a + R_a}$$

where μ = amplification factor of valve

r_a = impedance of valve

R_a = anode load resistor in ohms

OUTPUT TRANSFORMER RATIO

$$N = \sqrt{\frac{R_a}{Z}}$$

where N = turns ratio

R_a = optimum load resistance of valve

Z = impedance of loudspeaker

	<i>Pages</i>
4-Valve Miniature Battery-Operated Receiver	228-229
1+I-Valve A.C. Mains-Operated Superheterodyne Receiver ...	230-231
3+I-Valve D.C./A.C. Mains-Operated Superheterodyne Receiver ...	232-234
3-Valve Battery-Operated Gramophone Amplifier	235
3-Watt A.C. Mains-Operated A.F. Amplifier with Selective Feedback	236-237
10-Watt D.C./A.C. Mains-Operated Push-Pull A.F. Amplifier	238-239
10-Watt A.C. Mains-Operated Push-Pull A.F. Amplifier	240-241
30-Watt A.C. Mains-Operated Push-Pull A.F. Amplifier	240-242
Amplifier Time Base, and Power Supply Unit for Oscilloscope ...	243-245
Voltage-Regulated Power Supply Unit	246
Portable Battery-Operated Photographic Flash Equipment	247



CIRCUITS

4-VALVE MINIATURE BATTERY-OPERATED RECEIVER

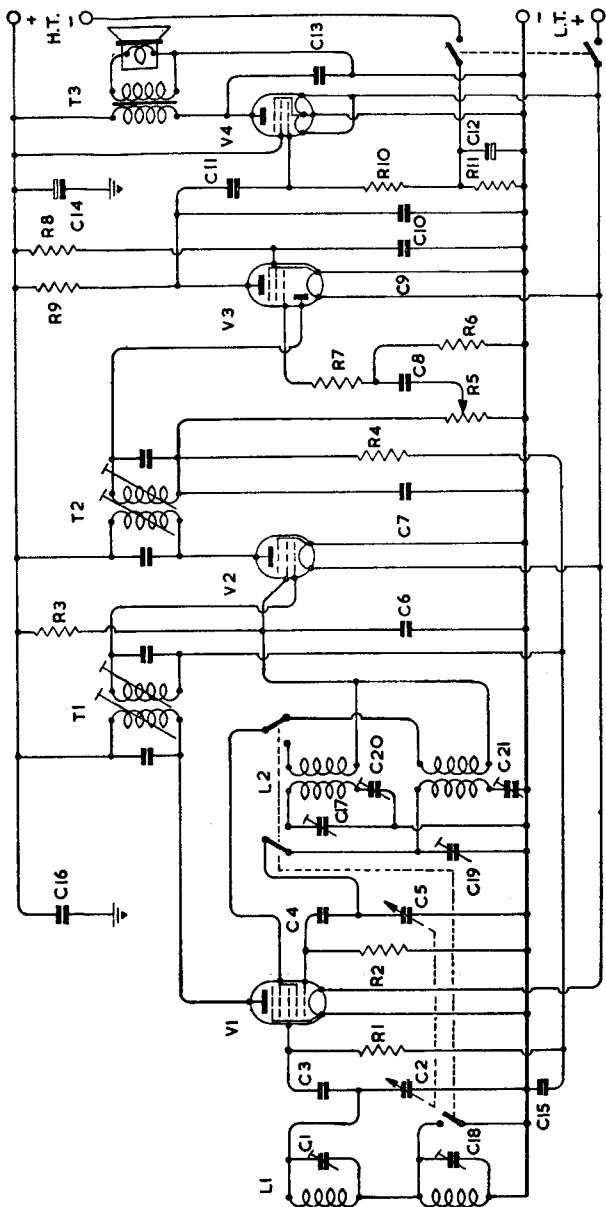

4-VALVE MINIATURE BATTERY-OPERATED RECEIVER

Provision is made for long and medium wave reception by the use of switched coils. In order to obtain a balanced remote cut-off characteristic for the frequency changer and the I.F. amplifier, the screen grids of both valves are fed from a common voltage-dropping resistor. This mode of operation reduces modulation distortion.

L1 may conveniently consist of a frame aerial.

RESISTORS

R1	1.0 M Ω	$\frac{1}{2}$ W
R2	100 K Ω	$\frac{1}{2}$ W
R3	27 K Ω	$\frac{1}{2}$ W
R4	2.2 M Ω	$\frac{1}{2}$ W
R5	1.0 M Ω potentiometer	
R6	6.8 M Ω	$\frac{1}{2}$ W
R7	22 K Ω	$\frac{1}{2}$ W
R8	2.2 M Ω	$\frac{1}{2}$ W
R9	470 K Ω	$\frac{1}{2}$ W
R10	1.0 M Ω	$\frac{1}{2}$ W
**R11	{ 1,000 Ω 470 Ω	$\frac{1}{2}$ W

VALVES

V1	DK91
V2	DF91
V3	DAF91
**V4	{ DL92 DL94

CAPACITORS

*C1, C18	Aerial trimmers		
*C2	Aerial tuning	0.0005 μ F	
C3	0.0001 μ F	—	
C4	0.0001 μ F	—	
*C5	Oscillator tuning	0.0005 μ F	
C6	0.1 μ F	200	V
C7	0.0001 μ F	—	
C8	0.005 μ F	—	
C9	0.1 μ F	200	V
C10	0.0001 μ F	—	
C11	0.01 μ F	—	
†C12	25 μ F	12	V
C13	0.005 μ F	150	V
†C14	2.0 μ F	150	V
C15	0.1 μ F	—	
C16	0.1 μ F	—	
*C17, C19	Oscillator Trimmers		
*C20, C21	Oscillator padders		

*Variable

†Electrolytic

TRANSFORMERS

- T1, T2 465 Kc/s Intermediate frequency transformers.
 **T3 Output transformer. Ratio—44:1 for speech coil Impedance of 2-3 ohms.

OPERATING VOLTAGES

HT voltage 90 V LT voltage 1.5 V

**A more sensitive receiver can be made by using DL94 instead of DL92 in the output stage. In this case R11 should be 470 Ω and T3 should have a ratio of 62:1.



CIRCUITS

4+1-VALVE A.C. MAINS-OPERATED SUPERHETERODYNE RECEIVER

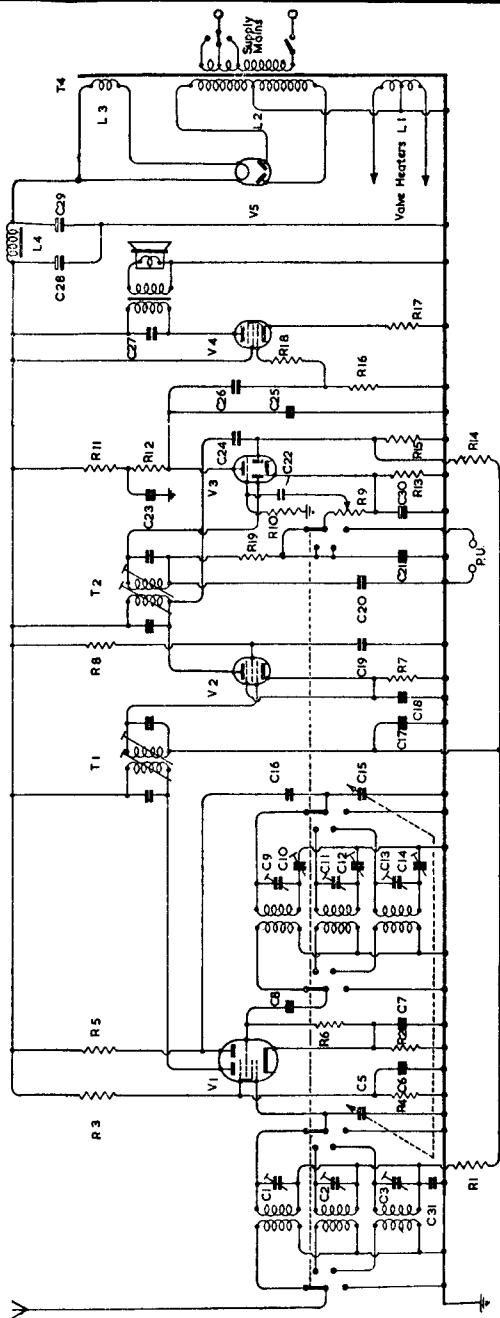

4+1-VALVE A.C. MAINS-OPERATED SUPERHETERODYNE RECEIVER

Provision is made for long, medium and short wave reception and gramophone reproduction by means of a five-bank, four-way rotary switch, the un-by-passed cathode resistor R17 provides a degree of negative feedback.

RESISTORS

R1	1.2 M Ω	$\frac{1}{2}$ W
R2	180 Ω	$\frac{1}{2}$ W
R3	27 K Ω	$\frac{1}{2}$ W
R4	47 K Ω	$\frac{1}{2}$ W
R5	33 K Ω	$\frac{1}{2}$ W
R6	47 K Ω	$\frac{1}{2}$ W
R7	150 Ω	$\frac{1}{2}$ W
R8	47 K Ω	$\frac{1}{2}$ W
R9	0.5 M Ω potentiometer	$\frac{1}{2}$ W
R10	470 K Ω	$\frac{1}{2}$ W
R11	22 K Ω	$\frac{1}{2}$ W
R12	150 K Ω	$\frac{1}{2}$ W
R13	3,300 Ω	$\frac{1}{2}$ W
R14	1.2 M Ω	$\frac{1}{2}$ W
R15	1.2 M Ω	$\frac{1}{2}$ W
R16	470 K Ω	$\frac{1}{2}$ W
R17	180 Ω	$\frac{1}{2}$ W
R18	50 K Ω	$\frac{1}{2}$ W
R19	50 K Ω	$\frac{1}{2}$ W

VALVES

V1	ECH42
V2	EF41
V3	EBC41
V4	EL41
V5	EZ40

CAPACITORS

*C1	Aerial SW trimmer	
*C2	Aerial MW trimmer	
*C3	Aerial LW trimmer	
*C5, C15	0.0005+0.0005 μ F (two gang)	350 V
C6	0.01 μ F	—
C7	0.01 μ F	—
C8	0.0001 μ F	—
*C9	Oscillator SW trimmer	
*C10	Oscillator SW padder	
*C11	Oscillator MW trimmer	
*C12	Oscillator MW padder	
*C13	Oscillator LW trimmer	
*C14	Oscillator LW padder	
*C15, C5	0.0005+0.0005 μ F (two gang)	350 V
C16	0.0001 μ F	350 V
C17	0.01 μ F	350 V
C18	0.01 μ F	350 V
C19	0.1 μ F	350 V
C20	0.00015 μ F	350 V
C21	0.00015 μ F	350 V
C22	0.05 μ F	350 V
C23	2.0 μ F	350 V
C24	5 μ F	—
C25	0.0001 μ F	350 V
C26	0.05 μ F	—
C27	0.002 μ F	500 V
†C28	16 μ F	350 V
†C29	16 μ F	350 V
†C30	25 μ F	12 V
C31	0.01 μ F	—

*Variable

†Electrolytic

TRANSFORMERS

T1, T2	Intermediate frequency transformers (465 Kc/s).	
T3	Output transformer. Load resistance of EL41=7,000 Ω .	
T4	Mains transformer.	
	L1	6.3 V centre tapped 2 A
	L2	250—0—250 V 60 mA
	L3	6.3 V 1 A

INDUCTOR

L4	Smoothing choke. Inductance 12 henries	60 mA
----	--	-------



CIRCUITS

3+1-VALVE D.C./A.C. MAINS-OPERATED SUPERHETERODYNE RECEIVER

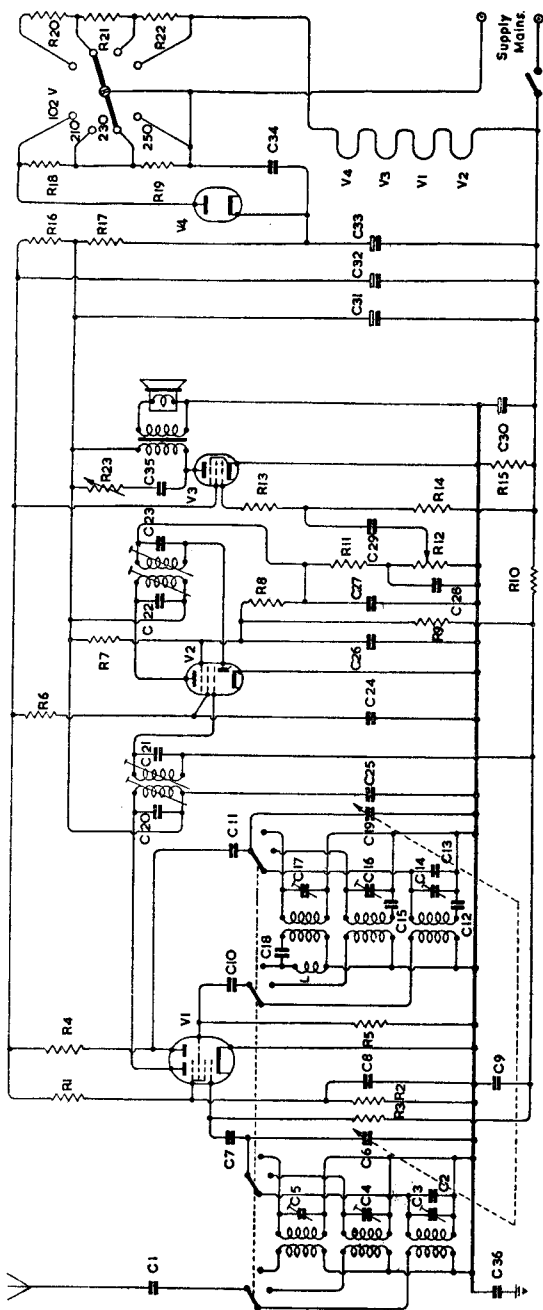

3+1-VALVE D.C./A.C. MAINS-OPERATED SUPERHETERODYNE RECEIVER

This receiver is a 3-valve+rectifier superheterodyne: suitable for operation on long, medium and short wavebands; it is designed for operation on any mains voltage between 102 and 250 V.

An interesting feature of the receiver is the use of grid 3 of V2 as the source of A.V.C. delay voltage; this has the advantage that the I.F. transformer is not loaded by the delay diode, an arrangement which normally results in a degree of modulation distortion. The specified values of R7 and R8 provide a delay voltage of 15 V. It should be noted, however, that in this system only a D.C. potential may be applied to grid 3 and the current to that electrode must be limited to a maximum 10 μ A. This imposes a lower limit of 15 M Ω for R7 and confines the use of grid 3 to supplying the A.V.C. delay voltage.

For optimum performance on short waves, it is essential that the number of turns on the oscillator feedback winding is approximately one half to $\frac{2}{3}$ the number of turns on the tuning winding. Coupling should be tight between these coils. In order to obtain an even response over the whole of the short wave range, L and C18 are used to boost feedback at the L.F. end of the band. In order to achieve this L and C18 must resonate at a frequency lower than the lowest oscillator frequency, for example 4.75 Mc/s for a tuning range of 16-50 metres. The overall sensitivity of the receiver is better than 60 μ V.

RESISTORS

R1	18	K Ω	$\frac{1}{2}$ W
R2	27	K Ω	$\frac{1}{2}$ W
R3	1.0	M Ω	$\frac{1}{4}$ W
R4	22	K Ω	$\frac{1}{2}$ W
R5	47	K Ω	$\frac{1}{2}$ W
R6	47	K Ω	$\frac{1}{2}$ W
R7	22	M Ω	$\frac{1}{2}$ W
R8	2.2	M Ω	$\frac{1}{2}$ W
R9	2.2	M Ω	$\frac{1}{2}$ W
R10	10	M Ω	$\frac{1}{2}$ W
R11	47	K Ω	$\frac{1}{2}$ W
R12	0.5	M Ω	potentiometer
R13	100	K Ω	$\frac{1}{2}$ W
R14	0.82	M Ω	$\frac{1}{2}$ W
R15	140	Ω	1W
R16	1,500	Ω	$\frac{1}{2}$ W
R17	470	Ω	2W
R18	180	Ω	5W
R19	100	Ω	3W
R20	200	Ω	2W
R21	200	Ω	2W
R22	1,074	Ω	12W wirewound
R23	0.1	M Ω	potentiometer

CAPACITORS

C1	1,000	μ F	750 V.
C2	LW	aerial circuit	added cap.
*C3	LW	aerial circuit	trimmer
*C4	MW	aerial circuit	trimmer
*C5	SW	aerial circuit	trimmer
*C6, C19	0.0005+0.0005	μ F (two gang)	
C7	220	μ F	Mica
C8	0.1	μ F	350 V
C9	0.02	μ F	350 V
C10	47	μ F	Mica
C11	220	μ F	Mica
C12	LW	osc. circuit	padder
C13	LW	osc. circuit	added capac.
*C14	LW	osc. circuit	trimmer
C15	MW	osc. circuit	padder
*C16	MW	osc. circuit	trimmer
*C17	SW	osc. circuit	trimmer
C18	SW	osc. circuit	booster
*C19, C6	0.0005+0.0005	μ F (two gang)	
C20	100	μ F	Mica
C21	100	μ F	Mica
C22	100	μ F	Mica

* Variable



GENERAL TECHNICAL DATA

CIRCUITS

3+1-VALVE D.C./A.C. MAINS-OPERATED SUPERHETERODYNE RECEIVER—Continued

VALVES

V1 UCH42
V2 UAF42
V3 UL41
V4 UY41

CAPACITORS—Continued

C23	180	$\mu\mu\text{F}$	Mica
C24	0.1	μF	350 V
C25	0.1	μF	350 V
C26	0.02	μF	350 V
C27	47	$\mu\mu\text{F}$	Mica
C28	47	$\mu\mu\text{F}$	Mica
C29	0.002	μF	350 V
†C30	50	μF	25 V
†C31 } †C32 }	25+25	μF	275 V
†C33	40	μF	350 V
C34	0.02	μF	750 V
C35	0.05	μF	350 V
C36	0.02	μF	750 V

†Electrolytic

TRANSFORMERS

T1, T2 Intermediate frequency transformer (465 Kc/s).
T3 Output transformer.
Load resistance of UL41 3,000 ohms.

INDUCTOR

L Short wave booster winding.

The values of components which are not stated are dependent upon type of coil pack employed.



3-VALVE BATTERY-OPERATED GRAMOPHONE AMPLIFIER

This amplifier is suitable for the reproduction of speech and music. A variable tone control is provided in order that the quality of reproduction may be adjusted to meet individual requirements. The value of the capacitor C2 will affect the bass response and its value is dependent upon the type of inductor T1. A typical value for C2 is 0.05 μF .

When using a 90-V H.T. battery, an output power of 450 mW may be obtained with an input drive voltage of 200 mV. The total H.T. current drain under these conditions will be about 7.0 mA.

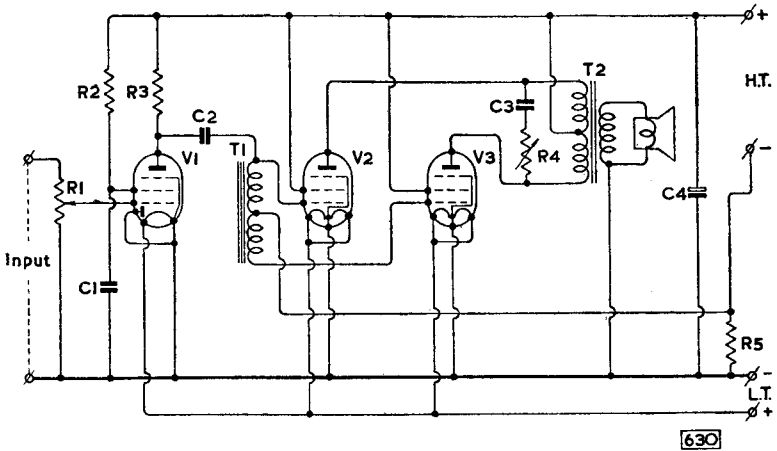

RESISTORS

R1	0.5 M Ω	potentiometer	
R2	680 K Ω		$\frac{1}{4}$ W
R3	100 K Ω		$\frac{1}{4}$ W
R4	100 K Ω	potentiometer	
R5	1 K Ω		$\frac{1}{4}$ W

CAPACITORS

C1	0.05	μF
C2	0.05	μF
C3	0.005	μF
*C4	8	μF

*Electrolytic

VALVES

V1	DAF91
V2	DL94
V3	DL94

TRANSFORMERS

T1	Push-pull input choke matched to 100K Ω
T2	Output transformer $R_{a-a} = 14,000 \Omega$ (ratio dependent upon impedance of speaker).

H.T. voltage 90 V

L.T. 1.5 V, 250 mA



3-WATT A.C. MAINS-OPERATED A.F. AMPLIFIER WITH SELECTIVE FEEDBACK

The design of this amplifier is such that good quality reproduction of gramophone recordings is possible, at a maximum output of over 3 watts.

Bass and treble tone controls are incorporated in the feedback circuit. Care must be taken when connecting up the feedback loop to ensure that the voltage fed back is in phase with the input voltage. If the phase relationship is incorrect the amplifier will oscillate.

The recommended value of R1 is suitable for all normal armature pickups. Its value may, however, be changed to suit any particular type of pickup employed.

RESISTORS

R1	220 K Ω	potentiometer	
R2	220 K Ω		$\frac{1}{2}$ W
R3	2,200 Ω		$\frac{1}{2}$ W
R4	56 Ω		$\frac{1}{2}$ W
R5	1,000 Ω		$\frac{1}{2}$ W
R6	25 K Ω	potentiometer	
R7	1.0M Ω		$\frac{1}{2}$ W
R8	3,900 Ω		$\frac{1}{2}$ W
R9	47 K Ω		$\frac{1}{2}$ W
R10	100 K Ω	potentiometer	
R11	680 K Ω		$\frac{1}{2}$ W
R12	1,000 Ω		$\frac{1}{2}$ W
R13	170 Ω		$\frac{1}{2}$ W

CAPACITORS

*C1	100 μ F	6 V
C2	0.05 μ F	350 V
C3	0.05 μ F	350 V
*C4	4 μ F	350 V
C5	0.02 μ F	500 V
*C6	50 μ F	25 V
*C7	16 μ F	350 V
*C8	16 μ F	350 V
C9	0.1 μ F	350 V

*Electrolytic

VALVES

V1	EF40
V2	EL41
V3	EZ40

INDUCTORS

Inductance—10 henries

Current rating 40 mA

TRANSFORMERS

T1	Output transformer	Primary impedance 7,000 Ω
		Primary current rating 36mA
		Secondary impedance 0-4-8-15 Ω
T2	Mains transformer	
	Rating 250-0-250	V _{rms} 60 mA
		6.3 V 2 A centre-tapped
		6.3 V 1 A



CIRCUITS

10-WATT D.C./A.C. MAINS-OPERATED PUSH-PULL A.F. AMPLIFIER

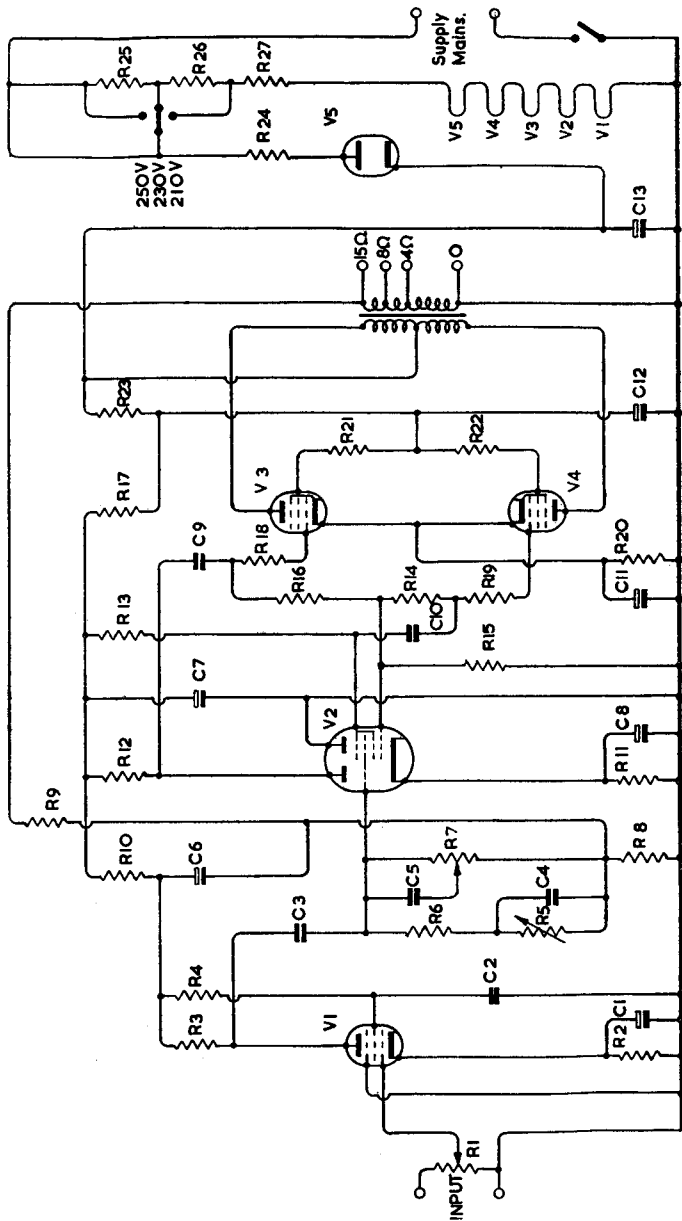

10-WATT D.C./A.C. MAINS-OPERATED PUSH-PULL A.F. AMPLIFIER

This amplifier is suitable for the reproduction of speech and music and is capable of providing an audio output of approximately 10 watts peak for an input to the grid of V1 of 70 mV. Bass and treble tone controls incorporated between V1 and V2 provide a wide range of tone correction. Care must be taken in the construction of this stage to ensure that if a metal-cased component is used for C6, the case is not connected to the chassis.

In order to eliminate the switching of mains voltage dropping resistors it is possible over a supply voltage range 200–250 V to replace R25, R26 and R27 by a Philips barretter type C1.

RESISTORS

R1	0.5	M Ω	potentiometer	—
R2	4,700	Ω	$\frac{1}{2}$ W	10%
R3	0.47	M Ω	$\frac{1}{2}$ W high stability	10%
R4	2.2	M Ω	$\frac{1}{2}$ W	10%
R5	2.0	M Ω	potentiometer	—
R6	0.1	M Ω	$\frac{1}{2}$ W	10%
R7	2.0	M Ω	potentiometer	—
R8	100	Ω	$\frac{1}{2}$ W	10%
R9	1,200	Ω	$\frac{1}{2}$ W	10%
R10	47	K Ω	$\frac{1}{2}$ W	10%
R11	1,200	Ω	$\frac{1}{2}$ W	10%
R12	0.1	M Ω	$\frac{1}{2}$ W	10%
R13	0.1	M Ω	$\frac{1}{2}$ W	10%
R14	0.47	M Ω	$\frac{1}{2}$ W high stability	2%
R15	0.27	M Ω	$\frac{1}{2}$ W	10%
R16	0.33	M Ω	$\frac{1}{2}$ W high stability	2%
R17	10	K Ω	$\frac{1}{2}$ W	10%
R18	1,000	Ω	$\frac{1}{2}$ W	20%
R19	1,000	Ω	$\frac{1}{2}$ W	20%
R20	220	Ω	2W wirewound	5%
R21	47	Ω	$\frac{1}{2}$ W	20%
R22	47	Ω	$\frac{1}{2}$ W	20%
R23	1,000	Ω	1W	10%
R24	180	Ω	5W wirewound	10%
R25	200	Ω	5W wirewound	10%
R26	200	Ω	5W wirewound	10%
R27	624	Ω	15W wirewound	5%

CAPACITORS

†C1	100	μ F	6 V	—
C2	0.1	μ F	350 V	20%
C3	0.02	μ F	500 V	20%
C4	0.005	μ F	350 V	10%
C5	0.002	μ F	350 V	10%
†C6	4	μ F	350 V	—
†C7	4	μ F	350 V	—
†C8	100	μ F	6 V	—
C9	0.02	μ F	500 V	20%
C10	0.02	μ F	500 V	20%
†C11	50	μ F	25 V	—
†C12	40	μ F	350 V	—
†C13	40	μ F	350 V	—
			†Electrolytic	

VALVES

V1	UAF42
V2	UCH42
V3	UL41
V4	UL41
V5	UY41

TRANSFORMER

T1 Push-pull output transformer. Effective primary impedance 5,500 Ω (anode to anode). Secondary 0–4–8–15 Ω .



CIRCUITS

10 OR 30-WATT A.C. MAINS-OPERATED PUSH-PULL A.F. AMPLIFIER

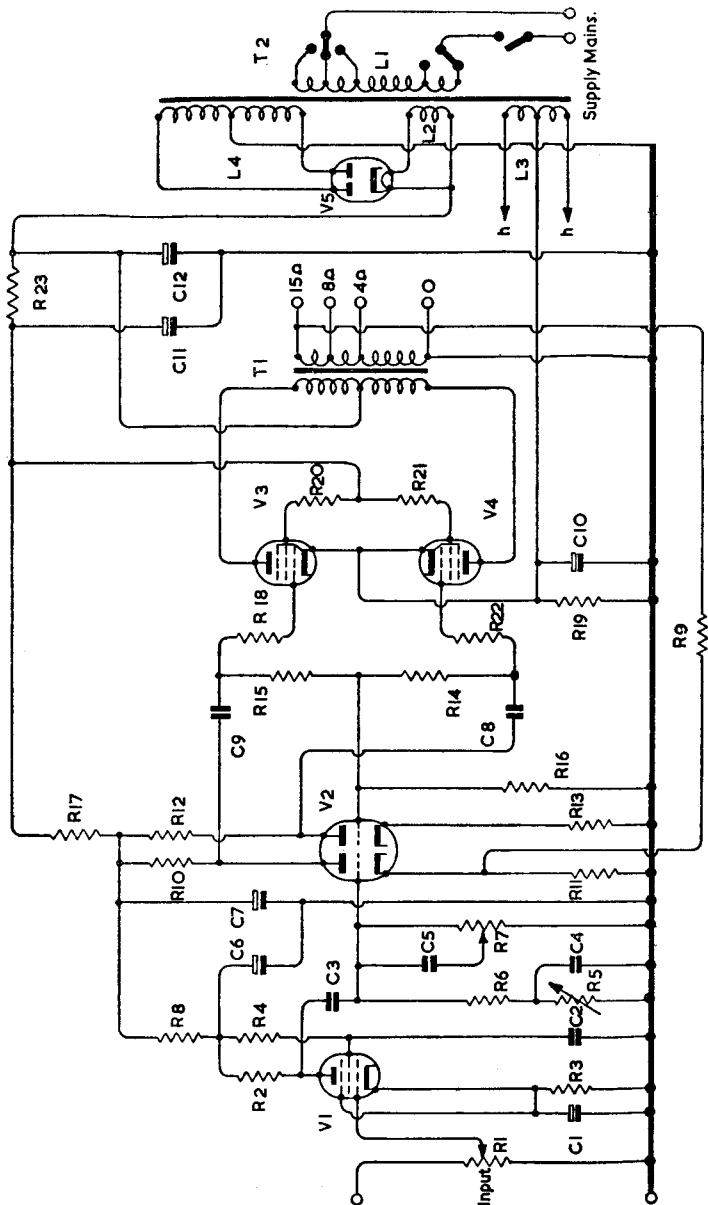

10-WATT A.C. MAINS-OPERATED PUSH-PULL A.F. AMPLIFIER

This amplifier is intended for the reproduction of speech and music and is capable of providing an output power of 10 watts for an input to the grid of V1 of 25mV_(r.m.s.).

The input lead to V1 must be as short as possible and should consist of a length of low capacity screened cable.

In order to minimise hum from the EF40 a good high-resistance valveholder must be used to avoid leakage in the valveholder.

RESISTORS

R1	500	K Ω	—	P
R2	470	K Ω	$\frac{1}{2}$ W	—
R3	4,700	Ω	$\frac{1}{2}$ W	—
R4	1.8	M Ω	$\frac{1}{2}$ W	—
R5	2.0	M Ω	—	P
R6	100	K Ω	$\frac{1}{2}$ W	—
R7	2.0	M Ω	—	P
R8	47	K Ω	$\frac{1}{2}$ W	—
R9	39	K Ω	$\frac{1}{2}$ W	—
R10	100	K Ω	$\frac{1}{2}$ W	—
R11	2,200	Ω	$\frac{1}{2}$ W	—
R12	100	K Ω	$\frac{1}{2}$ W	—
R13	2,200	K Ω	$\frac{1}{2}$ W	—
R14	270	K Ω	$\frac{1}{2}$ W	2%
R15	220	K Ω	$\frac{1}{2}$ W	2%
R16	220	K Ω	$\frac{1}{2}$ W	—
R17	10	K Ω	$\frac{1}{2}$ W	—
R18	1,000	Ω	$\frac{1}{2}$ W	20%
R19	200	Ω	2W w	5%
R20	47	Ω	$\frac{1}{2}$ W	20%
R21	47	Ω	$\frac{1}{2}$ W	20%
R22	1,000	Ω	$\frac{1}{2}$ W	20%
R23	1,000	Ω	2W	—

CAPACITORS

†C1	100	μF	6V	—
C2	0.05	μF	500V	20%
C3	0.02	μF	500V	20%
C4	0.005	μF	350V	10%
C5	0.002	μF	350V	10%
†C6	4	μF	450V	—
†C7	4	μF	450V	—
C8	0.02	μF	500V	20%
C9	0.02	μF	500V	20%
†C10	50	μF	25V	—
†C11	16	μF	450V	—
†C12	32	μF	450V	—

†Electrolytic

VALVES

V1	EF40.
V2	ECC40.
V3	EL41.
V4	EL41.
V5	EZ40.

All values 10% unless otherwise stated.

P—Potentiometer (Log).

w—wirewound.

TRANSFORMERS

Output transformer T1 : Effective anode-to-anode load for two EL41 is 9,000 Ω.

Mains transformer T2 :

L1 Primary

L3 6.3 V c.t. 3 A

L2 6.3 V

L4 300-0-300

0.6 A

100 mA



CIRCUITS

30-WATT A.C. MAINS-OPERATED PUSH-PULL A.F. AMPLIFIER

This amplifier is intended for the reproduction of speech and music and is capable of providing an output power of 30 watts. The signal input voltage for maximum output power is about 50 mV (rms). This enables the amplifier to be fed directly from most types of gramophone pick-up.

The input lead to V1 must be as short as possible and should consist of a length of low capacity screened cable.

In order to limit the peak current in V5 the effective resistance (R_t) in each anode circuit should be 100 ohms minimum. This resistance consists of the resistance of half the H.T. secondary winding plus that reflected into one half of the secondary from the primary. The value of R_t is given by :

$$R_t = R_s + N^2 R_p$$

where R_s = resistance of half secondary winding

R_p = resistance of primary winding

N = turns ratio of half secondary to primary windings

Negative feedback is obtained from the output transformer secondary and is fed back via R9 to the cathode of the input section for V2.

The ripple current in the reservoir capacitor C12 is 220 mA. This component must be of a type suitable to withstand this current.

RESISTORS

R1	500	K Ω	P	
R2	470	K Ω	1W H.S.	
R3	4,700	Ω	½W	
R4	2.2	M Ω	½W	
R5	2.0	M Ω	P.	
R6	100	K Ω	½W	
R7	2.0	M Ω	P.	
R8	47	K Ω	½W	
R9	22	K Ω	½W	
R10	100	K Ω	½W	
R11	2,200	Ω	½W	
R12	100	K Ω	½W	
R13	2,200	Ω	½W	
R14	270	K Ω	½W H.S.	2%
R15	220	K Ω	½W H.S.	2%
R16	220	K Ω	½W	
R17	10	K Ω	½W	
R18	1,000	Ω	½W	20%
R19	250	Ω	6W w	5%
R20	47	Ω	½W	20%
R21	47	Ω	½W	20%
R22	1,000	Ω	½W	20%
R23	1,000	Ω	2W	

CAPACITORS

†C1	100	μF	6 V	—
C2	0.05	μF	500 V	20%
C3	0.02	μF	500 V	20%
C4	0.005	μF	500 V	10%
C5	0.002	μF	500 V	10%
†C6	4	μF	450 V	—
†C7	4	μF	450 V	—
C8	0.05	μF	500 V	20%
C9	0.05	μF	500 V	20%
†C10	50	μF	50 V	—
†C11	16	μF	450 V	—
†C12	32	μF	450 V	—

†Electrolytic

VALVES

V1	EF37A
V2	ECC33
V3	EL37
V4	EL37
V5	GZ32

All values 10% unless otherwise stated.

P—Potentiometer (Log.). H.S.—High stability. w—wirewound.

TRANSFORMERS

Output transformer T1 : Effective anode-to-anode load for two EL37 is 5,000 Ω.

Mains transformer T2 :

L1	Primary	L2	5 V	2 A	
L3	6.3 V c.t.	4A	L4	350-0-350	170 mA



AMPLIFIER, TIME BASE AND POWER SUPPLY UNIT FOR OSCILLOSCOPE

By means of the time base generator, amplifier and power supply unit described below, a simple but efficient oscilloscope may be constructed for the visual examination of a large variety of waveforms.

The use of the two amplifiers enables ample deflection to be obtained in both axes under all normal conditions.

THE AMPLIFIERS

The horizontal and vertical amplifiers are similar in construction and are of the triphase type. This enables an output voltage balanced on either side of earth to be fed to the deflection plates of the cathode ray tube, thus avoiding deflection defocusing. The grid and anode leads to the valves should be as short as possible in order to avoid stray capacitive coupling. When used in conjunction with the 3-inch cathode ray tube, Type DG7-5, the amplifier will enable a deflection sensitivity of 1.25 cm/V (D.C.) to be obtained. The response of the amplifier is substantially linear up to 2 Mc/s.

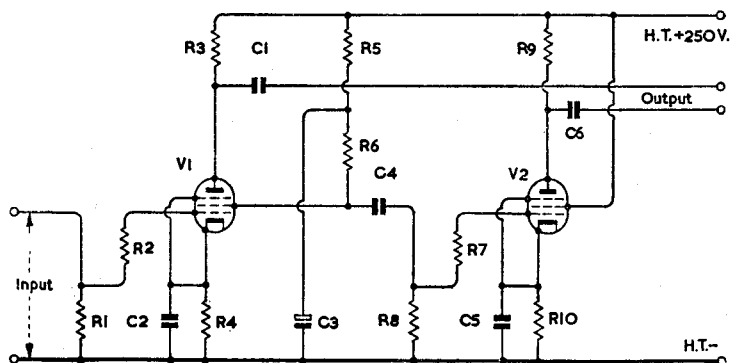

RESISTORS

R1	1	M Ω
R2	150	Ω
R3	10	K Ω
R4	180	Ω
R5	10	K Ω
R6	1.2	K Ω
R7	150	Ω
R8	1	M Ω
R9	10	K Ω
R10	180	Ω

All resistors are rated at ½W.

CAPACITORS

C1	0.1	μF	350 V
C2	1,500	μμF	—
*C3	32	μF	350 V
C4	0.22	μF	350 V
C5	1,500	μμF	—
C6	0.1	μF	350 V

*Electrolytic

VALVES

V1, V2 EF42



GENERAL TECHNICAL DATA

CIRCUITS

AMPLIFIER, TIME BASE AND POWER SUPPLY UNIT FOR OSCILLOSCOPE—Continued.

TIME BASE GENERATOR

The time base generator is of the single-valve type and is capable of providing a linear sweep voltage over the frequency range 7.5 c/s—30 Kc/s, with the choice of capacitors given on the circuit diagram. The capacitors are selected in turn by means of a single-pole seven-way rotary switch.

Provision is made for synchronising the time base frequency with that of the waveform under examination by applying a fraction of the latter to the suppressor grid of the valve.

FREQUENCY RANGE

C2	Frequency Range
220 $\mu\mu\text{F}$	7.5 Kc/s—30 Kc/s
680 $\mu\mu\text{F}$	2.5 Kc/s—10 Kc/s
2,200 $\mu\mu\text{F}$	750 c/s — 3 Kc/s
6,800 $\mu\mu\text{F}$	250 c/s — 1 Kc/s
0.022 μF	75 c/s —300 c/s
0.068 μF	25 c/s —100 c/s
0.22 μF	7.5 c/s — 30 c/s

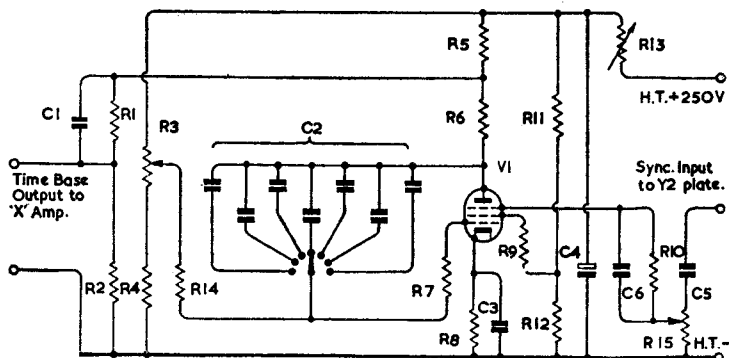

RESISTORS

R1	220	K Ω	1W
R2	100	K Ω	$\frac{1}{2}$ W
**R3	250	K Ω	
R4	56	K Ω	$\frac{1}{2}$ W
R5	39	K Ω	1W
R6	4.7	K Ω	$\frac{1}{2}$ W
R7	150	Ω	$\frac{1}{2}$ W
R8	470	Ω	$\frac{1}{2}$ W
R9	39	K Ω	1W

R10	1.5 M Ω	$\frac{1}{2}$ W	
R11	22	K Ω	1W
R12	82	K Ω	1W
*R13	50	K Ω	
	(amplitude control)		
R14	560	K Ω	$\frac{1}{2}$ W
**R15	0.5 M Ω		
	*Wirewound		
	**Potentiometer		

CAPACITORS

C1	5 $\mu\mu\text{F}$	—
C2	See notes above	
C3	560 $\mu\mu\text{F}$	—
†C4	32 μF	320 V
C5	0.2 μF	—
C6	5 $\mu\mu\text{F}$	—
	†Electrolytic	

VALVE
V1 EF42



**AMPLIFIER, TIME BASE AND POWER SUPPLY UNIT
FOR OSCILLOSCOPE—Continued**

POWER SUPPLY

This is a power pack of conventional type using a full-wave rectifier capable of delivering an output of 60 mA at approximately 250 V.

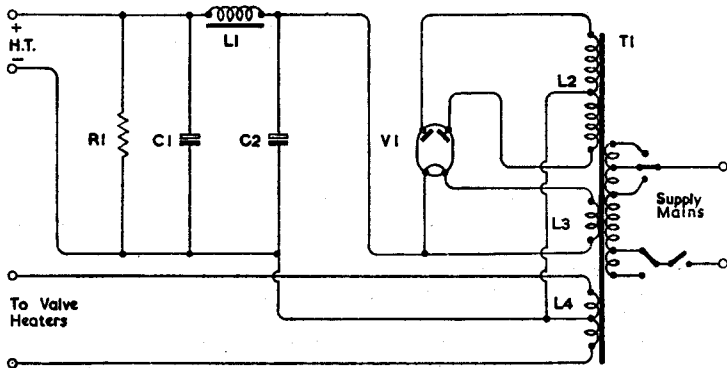

RESISTOR

R1 50 K Ω 2W

CAPACITORS

†C1 32 μ F 320 V

†C2 16 μ F 450 V

†Electrolytic

VALVE

V1 AZ31

INDUCTOR

L1 10 henries 60 mA

MAINS TRANSFORMER

L2 250-0-250 60 mA

L3 4 V 1 A

L4 6.3 V 2 A c.t.



CIRCUITS

VOLTAGE-REGULATED POWER SUPPLY UNIT

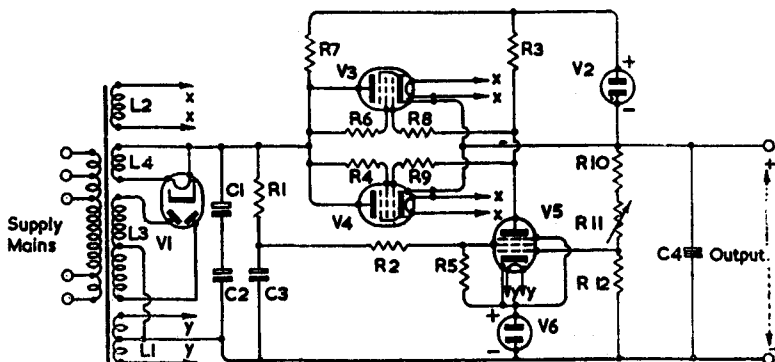

The circuit diagram shows a high stability voltage-regulated power supply unit capable of providing a high degree of stabilisation over the range of 150-300 V at 125 mA.

The output current is limited at low voltage output by the maximum anode dissipation of V3 and V4. When the output voltage approaches 300 V the limit is set by the start of I_{g1} in V3 and V4.

Stability from minimum to maximum load current, at an output voltage of 250 V is better than 0.5 V, and under these conditions the hum output is less than 25 mV. If only one heater winding is available for the control and stabilising valves, it should be utilised as shown below.

RESISTORS

R1	33	K Ω	2W
R2	22	K Ω	2W
R3	220	K Ω	$\frac{1}{2}$ W
R4	47	Ω	$\frac{1}{4}$ W
R5	15	K Ω	1W
R6	47	Ω	$\frac{1}{4}$ W
R7	68	K Ω	2W
R8	1	K Ω	$\frac{1}{4}$ W
R9	1	K Ω	$\frac{1}{4}$ W
R10	7.5	K Ω	2W wirewound
R11	20	K Ω	wirewound potentiometer
R12	10	K Ω	2W wirewound

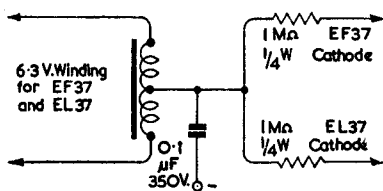

TRANSFORMER

L1	6.3 V	centre tapped
L2	6.3 V	3 A
L3	375-0-375	150 mA
L4	5 V	2 A

CAPACITORS

*C1	60 μ F	350 V
*C2	60 μ F	350 V
*C3	4 μ F	450 V
*C4	32 μ F	450 V

*Electrolytic

VALVES

V1	GZ32
V2	7475
V3	EL37
V4	EL37
V5	EF37
V6	85A1



PORTABLE BATTERY-OPERATED PHOTOGRAPHIC FLASH EQUIPMENT

The circuit below is of a portable unit intended for the production of high intensity short-duration luminous flashes of a type suitable for studio or press photography.

The reader is referred to pages 171 for general operating data on the flash tubes which may be incorporated in this type of apparatus.

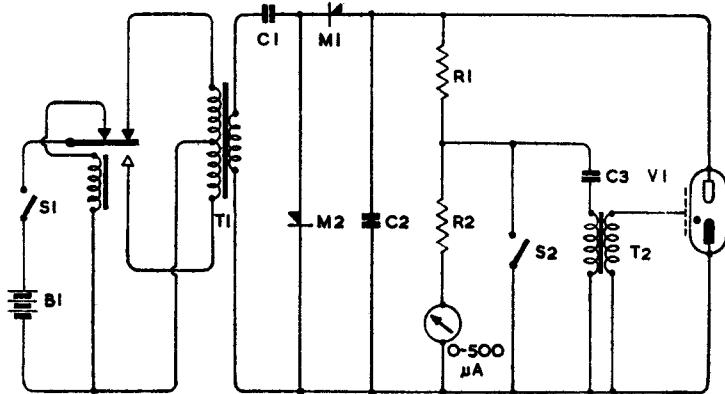

RESISTORS

R1	10	MΩ
R2	0.68	MΩ
B1	6.0	V battery or accumulator

TUBE

V1 LSD3/LSD3A

RECTIFIERS

M1	{ Metal rectifiers Open circuit input voltage 900 $V_{r.m.s}$ Mean output current 8 mA
M2	

CAPACITORS

C1	0.05	μF	1,500	V
*C2	33	μF	2,500	V
C3	1.0	μF	500	V

This value of capacitor will enable a flash duration of approximately 150 μSec. to be obtained.

SWITCHES

- S1 Charging switch
S2 Firing switch

TRANSFORMERS

- T1 Primary 6-0-6 V Secondary 900 $V_{r.m.s}$
T2 Trigger transformer, minimum output; 3,000 V



