

Western Electric

102F Vacuum Tube

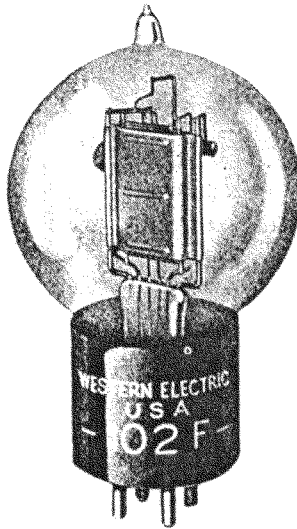

Classification—Filamentary, voltage amplifier triode

The 102F tube is designed for the same class of service as the 102D tube but operates with a lower filament power consumption.

Applications

Audio-frequency voltage amplifier.
Detector or modulator.

Dimensions—Dimensions, outline diagrams of the tube and base, and the arrangement of the electrode connections to the base terminals are shown in Figures 1 and 2.

Base—Medium, four-pin, bayonet type having special contact metal at the ends of the contact pins.

Socket—Four-contact, bayonet-slot type, preferably provided with contact-metal contacts, such as the Western Electric 100L for front of panel mounting or 100R for rear of panel mounting.

Mounting Positions—Either vertical or horizontal. If mounted in a horizontal position, the plane of the filament, which is indicated in Figure 2, should be vertical.

Average Direct Interelectrode Capacitances

	<u>A</u>	<u>B</u>	<u>C</u>
Grid to plate, $\mu\mu\text{f.}$	9.2	9.0	9.0
Grid to filament, $\mu\mu\text{f.}$	3.8	4.3	4.6
Plate to filament, $\mu\mu\text{f.}$	1.5	2.9	3.2

Column A—Based tube without socket.

Column B—Tube alone when measured in 100L socket mounted on metal plate; socket and mounting plate connected to filament.

Column C—Tube alone when measured in 100R socket mounted in metal plate; socket and mounting plate connected to filament.

Filament Rating

Filament current.....	0.50 ampere, d.c.
Nominal filament voltage.....	2.1 volts

The filament of this tube is designed to operate on a current basis and should be operated at as near the rated current as is practicable.

Characteristics—Plate current characteristics of a typical 102F tube are shown in Figure 3 as functions of grid voltage for several values of plate voltage. The grid and plate voltages are measured from the negative end of the filament. Corresponding amplification factor, plate resistance, and transconductance characteristics are given in Figures 4, 5 and 6, respectively. Plate current characteristics as functions of plate voltage are shown in Figure 7 for several values of grid voltage.

Operating Conditions and Output—Permissible operating plate and grid voltages are included within the area, ABCD, in Figure 3. Amplification factor, plate resistance, transconductance, and performance data are given in the table on page 3 for a number of typical operating conditions represented by selected points within this area. The less severe operating conditions should be selected in preference to maximum operating conditions wherever possible. The life of the tube at maximum conditions may be shorter than at less severe conditions.

The performance data include the fundamental output voltage in peak volts and the second and third harmonic levels in decibels below the fundamental for values of load resistance R , equal to one, three, and five times the plate resistance, r_p . The peak value of the sinusoidal input voltage, E_{gm} , which gives the indicated output voltage, E_{pm} , and harmonic levels F_{2m} and F_{3m} , in each case, is numerically equal to the grid bias. For a smaller input voltage, E_g , the approximate levels may be computed from the following relations.

$$E_p = E_{pm} \frac{E_g}{E_{gm}}$$

$$F_2 = F_{2m} + 20 \log_{10} \frac{E_{gm}}{E_g}$$

$$F_3 = F_{3m} + 40 \log_{10} \frac{E_{gm}}{E_g}$$

TABLE

Plate Voltage Volts	Grid Bias Volts	Plate Current Milli-amperes	Amplification Factor	Plate Resistance Ohms r_p	Trans-conductance Micro-mhos	Input Voltage Peak Volts	Load Resistance R	Output Voltage Peak Volts	Second Harmonic db	Third Harmonic db
130	-2.0	0.45	29.7	69000	430	2.0	$R = r_p$	26	21	40
							$R = 3r_p$	39	25	44
							$R = 5r_p$	42	26	45
130	-1.5	0.7	30.1	54000	550	1.5	$R = r_p$	21	26	48
							$R = 3r_p$	32	32	55
							$R = 5r_p$	34	33	55
130	-1.0	1.0	30.5	45000	670	1.0	$R = r_p$	15	32	60
							$R = 3r_p$	21	38	65
							$R = 5r_p$	24	40	65
160	-3.0	0.45	29.5	70000	420	3.0	$R = r_p$	40	18	37
							$R = 3r_p$	57	22	40
							$R = 5r_p$	63	23	41
160	-2.0	1.0	30.3	46000	660	2.0	$R = r_p$	29	26	47
							$R = 3r_p$	43	32	55
							$R = 5r_p$	47	33	55
*160	-1.0	1.75	30.8	36000	860	1.0	$R = r_p$	16	37	60
							$R = 3r_p$	22	43	65
							$R = 5r_p$	25	46	65
*190	-3.0	1.0	30.1	46000	650	3.0	$R = r_p$	42	22	40
							$R = 3r_p$	62	28	47
							$R = 5r_p$	66	30	50
*190	-2.0	1.75	30.6	36000	850	2.0	$R = r_p$	30	30	50
							$R = 3r_p$	43	36	60
							$R = 5r_p$	48	39	60

*Maximum operating conditions.

Microphonic Noise—With a plate voltage of 130 volts, a grid bias of -1.5 volts, and a load resistance of 100,000 ohms, the mean microphonic noise output level of the 102F tube, measured in a laboratory reference test set, is 20 decibels below 1 volt. The range of levels of individual tubes extends from 9 to 36 decibels below 1 volt. Since microphonic noise depends on the type and intensity of the mechanical disturbance which produces it, the values given here are useful chiefly for comparison with the levels of other tubes which have been tested in the same way.

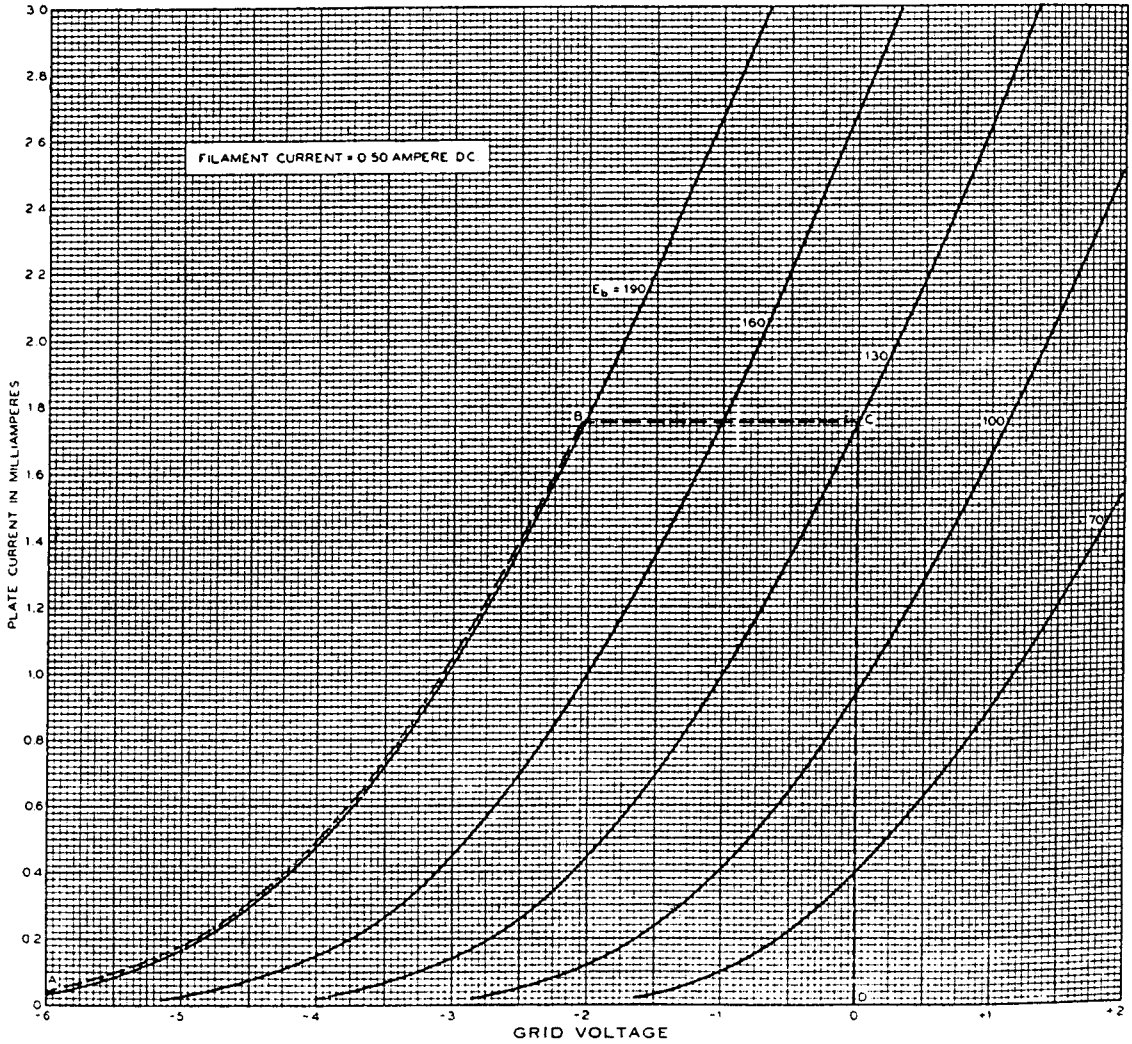
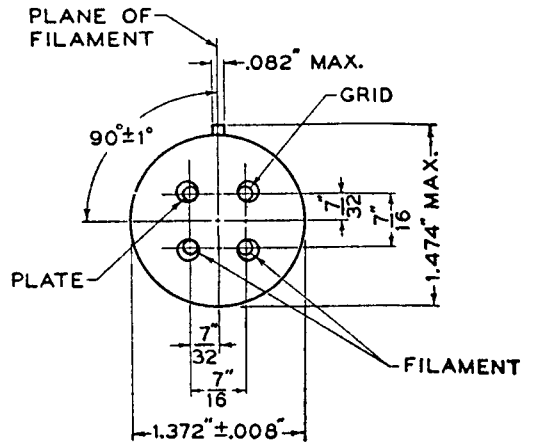
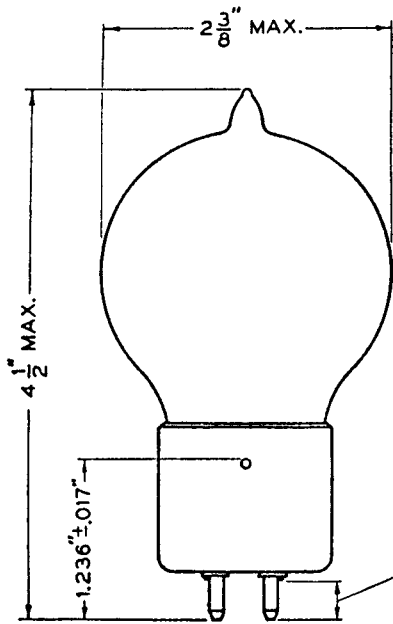

FIG. 3

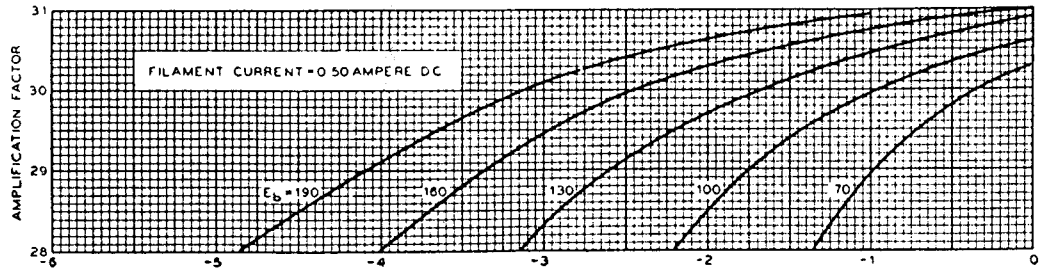

FIG. 4

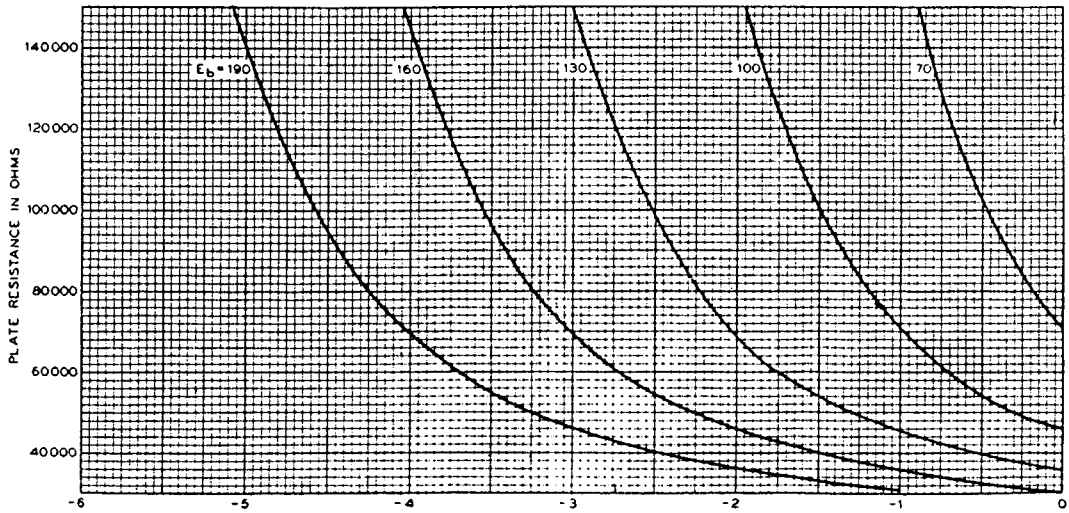

FIG. 5

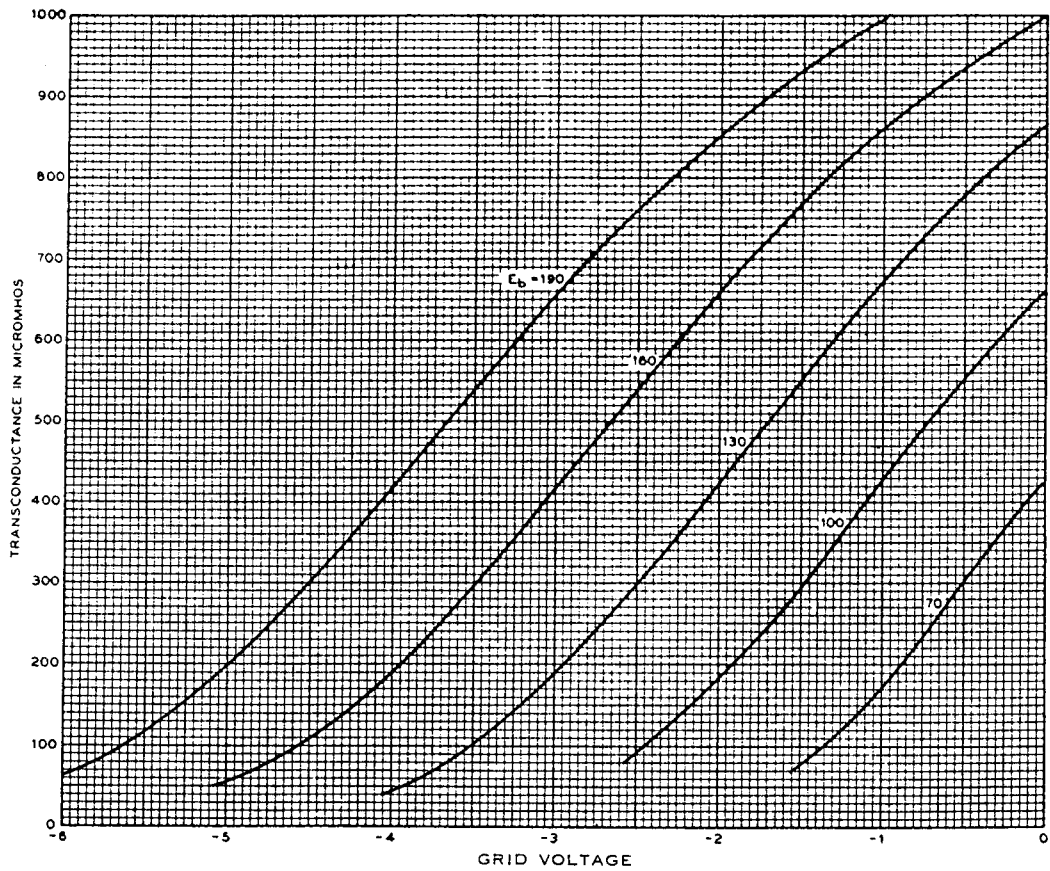

FIG. 6

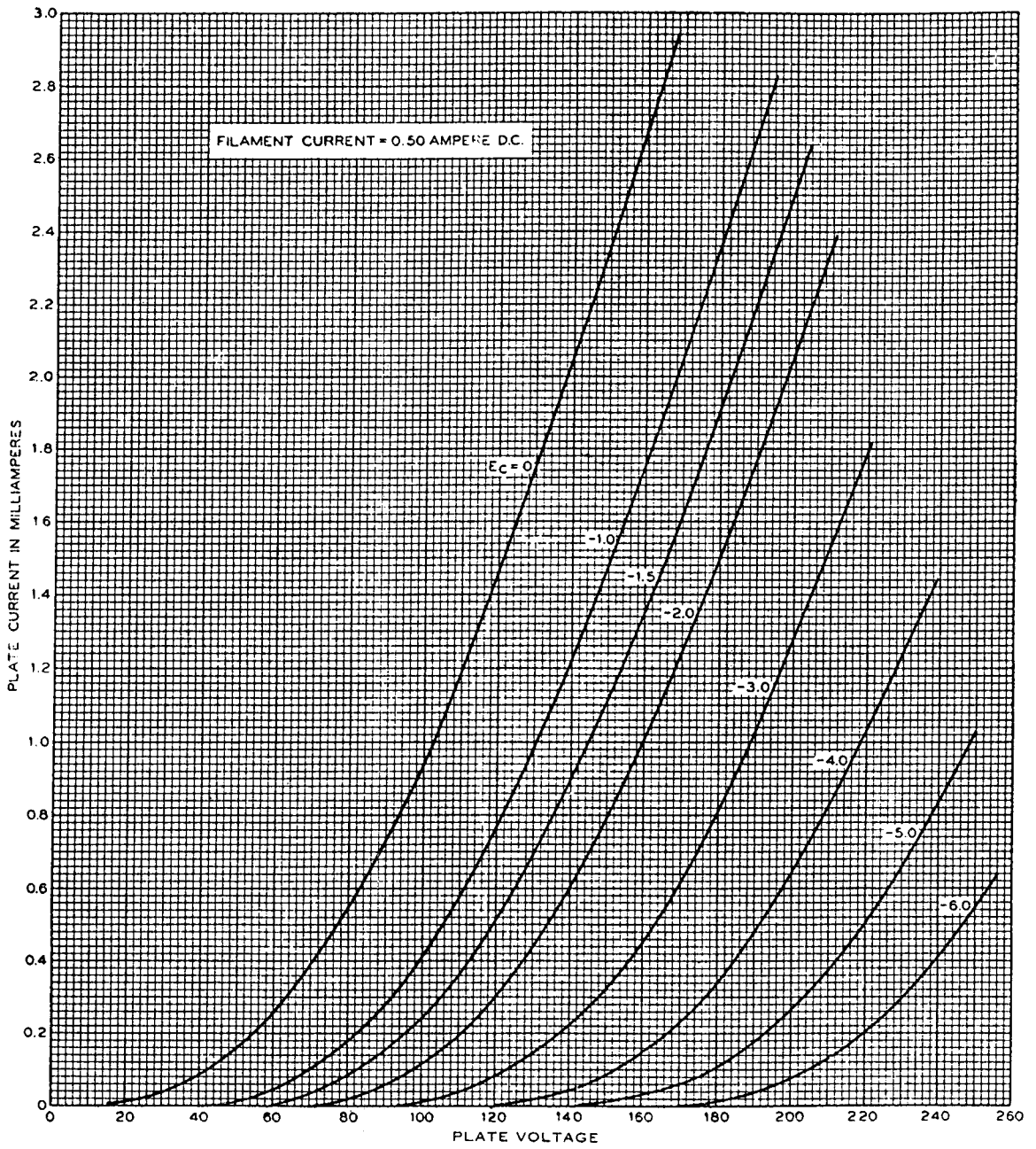

FIG. 7